



Volume II - HLM

Handling and Loading Procedures

Ed. 2 Rev. 18

 Volume II HLM	INTRODUCTION	0.1	Page 1
	HLM - PURPOSE AND SCOPE	Ed 2/20 apr 2022	

0.1 HLM - PURPOSE AND SCOPE

ITA Handling and Loading Manual (HLM) complies with AIR-OPS.

The manual is intended to supply the basic standards and further information required for proper operational ground handling of Company aircraft.

Operations are to be conducted in compliance with the procedures and limitations contained in the manual or extracts thereof and the current regulations of the competent Authorities, consistent with good judgement.

The operative procedures described on IATA IGOM chapter 4 are also accepted in lieu of Company ones, with exception of subchapter " Safety during Refuelling/Defuelling".

In some cases it may be necessary to deviate from the HLM procedures due to local rules, regulations or other reasons. Deviations are acceptable, except when such deviations would affect either safety or the handling at other stations en-route. Any deviation must be approved by ITA appropriate department.

Requests for approval must be supported by a Risk Assessment showing that safety will not be jeopardized and the operational ground handling of aircraft is not affected.

When the deviation is approved by the appropriate department, a Letter of Approval (LoA) will be issued.

Notes are presented in a separate box of this type:

Note: Specially designed belt loaders as ramp snake or Powerstow are allowed to be positioned inside the cargo hold.

Cautions are presented in a separate box. There are two different types of caution



Caution:
Representing a general caution.



Caution:
Representing a personal danger for the employee.

 Volume II HLM	INTRODUCTION	0.2	Page 1
	GENERAL INDEX	Ed 2 Rev 18/26 feb 26	

0.2 GENERAL INDEX

0.1	HLM - PURPOSE AND SCOPE	1
0.2	GENERAL INDEX	1
0.3	LIST OF EFFECTIVE PAGES	1
0.4	REVISION HIGHLIGHTS VOL. II	1

Cap. 1 REPORTING SYSTEM

1.1	REPORTING SYSTEM & GROUND SAFETY REPORT (GSR)	1
------------	--	----------

Cap. 2 MESSAGES

2.1	GENERAL	1
2.2	LOAD DISTRIBUTION MESSAGE (LDM)	1
2.2.1	GENERAL	1
2.2.2	LDM FORMAT EXAMPLE	1
2.3	CONTAINER AND PALLET DISTRIBUTION MESSAGE (CPM)	1
2.3.1	GENERAL	1
2.3.2	CPM FORMAT EXAMPLE	1
2.4	UNIT LOAD DEVICE CONTROL MESSAGE (UCM)	1
2.4.1	GENERAL	1
2.4.2	UCM FORMAT EXAMPLE	1
2.5	AIRCRAFT MOVEMENT MESSAGE (MVT)	1
2.5.1	GENERAL	1
2.5.2	MVT - DEPARTURE FORMAT EXAMPLE (DEP)	1
2.5.3	MVT - ARRIVAL FORMAT EXAMPLE (ARR)	2
2.5.4	MVT - DELAY FORMAT EXAMPLE (DLY)	2
2.5.5	MVT - INDEFINITE DELAY FORMAT EXAMPLE (NXT)	2
2.5.6	MVT - RETURN TO RAMP FORMAT EXAMPLE (RET)	3

Cap. 3 SPECIAL LOADS

3.1	INTRODUCTION	1
3.2	DANGEROUS GOODS	1
3.2.1	GENERAL	1
3.2.2	CLASSIFICATION	3

 Volume II HLM	INTRODUCTION	0.2	Page 2
	GENERAL INDEX	Ed 2 Rev 18/26 feb 26	

3.2.2.1	Class 1 - Explosives	3
3.2.2.2	Class 2 - Gases	4
3.2.2.2.1	Division 2.1 - RFG	4
3.2.2.2.2	Division 2.2 - RNG/RCL.....	5
3.2.2.2.3	Division 2.3 - RPG	5
3.2.2.3	Class 3 - Flammable Liquids	5
3.2.2.4	Class 4 - Flammable Solids	6
3.2.2.4.1	Division 4.1 - RFS.....	6
3.2.2.4.2	Division 4.2 - RSC	6
3.2.2.4.3	Division 4.3 - RFW.....	6
3.2.2.5	Class 5 - Oxidizing Substance; Organic Peroxide	7
3.2.2.5.1	Division 5.1 - ROX.....	7
3.2.2.5.2	Division 5.2 - ROP	7
3.2.2.6	Class 6 - Toxic Substance; Infectious Substance	7
3.2.2.6.1	Division 6.1 - RPB	7
3.2.2.6.2	Division 6.2 - RIS.....	8
3.2.2.7	Class 7 - Radioactive Material	8
3.2.2.7.1	Category I White - RRW	8
3.2.2.7.2	Category II Yellow - Transport index not exceeding 1.0 - RRY	8
3.2.2.7.3	Category III Yellow - Transport index between 1.1 and 10 - RRY	9
3.2.2.7.4	Category Fissile.....	9
3.2.2.8	Class 8 - Corrosive	9
3.2.2.9	Class 9 - Miscellaneous Dangerous Goods	10
3.2.2.9.1	RMD	10
3.2.2.9.2	RSB	10
3.2.2.9.3	Carbon dioxide, solid (dry ice) - ICE	10
3.2.2.9.4	Magnetic material - MAG.....	10
3.2.3	CLASS 2.1, 3 AND 4 POSITIONING ON BOARD	11
3.2.4	HANDLING LABELS AND MARKINGS	12

 Volume II HLM	INTRODUCTION	0.2	Page 3
	GENERAL INDEX	Ed 2 Rev 18/26 feb 26	

3.2.4.1	Label - Magnetized Material (MAG)	12
3.2.4.2	Label - Cargo Aircraft Only (CAO)	12
3.2.4.3	Label - Package orientation	12
3.2.4.4	Label - Cryogenic liquid (RCL)	13
3.2.4.5	Label - Radioactive Material Excepted Package (RRE)	13
3.2.4.6	Label - Keep away from Heat	13
3.2.4.7	Package marking - Lithium Batteries	14
3.2.4.8	Label - Battery powered Wheelchairs or Mobility	14
3.2.4.9	Package marking - Marking Excepted Quantities (REQ)	14
3.2.4.10	Package marking - Environmentally Hazardous Substance	15
3.2.4.11	Package marking - Limited quantity LTD QTY	15
3.2.4.12	Consumer labels not to be considered	15
3.2.5	RADIOACTIVE MATERIAL LOADING AND SEGREGATION	16
3.2.5.1	Radioactive Material Segregation and FIL	18
3.2.6	INCOMPATIBILITY BETWEEN DANGEROUS GOODS AND SPECIAL CARGO ...	19
3.2.7	DRY ICE	21
3.2.8	WHEELCHAIR OR MOBILITY AIDS HANDLING AND LOADING	22
3.2.8.1	Wheelchairs/Mobility Aids with spillable batteries	23
3.2.8.2	Wheelchairs / Mobility Aids with non-spillable wet batteries, nickel-metal hydride batteries or dry Batteries	24
3.2.8.3	Wheelchairs / Mobility Aids with Lithium Batteries	25
3.2.9	DANGEROUS GOODS DAMAGED OR LEAKING	26
3.2.9.1	Before loading	26
3.2.9.2	In cargo compartments	26
3.3	SPECIAL CARGO	1
3.3.1	LIVE ANIMAL (AVI)	1
3.3.1.1	Quantity of live animals allowed on board Company aircraft	2
3.3.1.2	Aircraft compartments suitability for transportation of live animals and maximum transportable loads	3
3.3.1.3	Maximum dimensions for AVI cages	4
3.3.2	HUMAN REMAINS (HUM)	5
3.3.2.1	Loading for aircraft type	5
3.3.3	OVERHANG (OHG)	6
3.3.4	EXTRA HEAVY/BIG LOADS (HEA/BIG)	6
3.3.4.1	Bulk/container load restraint	6
3.3.5	NO COMPRESSIBLE LOADS	7
3.3.6	PIERCING LOADS	7

 Volume II HLM	INTRODUCTION	0.2	Page 4
	GENERAL INDEX	Ed 2 Rev 18/26 feb 26	

3.3.7	CUTTING LOADS	7
3.3.8	PERISHABLE AND TEMPERATURE SENSITIVE HEALTHCARE	8
3.3.9	SEGREGATION BETWEEN ACT - COL - CRT - ERT	8
3.3.10	VALUABLES/WEAPONS (VAL/WEA)	9
3.4	NOTOC (SPECIAL LOAD NOTIFICATION TO CAPTAIN).....	1
3.4.1	MANDATORY NOTOC FOR SPECIAL CARGO SHIPMENT	2
3.4.2	NO MANDATORY NOTOC FOR DANGEROUS GOODS SHIPMENT	3
3.4.2.1	Example of EDP NOTOC	3
3.4.2.2	Example of Manual NOTOC	3
3.4.2.3	Manual NOTOC Filling Instruction	4
Cap. 4	WEIGHT AND BALANCE	
4.1	GENERAL	1
4.1.1	INTRODUCTION	1
4.1.2	PURPOSE AND SCOPE	1
4.1.3	FUNCTION AND RESPONSIBILITY	2
4.1.3.1	Load Control Function	3
4.1.3.1.1	Load planning	3
4.1.3.1.2	Loadsheet and Messages	4
4.1.3.2	Loading/Unloading Supervision Function	5
4.1.3.3	Aircraft Loading Function	6
4.2	LOAD PLANNING.....	1
4.2.1	ESTIMATED ZERO FUEL WEIGHT (EZFW) CALCULATION	1
4.2.1.1	Communication in case of EZFW variation	2
4.2.2	OPERATING CREW WEIGHT CALCULATION	3
4.2.3	OPERATING CREW BAGGAGE WEIGHT CALCULATION	4
4.2.4	PASSENGER WEIGHT CALCULATION	5
4.2.4.1	Non standard passengers on scheduled and charter flights	6
4.2.5	REGISTRED BAGGAGE WEIGHT PLANNING AND CALCULATION	7
4.2.6	ULD TARE CALCULATION	9
4.2.7	SPECIAL FLIGHT KIT WEIGHT CALCULATION (SFK)	10
4.2.8	OPTIMIZED CG (Centre of Gravity)	10
4.2.9	TIPPING PREVENTION	11
4.2.10	USE OF BALLAST	12
4.2.11	LIMITATIONS	13

 Volume II HLM	INTRODUCTION	0.2	Page 5
	GENERAL INDEX	Ed 2 Rev 18/26 feb 26	

4.2.11.1	Structural aircraft limitations	13
4.2.11.1.1	Point load limitation	13
4.2.11.1.2	Area load limitation	14
4.2.11.1.3	Linear (running) load limitation	15
4.2.11.1.4	Cumulative load limitation.....	15
4.2.11.2	Loading limitations	16
4.2.12	LOADING INSTRUCTION REPORT (LIR)	17
4.2.12.1	General	17
4.2.12.2	Form	19
4.2.12.3	Compilation and use	20
4.3	LOADSHEET	1
4.3.1	GENERAL INFORMATION	1
4.3.2	WEIGHTS DEFINITION AND CALCULATION	2
4.3.2.1	Weight Limits	2
4.3.2.2	Traffic load	3
4.3.2.3	Actual weight	4
4.3.2.4	Weight and balance conditions	6
4.3.3	FUEL FIGURES	7
4.3.3.1	Preamble	7
4.3.3.2	Fuel Definitions	7
4.3.3.3	“Just in Time Refuelling” procedure (JITR)	8
4.3.3.4	A330 non-standard fuel distribution	10
4.3.3.4.1	Load planning and anti tipping.....	10
4.3.3.4.2	Finalisation procedure for aircraft subject to NSFD	10
4.3.3.4.3	A330 - fuel curve graph per tank	11
4.3.3.4.4	A330 - fuel table per tank	12
4.3.3.4.5	A330 900 - fuel curve graph per tank	13
4.3.3.4.6	A330 900 - fuel table per tank	14
4.3.3.4.7	Example - A330 NON-STANDARD FUEL DISTRIBUTION FORM.....	15
4.3.3.4.8	A350 900 - fuel curve graph per tank	16
4.3.3.4.9	A350 900 - fuel table per tank	17
4.3.3.4.10	A350 NON-STANDARD FUEL DISTRIBUTION FORM	18
4.3.4	MANUAL LOADSHEET	19
4.3.4.1	Filling basic instructions	19
4.3.4.2	Manual Loadsheets elements identification	20
4.3.5	EDP LOADSHEET	30

 Volume II HLM	INTRODUCTION	0.2	Page 6
	GENERAL INDEX	Ed 2 Rev 18/26 feb 26	

4.3.5.1	EDP ACARS Loadsheet	30
4.3.5.2	EDP Loadsheet elements identification	32
4.3.6	REMOTE LOADSHEET ITA FLIGHTS	37
4.3.6.1	Introduction, mode and functions involved	37
4.3.6.1.1	Communication method.....	37
4.3.6.2	CLC procedure	39
4.3.6.2.1	Timing and activities	39
4.3.6.3	CLC LDS Procedure	41
4.3.6.3.1	Station CLC Coordinator function.....	42
4.3.6.3.2	Timing and activities	43
4.3.6.3.3	LDS - Example	44
4.3.6.3.4	LDS - Filling instructions.....	47
4.3.7	CODES TO BE USED ON LOADSHEET	49
4.3.8	FREE SEATING	55
4.3.9	FORCED PAX DISTRIBUTION	55
4.3.10	PASSENGER DISTRIBUTION ON MULTI LEG OR CIRCULAR FLIGHT	55
4.3.11	STRETCHER ON BOARD	56
4.3.12	LAST MINUTE CHANGES (LMC)	57
4.4	BALANCE CHART	1
4.4.1	GENERAL	1
4.4.2	FILLING	1
4.4.2.1	Balance Chart Example	3
4.5	FLIGHT DOCUMENTATION COLLECTION AND FILING	1
Cap. 5	INFORMATION PER AIRCRAFT TYPE	
5.1	A-350 - ITA.....	1
5.1.1	HOLDS	1

 Volume II HLM	INTRODUCTION	0.2	Page 7
	GENERAL INDEX	Ed 2 Rev 18/26 feb 26	

5.1.1.1	Cargo compartment specifications	1
5.1.1.2	Cargo compartment temperature and ventilation	12
5.1.1.3	Resistance of fittings	12
5.1.1.4	Forward hold (compartment 1-2) cargo door maximum dimensions	13
5.1.1.5	Aft hold (compartment 3-4) cargo door maximum dimensions	14
5.1.1.6	Bulk hold (compartment 5) cargo door maximum dimensions	15
5.1.1.7	Divider net between compartment 4 and 5	16
5.1.1.8	Maximum dimensions for conventional load in compartment 5	17
5.1.1.8.1	Upright loading	17
5.1.1.8.2	Upright and tilted loading.....	20
5.1.1.8.3	Crosswise loading	21
5.1.1.9	Cross section of compartments 1-2-3-4 - internal dimensions for the loading of conventional loads	23
5.1.2	FUEL	24
5.1.3	USE OF MARKER CONES	25
5.1.4	CHOCKING OF AIRCRAFT	25
5.1.5	CHOCKING OF AIRCRAFT WITH WIND OVER 25 kt (46.3 km/h)	26
5.1.6	SERVICING ARRANGEMENTS	27
5.1.7	TOILETTE DRAIN	28
5.1.7.1	Toilette drain servicing panel	29
5.1.8	FILLING POTABLE WATER	30
5.1.8.1	Potable water servicing panel	31
5.1.9	SAFETY AREAS	32
5.1.9.1	Idle thrust - Intake and Blast areas	32
5.1.10	Steering limits	33
5.2	A330-900 ITA	1
5.2.1	HOLDS	1

 Volume II HLM	INTRODUCTION	0.2	Page 8
	GENERAL INDEX	Ed 2 Rev 18/26 feb 26	

5.2.1.1	Cargo compartments specifications	1
5.2.1.2	Cargo compartment temperature and ventilation	8
5.2.1.3	Resistance of fittings	8
5.2.1.4	Forward hold (compartment 1-2) cargo door maximum dimensions	9
5.2.1.5	Aft hold (compartment 3-4) cargo door maximum dimensions	10
5.2.1.6	Bulk hold (compartment 5) cargo door maximum dimensions	11
5.2.1.7	Maximum dimensions for conventional load in compartment 5	12
5.2.1.7.1	B) Upright loading and tilted loading	13
5.2.1.8	Cross section of compartments 1-2-3-4 - internal dimensions for the loading of conventional loads	14
5.2.2	FUEL	15
5.2.3	USE OF MARKER CONES	17
5.2.4	CHOCKING OF AIRCRAFT	18
5.2.5	Chocking of aircraft with wind over 25kt (46.3 km/h)	19
5.2.6	SERVICING ARRANGMENTS	20
5.2.7	TOILETTE DRAIN	21
5.2.8	FILLING POTABLE WATER	23
5.2.9	SAFETY AREAS	25
5.2.9.1	Idle thrust - Intake and Blast areas	25
5.2.10	Steering limits	26
5.3	A330 202 - ITA	1
5.3.1	HOLDS	1
5.3.1.1	Cargo compartment specifications	1
5.3.1.2	Cargo compartment temperature and ventilation	8
5.3.1.3	Resistance of fittings	8
5.3.1.4	Forward hold (compartment 1-2) cargo door maximum dimensions	9
5.3.1.5	Aft hold (compartment 3-4) cargo door maximum dimensions	10
5.3.1.6	Bulk hold (compartment 5) cargo door maximum dimensions	11
5.3.1.7	Maximum dimensions for conventional load in compartment 5	11
5.3.1.7.1	A) Upright loading	12
5.3.1.7.2	B) Upright loading and tilted loading	13
5.3.1.8	Cross section of compartments 1-2-3-4 - internal dimensions for the loading of conventional loads	14
5.3.2	FUEL	15
5.3.3	USE OF MARKER CONES	16
5.3.4	CHOCKING OF AIRCRAFT	17
5.3.5	Chocking of aircraft with wind over 25kt (46.3 km/h)	18

 Volume II HLM	INTRODUCTION	0.2	Page 9
	GENERAL INDEX	Ed 2 Rev 18/26 feb 26	

5.3.6	SERVICING ARRANGMENTS	19
5.3.7	TOILETTE DRAIN	20
5.3.8	FILLING POTABLE WATER	21
5.3.9	SAFETY AREAS	23
5.3.9.1	Idle thrust - Intake and Blast areas	23
5.3.10	Steering limits	24
5.4	A321 neo - ITA.....	1
5.4.1	HOLDS	1
5.4.1.1	Cargo compartments specifications A321/neo	1
5.4.1.2	Cargo compartment temperature and ventilation	4
5.4.2	CLS malfunctions	5
5.4.2.1	Fwd and aft cargo doors dimensions	9
5.4.2.2	Loading through the cargo door of compartment 5	11
5.4.2.3	Loading through compartment 4	11
5.4.3	LOADING PROCEDURE FOR A321 NEO CONTAINERIZED A/C IN STATIONS WITHOUT SUITABLE LOADER	12
5.4.3.1	Cross section of compartments 1-2-3-4 - internal dimensions for the loading of conventional loads	13
5.4.4	Fuel	14
5.4.5	LOAD LIMITATIONS	16
5.4.5.1	Shear and bending moment limitations	16
5.4.6	USE OF MARKER CONES	17
5.4.7	CHOCKING OF AIRCRAFT	18
5.4.8	Chocking of aircraft with wind over 25kt (46.3 km/h)	18
5.4.9	SERVICING ARRANGEMENTS	19
5.4.10	TOILETTE DRAIN	20
5.4.11	FILLING POTABLE WATER	21
5.4.12	PRE DEPARTURE SERVICING CHECK LIST	24
5.4.13	SAFETY AREAS	25
5.4.13.1	Idle thrust - Intake and Blast areas	25
5.4.14	Steering limits	26
5.5	A320/200 - A320 neo - ITA.....	1
5.5.1	HOLDS	1
5.5.1.1	Cargo compartment specifications A320/200	1
5.5.2	CLS malfunctions	5

 Volume II HLM	INTRODUCTION	0.2	Page 10
	GENERAL INDEX	Ed 2 Rev 18/26 feb 26	

5.5.2.1	Intentionally left blank	8
5.5.2.2	Cargo compartment temperature and ventilation	9
5.5.2.3	Resistance of fittings	9
5.5.2.4	Forward and aft cargo door maximum dimensions	10
5.5.2.5	Maximum dimensions for conventional load in compartment 5	11
5.5.3	LOADING PROCEDURE FOR A320 CONTAINERIZED A/C IN STATIONS WITHOUT SUITABLE LOADER	12
5.5.3.1	Cross section of compartments 1-3-4 - internal dimensions for the loading of conventional loads	13
5.5.4	FUEL	14
5.5.5	LOAD LIMITATIONS	16
5.5.5.1	Shear and bending moment limitations	16
5.5.6	USE OF MARKER CONES	17
5.5.7	CHOCKING OF AIRCRAFT	17
5.5.8	Chocking of aircraft with wind over 25kt (46.3 km/h)	18
5.5.9	SERVICING ARRANGEMENTS	19
5.5.10	TOILETTE DRAIN	21
5.5.11	FILLING POTABLE WATER	22
5.5.12	PRE DEPARTURE SERVICING CHECK LIST	24
5.5.13	SAFETY AREAS	25
5.5.13.1	Idle thrust - Intake and Blast areas	25
5.5.14	Steering limits	26
5.6	A319 - ITA.....	1
5.6.1	HOLDS	1
5.6.1.1	Cargo compartment specifications	1
5.6.2	CLS malfunction	5
5.6.2.1	Cargo compartment temperature and ventilation	8
5.6.2.2	Resistance of fittings	8
5.6.2.3	Forward and aft cargo door maximum dimensions	9
5.6.2.4	Maximum dimensions for conventional load in compartment 5	10
5.6.3	LOADING PROCEDURE FOR A319 CONTAINERIZED A/C IN STATIONS WITHOUT SUITABLE LOADER	12
5.6.3.1	Cross section of compartments 1-4 - internal dimensions for the loading of conventional loads	13
5.6.4	FUEL	14
5.6.5	LOAD LIMITATIONS	15

 Volume II HLM	INTRODUCTION	0.2	Page 11
	GENERAL INDEX	Ed 2 Rev 18/26 feb 26	

5.6.5.1	Shear and bending moment limitations	15
5.6.6	USE OF MARKER CONES	16
5.6.7	CHOCKING OF AIRCRAFT	16
5.6.8	Chocking of aircraft with wind over 25kt (46.3 km/h)	17
5.6.9	SERVICING ARRANGEMENTS	18
5.6.10	TOILETTE DRAIN	19
5.6.11	FILLING POTABLE WATER	20
5.6.12	PRE DEPARTURE SERVICING CHECK LIST	22
5.6.13	SAFETY AREAS	23
5.6.13.1	Idle thrust - Intake and Blast areas	23
5.6.14	Steering limits	24
5.7	A220 300 - ITA	1
5.7.1	HOLDS	1
5.7.1.1	Cargo compartment specifications	1
5.7.1.2	Holds temperature and ventilation	8
5.7.1.3	Live Animals (AVI)	9
5.7.1.4	Human Remains (HUM)	9
5.7.1.5	Forward cargo door dimensions	10
5.7.1.6	Aft cargo door dimensions	12
5.7.2	Cargo doors opening	15
5.7.3	FUEL	16
5.7.4	USE OF MARKER CONES	17
5.7.5	CHOCKING OF AIRCRAFT	17
5.7.6	Chocking of aircraft with wind over 25kt (46.3 km/h)	18
5.7.7	TOILETTE DRAIN	19
5.7.8	FILLING POTABLE WATER	20
5.7.9	BULK HOLDS LOADING/UNLOADING ASSISTANCE	21
5.7.10	PRE DEPARTURE SERVICING CHECK LIST	22
5.7.11	SAFETY AREAS	23
5.7.11.1	Idle thrust - Intake and Blast Areas	23
5.7.12	SERVICING ARRANGEMENTS	24
5.7.13	Steering limits	25
5.8	A220 100 - ITA	1
5.8.1	HOLDS	1

 Volume II HLM	INTRODUCTION	0.2	Page 12
	GENERAL INDEX	Ed 2 Rev 18/26 feb 26	

5.8.1.1	Cargo compartment specifications	1
5.8.1.2	Holds temperature and ventilation	8
5.8.1.3	Live Animals (AVI)	9
5.8.1.4	Human Remains (HUM)	9
5.8.1.5	Cargo doors dimensions	10
5.8.2	Cargo doors opening	14
5.8.3	FUEL	15
5.8.4	USE OF MARKER CONES	16
5.8.5	CHOCKING OF AIRCRAFT	16
5.8.6	Chocking of aircraft with wind over 25kt (46.3 km/h)	17
5.8.7	TOILETTE DRAIN	18
5.8.8	FILLING POTABLE WATER	19
5.8.9	BULK HOLDS LOADING/UNLOADING ASSISTANCE	20
5.8.10	PRE DEPARTURE SERVICING CHECK LIST	21
5.8.11	SAFETY AREAS	22
5.8.11.1	Idle thrust - Intake and Blast Areas	22
5.8.12	SERVICING ARRANGEMENTS	23
5.8.13	Steering limits	24
Cap. 6	UNIT LOAD DEVICE	
	(ULD)	
6.1	GENERAL CHARACTERISTICS.....	1
6.1.1	INTRODUCTION	1
6.1.2	ID - CODE	1
6.1.3	TECHNICAL INFORMATION	2

 Volume II HLM	INTRODUCTION	0.2	Page 13
	GENERAL INDEX	Ed 2 Rev 18/26 feb 26	

6.1.3.1	AKE Container (made of composite material)	2
6.1.3.2	AKH & AKH light weight container	3
6.1.3.3	PAG - P1P Pallet	4
6.1.3.4	PMC - P6P - PMA Pallet	5
6.1.3.5	PKC Pallet	6
6.1.3.6	PLA Pallet	7
6.1.3.7	AAP Container	8
6.1.3.8	AMP Container	9
6.1.3.9	Nets	10
6.1.3.9.1	Pallet permanent fixed net.....	11
6.1.3.10	Straps	11
6.1.3.11	Tracking devices	11
6.1.3.12	Skycell and Va-Q-Tec Containers on uld	11
6.1.4	Containers for special cargo transportation	13
6.2	MANAGEMENT	1
6.2.1	PREAMBLE	1
6.2.2	ALLOTMENT	1
6.2.3	OPERATIVE MANAGEMENT	1
6.2.3.1	General rules	1
6.2.3.2	PKC pallets request	2
6.2.3.3	AKH containers request	2
6.2.3.4	Weekly inventory	3
6.2.4	ULD Damages	3
6.2.4.0.1	Unserviceable nets	9
6.2.4.1	Reception / Transfer	10
6.2.4.2	Maintenance	10
6.3	HANDLING	1
6.3.1	STORAGE	1
6.3.1.1	Unserviceable ULDs storage	1
6.3.2	MOVEMENT	1
Cap. 7	AIRCRAFT GROUND MOVEMENT	
7.1	GENERAL INFORMATION.....	1
7.1.1	SCOPE	1
7.1.2	GROUND STAFF RESPONSIBILITIES AND ROLES	1
7.1.3	MOVEMENT DEFINITIONS	2

 Volume II HLM	INTRODUCTION	0.2	Page 14
	GENERAL INDEX	Ed 2 Rev 18/26 feb 26	

7.1.4	GSE DEFINITIONS AND UTILIZE	2
7.1.5	WALK-AROUND CHECK	2
7.1.5.1	Walk-Around Check Items	3
7.1.5.2	Walk-Around Check Form	4
7.2	AIRCRAFT ARRIVAL	1
7.2.1	ACTIONS PRIOR TO AIRCRAFT ARRIVAL	1
7.2.2	ARRIVAL PROCEDURE	2
7.2.3	AIRCRAFT ARRIVAL AT THE STAND WITH HOT BRAKES (SMOKING OR ON FIRE) 3	
7.3	AIRCRAFT DEPARTURE	1
7.3.1	PUSHBACK OPERATION REQUIREMENTS	1
7.3.2	COMMUNICATION DURING DEPARTURE OPERATIONS	2
7.3.2.1	Restoring interphone communication at the end of operation	3
7.3.3	ANTI-COLLISION LIGHTS	3
7.3.4	ENGINE START	4
7.3.5	TAXI-OUT DEPARTURE (SELF MANOEUVRING)	4
7.3.5.1	Standard phraseology: self-manoeuving departure communication	4
7.3.5.2	Engine star up by Air Start Unit (ASU) and/or Ground Power Unit (GPU)	5
7.3.5.2.1	Communication during engine start up by ASU and/or GPU	5
7.3.6	NO VISIBILITY AREA FROM COCKPIT	6
7.3.7	PUSHBACK	7
7.3.7.1	Actions to perform before starting the manoeuvre	8
7.3.7.2	Manoeuvre	10
7.3.7.3	Subsequent operations to pushback and engine start up	11
7.3.7.4	One Man Operator - OMO	12
7.3.7.5	Manoeuvring in severe weather and surface condition	12
7.3.7.6	Satandard phraseology: communication with pushback manoeuvre	13
7.3.7.7	Emergencies during engine start up	14
7.3.7.7.1	Communication during Engine Fire	14
7.3.7.7.2	Engine fire	15
7.3.7.7.3	Tailpipe fire	15
7.3.7.8	Instruction in case of pushback incidents	15
7.3.7.8.1	General incident	15
7.3.8	TOWING	16

 Volume II HLM	INTRODUCTION	0.2	Page 15
	GENERAL INDEX	Ed 2 Rev 18/26 feb 26	

7.3.8.1	Manoeuvre	17
7.3.8.2	Towing limits	17
7.3.8.3	Starting towing - check list	18
7.3.8.4	End of towing - check list	19
7.3.8.5	Procedure for incident during Towing	20
7.4	HAND SIGNALS	1
7.4.1	INTRODUCTION	1
7.4.1.1	Conditions for using hand signals	1
7.4.2	GUIDE MAN HAND SIGNALS (FOR GSE)	1
7.4.3	OTHER OPERATIONS HAND SIGNALS	7
7.4.3.1	Marshalling (Taxi-in and Taxi-out) hand signals	7
7.4.3.2	Technical/servicing hand signals - Ground Staff to Flight Deck	12
7.4.3.3	Technical/servicing hand signals - Flight Deck to Ground Staff	15
7.4.3.4	Pushback (TT-TBL-MGT) / Towing (TT-TBL) hand signals - Headset Operator to Tug Driver	16
7.4.3.5	Wing Walker hand signals - to Headset Operator and/or Tug Driver	18
Cap. 8	RAMP HANDLING	
8.1	GENERAL	1
8.1.1	WORK SAFETY PREACUTION	1
8.2	NO TRANSIT CHECK.....	1
8.2.1	INTRODUCTION	1
8.2.2	GROUND STAFF DUTIES	2
8.2.2.1	Documents collection	2
8.3	GROUND OPERATIONS SUPERVISION AND SAFETY	1
8.3.1	EQUIPMENT RESTRAINT AREA & EQUIPMENT RESTRAINT LINE	1
8.3.2	AIRCRAFT CHOCKING	2
8.3.2.1	Chocks placement and removal	2
8.3.3	SAFETY CONES	4
8.3.3.1	Marker cones placement and removal	4
8.3.4	DANGER AREAS	4
8.3.4.1	Engines Intake/Blast areas	4
8.3.5	FOD - FOREIGN OBJECT DEBRIS	5
8.3.5.1	FOD checks	5
8.3.6	ADVERSE WEATHER CONDITIONS	6

 Volume II HLM	INTRODUCTION	0.2	Page 16
	GENERAL INDEX	Ed 2 Rev 18/26 feb 26	

8.3.6.1	Winter or slippery apron conditions	6
8.3.6.2	Thunderstorms	6
8.3.6.3	High wind conditions	7
8.3.6.3.1	High winds activity matrix	7
8.3.7	AIRSIDE FIRE SAFETY	8
8.3.7.1	Identification and elimination of condition that could lead to a fire	8
8.3.7.2	Availability, access and use of fire-fighting equipment	8
8.3.7.3	Emergency procedure and alerting personnel on board the aircraft	9
8.3.7.3.1	In case of fire alarm	9
8.3.7.3.2	In case of fire	9
8.3.7.4	Controlling and reporting fires	10
8.3.8	SPILLAGE	10
8.3.8.1	Non-hazardous	10
8.3.8.2	Hazardous	10
8.3.9	PASSENGER SAFETY	10
8.3.10	SUPERVISION	11
8.4	GENERAL INSTRUCTIONS FOR USE OF GSE	1
8.4.1	SAFETY INSTRUCTIONS FOR USE OF GSE	1
8.4.1.1	GSE maintenance	1
8.4.2	BASIC OPERATING REQUIREMENTS FOR GSE	1
8.4.3	GSE/VEHICLES SAFETY DRIVING AND PARKING INSIDE ERA	3
8.4.4	PASSENGER BOARDING EQUIPMENT	4
8.4.4.1	General	4
8.4.4.2	Loading Bridge	5
8.4.4.3	Passenger stairs	6
8.4.5	GROUND POWER UNIT (GPU)	7
8.4.6	AIR STARTER UNIT (ASU)	9
8.4.7	COOLING / HEATING UNITS PRE CONDITIONED AIR (ACU)	10
8.4.8	FILLING POTABLE WATER	11
8.4.8.1	Introduction	11
8.4.8.2	General rules	11
8.4.8.3	Hygienic precaution	11
8.4.8.4	Water disinfection	12
8.4.8.5	Water analysis	12
8.4.9	TOILETTE DRAIN	13

 Volume II HLM	INTRODUCTION	0.2	Page 17
	GENERAL INDEX	Ed 2 Rev 18/26 feb 26	

8.4.9.1	Introduction	13
8.4.9.2	General Rules	13
8.4.9.3	Hygienic Precaution	13
8.4.9.4	Servicing in extreme cold weather conditions	13
8.4.10	AIRCRAFT LOADING EQUIPMENT	14
8.4.10.1	Belt loader	14
8.4.10.2	Loader (ULD)	16
8.4.10.3	Transloader	17
8.4.10.4	Fork-lift to slave pallet	17
8.4.10.5	Transporter	18
8.4.10.6	Rolling stock (carts / dollies)	18
8.4.10.7	Tractors	18
8.5	DOORS OPENING/CLOSING (ALL AIRCRAFT TYPES)	1
8.5.1	GENERAL	1
8.5.2	CABIN AIRCRAFT DOORS	1
8.5.2.1	Door opening with crew on board	2
8.5.2.2	Door closing with crew on board	2
8.5.2.3	Door re-opening with crew on board	3
8.5.2.4	Door opening from the outside without flight crew on board	3
8.5.2.5	Door closing without crew on board	3
8.5.3	CARGO AIRCRAFT DOORS	4
8.5.3.1	Cargo door opening	4
8.5.3.2	Cargo doors closing	4
8.6	REFUELLING	1
8.6.1	GENERAL INFORMATION	1
8.6.2	AIRCRAFT PROTECTION AND SAFETY RECOMMENDATIONS DURING FUELING / DEFUELING OPERATIONS	2
8.6.2.1	Fuelling Safety Zone	2
8.6.3	FUELLING / DEFUELLING WITH PASSENGERS ON BOARD, EMBARKING OR DISEMBARKING	4
8.6.3.1	Duties of Station Manager	4
8.6.3.2	Duties of Ground Staff	5
8.6.4	NO TRANSIT CHECK - GROUND STAFF ACTIVITIES	6
8.6.4.1	Fuel panel selection	7
8.6.4.2	Fuel quality control check	7
8.6.5	EMERGENCY DURING FUELING / DEFUELING	8

 Volume II HLM	INTRODUCTION	0.2	Page 18
	GENERAL INDEX	Ed 2 Rev 18/26 feb 26	

8.6.5.1	Fuel vapours/fire detected inside the aircraft	8
8.6.5.2	Fuel spillage	8
8.6.5.3	Fire on Ramp during refuelling	9
8.7	SURFACE TRANSPORTATION AND TRANSFER.....	1
8.7.1	INTRODUCTION	1
8.7.2	TRANSPORT FROM FACILITY TO AIRCRAFT	1
8.7.3	TRANSPORT FROM AN AIRCRAFT TO OTHER AIRPORT AREA/TO OTHER AIRCRAFT	1

Cap. 9 LOADING AND TIE DOWN

9.1	LOADING / UNLOADING	1
9.1.1	SAFETY REQUIREMENTS SPECIFIC TO AIRCRAFT LOADING / UNLOADING OPERATIONS	1
9.1.2	IDENTIFYING SHIPMENTS REQUIRING SPECIFIC HANDLING	3
9.1.3	CARGO HOLD INSPECTION	3
9.1.4	COMPARTMENT SEPARATOR NETS AND CARGO DOOR BARRIER NET	4
9.1.5	CONTAINER/PALLET RESTRAINT SYSTEM	4
9.1.6	SCALING PROCESS	4
9.1.7	LEAKAGE INSPECTION BEFORE LOADING	4
9.1.8	LEAKAGE IN CARGO COMPARTMENTS	4
9.1.9	LOW WING AIRCRAFT	5
9.1.10	TIPPING PREVENTION	5
9.1.11	BLOW-OUT PANELS	5
9.2	BAGGAGE ASSISTANCE	1
9.2.1	BAGGAGE RICONCILIATION	1
9.2.2	DISTRIBUTION CRITERIA	2
9.2.2.1	Flights to FCO & LIN	2
9.2.2.2	Flights with different destinations from FCO and LIN	3
9.2.3	ULD TAG	3
9.2.4	AUTOMATIC ULD TAG (example)	4
9.2.5	LOADING SEQUENCE	8
9.2.6	LOADING INFORMATION CODES	8
9.2.7	CODES FOR AVAILABLE CAPACITY OF ULD	9
9.2.8	CREW BAGS	9
9.3	LOAD RESTRAINT	1
9.3.1	GENERAL	1
9.3.2	TIE DOWN EQUIPMENT	3

 Volume II HLM	INTRODUCTION	0.2	Page 19
	GENERAL INDEX	Ed 2 Rev 18/26 feb 26	

9.3.3 LOAD RESTRAINT FACTORS5

 Volume II HLM	INTRODUCTION	0.3	Page 1
	LIST OF EFFECTIVE PAGES	Ed 2 Rev 18/26 feb 26	

0.3 LIST OF EFFECTIVE PAGES

Part / Chapter	Pag.	Issue Date
0.1		
	1	Ed 2/20 apr 2022
0.2		
	1	Ed 2 Rev 18/26 feb 26
	2	Ed 2 Rev 18/26 feb 26
	3	Ed 2 Rev 18/26 feb 26
	4	Ed 2 Rev 18/26 feb 26
	5	Ed 2 Rev 18/26 feb 26
	6	Ed 2 Rev 18/26 feb 26
	7	Ed 2 Rev 18/26 feb 26
	8	Ed 2 Rev 18/26 feb 26
	9	Ed 2 Rev 18/26 feb 26
	10	Ed 2 Rev 18/26 feb 26
	11	Ed 2 Rev 18/26 feb 26
	12	Ed 2 Rev 18/26 feb 26
	13	Ed 2 Rev 18/26 feb 26
	14	Ed 2 Rev 18/26 feb 26
	15	Ed 2 Rev 18/26 feb 26
	16	Ed 2 Rev 18/26 feb 26
	17	Ed 2 Rev 18/26 feb 26
	18	Ed 2 Rev 18/26 feb 26
	19	Ed 2 Rev 18/26 feb 26
0.3		
	1	Ed 2 Rev 18/26 feb 26
	2	Ed 2 Rev 18/26 feb 26
	3	Ed 2 Rev 18/26 feb 26
	4	Ed 2 Rev 18/26 feb 26
	5	Ed 2 Rev 18/26 feb 26
	6	Ed 2 Rev 18/26 feb 26
	7	Ed 2 Rev 18/26 feb 26
	8	Ed 2 Rev 18/26 feb 26
0.4		
	1	Ed 2 Rev 18/26 feb 26
	2	Ed 2 Rev 18/26 feb 26
Chapt. 1		
1.1		
	1	Ed 2/20 apr 2022
Chapt. 2		
2.1		
	1	Ed 2/20 apr 2022
2.2		
	1	Ed 2/20 apr 2022
2.3		
	1	Ed 2/20 apr 2022

Part / Chapter	Pag.	Issue Date
2.4		
	1	Ed 2/20 apr 2022
2.5		
	1	Ed 2/20 apr 2022
	2	Ed 2/20 apr 2022
	3	Ed 2/20 apr 2022
Chapt. 3		
3.1		
	1	Ed 2/20 apr 2022
3.2		
	2	Ed 2/20 apr 2022
	3	Ed 2/20 apr 2022
	4	Ed 2/20 apr 2022
	5	Ed 2/20 apr 2022
	6	Ed 2/20 apr 2022
	7	Ed 2/20 apr 2022
	8	Ed 2/20 apr 2022
	9	Ed 2 Rev 1/15 oct 2022
	10	Ed 2 Rev 3/26 may 23
	11	Ed 2 Rev 17/27 jan 26
	12	Ed 2/20 apr 2022
	13	Ed 2/20 apr 2022
	14	Ed 2/20 apr 2022
	15	Ed 2/20 apr 2022
	16	Ed 2 Rev 1/15 oct 2022
	17	Ed 2 Rev 17/27 jan 26
	18	Ed 2/20 apr 2022
	19	Ed 2 Rev 17/27 jan 26
	20	Ed 2 Rev 17/27 jan 26
	21	Ed 2 Rev 17/27 jan 26
	22	Ed 2 Rev 17/27 jan 26
	23	Ed 2 Rev 17/27 jan 26
	24	Ed 2 Rev 17/27 jan 26
	25	Ed 2 Rev 17/27 jan 26
	26	Ed 2 Rev 17/27 jan 26
	27	Ed 2 Rev 17/27 jan 26
3.3		
	1	Ed 2 Rev 15/07 aug 25
	2	Ed 2 Rev 12/28 feb 25
	3	Ed 2 Rev 15/07 aug 25
	4	Ed 2 Rev 12/28 feb 25
	5	Ed 2 Rev 15/07 aug 25
	6	Ed 2/20 apr 2022
	7	Ed 2 Rev 14/05 jun 25

 Volume II HLM	INTRODUCTION	0.3	Page 2
	LIST OF EFFECTIVE PAGES	Ed 2 Rev 18/26 feb 26	

Part / Chapter	Pag.	Issue Date
	8	Ed 2/20 apr 2022
3.4		
	1	Ed 2 Rev 17/27 jan 26
	2	Ed 2 Rev 17/27 jan 26
	3	Ed 2 Rev 1/15 oct 2022
	4	Ed 2/20 apr 2022
	5	Ed 2/20 apr 2022
Chapt. 4		
4.1		
	1	Ed 2/20 apr 2022
	2	Ed 2/20 apr 2022
	3	Ed 2 Rev 16/04 sep 25
	4	Ed 2 Rev 2/26 jan 23
	5	Ed 2 Rev 17/27 jan 26
	6	Ed 2 Rev 17/27 jan 26
4.2		
	1	Ed 2/20 apr 2022
	2	Ed 2 Rev 6/15 nov 2023
	3	Ed 2/20 apr 2022
	4	Ed 2 Rev 3/26 may 23
	5	Ed 2 Rev 10/30 oct 24
	6	Ed 2 Rev 17/27 jan 26
	7	Ed 2/20 apr 2022
	8	Ed 2/20 apr 2022
	9	Ed 2 Rev 17/27 jan 26
	10	Ed 2 Rev 17/27 jan 26
	11	Ed 2 Rev 15/07 aug 25
	12	Ed 2 Rev 15/07 aug 25
	13	Ed 2/20 apr 2022
	14	Ed 2/20 apr 2022
	15	Ed 2/20 apr 2022
	16	Ed 2/20 apr 2022
	17	Ed 2/20 apr 2022
	18	Ed 2/20 apr 2022
	19	Ed 2/20 apr 2022
	20	Ed 2/20 apr 2022
	21	Ed 2/20 apr 2022
	22	Ed 2/20 apr 2022
	23	Ed 2 Rev 3/26 may 23
	24	Ed 2 Rev 3/26 may 23
4.3		
	1	Ed 2/20 apr 2022
	2	Ed 2/20 apr 2022
	3	Ed 2/20 apr 2022

Part / Chapter	Pag.	Issue Date
	4	Ed 2/20 apr 2022
	5	Ed 2/20 apr 2022
	6	Ed 2/20 apr 2022
	7	Ed 2/20 apr 2022
	8	Ed 2/20 apr 2022
	9	Ed 2/20 apr 2022
	10	Ed 2 Rev 9/14 jun 24
	11	Ed 2 Rev 5/02 nov 23
	12	Ed 2 Rev 5/02 nov 23
	13	Ed 2/20 apr 2022
	14	Ed 2/20 apr 2022
	15	Ed 2 Rev 8/15 mar 24
	16	Ed 2 Rev 5/02 nov 23
	17	Ed 2 Rev 5/02 nov 23
	18	Ed 2 Rev 8/15 mar 24
	19	Ed 2/20 apr 2022
	20	Ed 1/22 sep 2021
	21	Ed 2/20 apr 2022
	22	Ed 2/20 apr 2022
	23	Ed 2/20 apr 2022
	24	Ed 2/20 apr 2022
	25	Ed 2/20 apr 2022
	26	Ed 2/20 apr 2022
	27	Ed 2/20 apr 2022
	28	Ed 2/20 apr 2022
	29	Ed 2/20 apr 2022
	30	Ed 2/20 apr 2022
	31	Ed 2/20 apr 2022
	32	Ed 2/20 apr 2022
	33	Ed 2/20 apr 2022
	34	Ed 2/20 apr 2022
	35	Ed 2/20 apr 2022
	36	Ed 2 Rev 1/15 oct 2022
	37	Ed 2 Rev 17/27 jan 26
	38	Ed 2 Rev 17/27 jan 26
	39	Ed 2 Rev 17/27 jan 26
	40	Ed 2 Rev 17/27 jan 26
	41	Ed 2 Rev 17/27 jan 26
	42	Ed 2 Rev 17/27 jan 26
	43	Ed 2 Rev 17/27 jan 26
	44	Ed 2 Rev 17/27 jan 26
	45	Ed 2 Rev 17/27 jan 26
	46	Ed 2 Rev 17/27 jan 26
	47	Ed 2 Rev 17/27 jan 26

 Volume II HLM	INTRODUCTION	0.3	Page 3
	LIST OF EFFECTIVE PAGES	Ed 2 Rev 18/26 feb 26	

Part / Chapter	Pag.	Issue Date
	48	Ed 2 Rev 17/27 jan 26
	49	Ed 2 Rev 17/27 jan 26
	50	Ed 2 Rev 17/27 jan 26
	51	Ed 2 Rev 17/27 jan 26
	52	Ed 2 Rev 17/27 jan 26
	53	Ed 2 Rev 17/27 jan 26
	54	Ed 2 Rev 17/27 jan 26
	55	Ed 2 Rev 17/27 jan 26
	56	Ed 2 Rev 17/27 jan 26
	57	Ed 2 Rev 17/27 jan 26
4.4		
	1	Ed 2/20 apr 2022
	2	Ed 2/20 apr 2022
	3	Ed 2 Rev 3/26 may 23
	4	Ed 2 Rev 3/26 may 23
4.5		
	1	Ed 2 Rev 15/07 aug 25
Chapt. 5		
5.1		
	1	Ed 2/20 apr 2022
	2	Ed 2/20 apr 2022
	3	Ed 2 Rev 17/27 jan 26
	4	Ed 2 Rev 17/27 jan 26
	5	Ed 2 Rev 17/27 jan 26
	6	Ed 2 Rev 9/14 jun 24
	7	Ed 2 Rev 1/15 oct 2022
	8	Ed 2 Rev 9/14 jun 24
	9	Ed 2 Rev 1/15 oct 2022
	10	Ed 2 Rev 1/15 oct 2022
	11	Ed 2 Rev 17/27 jan 26
	12	Ed 2/20 apr 2022
	13	Ed 2/20 apr 2022
	14	Ed 2/20 apr 2022
	15	Ed 2/20 apr 2022
	16	Ed 2/20 apr 2022
	17	Ed 2/20 apr 2022
	18	Ed 2/20 apr 2022
	19	Ed 2/20 apr 2022
	20	Ed 2/20 apr 2022
	21	Ed 2/20 apr 2022
	22	Ed 2/20 apr 2022
	23	Ed 2/20 apr 2022
	24	Ed 2/20 apr 2022
	25	Ed 2/20 apr 2022

Part / Chapter	Pag.	Issue Date
	26	Ed 2/20 apr 2022
	27	Ed 2/20 apr 2022
	28	Ed 2/20 apr 2022
	29	Ed 2/20 apr 2022
	30	Ed 2/20 apr 2022
	31	Ed 2/20 apr 2022
	32	Ed 2/20 apr 2022
	33	Ed 2 Rev 9/14 jun 24
	34	Ed 2 Rev 9/14 jun 24
5.2		
	1	Ed 2 Rev 14/05 jun 25
	2	Ed 2 Rev 3/26 may 23
	3	Ed 2 Rev 13/28 mar 25
	4	Ed 2 Rev 3/26 may 23
	5	Ed 2 Rev 5/02 nov 23
	6	Ed 2 Rev 3/26 may 23
	7	Ed 2 Rev 17/27 jan 26
	8	Ed 2 Rev 3/26 may 23
	9	Ed 2 Rev 3/26 may 23
	10	Ed 2 Rev 3/26 may 23
	11	Ed 2 Rev 3/26 may 23
	12	Ed 2 Rev 3/26 may 23
	13	Ed 2 Rev 3/26 may 23
	14	Ed 2 Rev 3/26 may 23
	15	Ed 2 Rev 3/26 may 23
	16	Ed 2 Rev 5/02 nov 23
	17	Ed 2 Rev 3/26 may 23
	18	Ed 2 Rev 3/26 may 23
	19	Ed 2 Rev 3/26 may 23
	20	Ed 2 Rev 3/26 may 23
	21	Ed 2 Rev 3/26 may 23
	22	Ed 2 Rev 3/26 may 23
	23	Ed 2 Rev 3/26 may 23
	24	Ed 2 Rev 3/26 may 23
	25	Ed 2 Rev 3/26 may 23
	26	Ed 2 Rev 9/14 jun 24
	27	Ed 2 Rev 9/14 jun 24
5.3		
	1	Ed 2/20 apr 2022
	2	Ed 2/20 apr 2022
	3	Ed 2/20 apr 2022
	4	Ed 2/20 apr 2022
	5	Ed 2/20 apr 2022
	6	Ed 2/20 apr 2022

Part / Chapter	Pag.	Issue Date
	7	Ed 2 Rev 17/27 jan 26
	8	Ed 2 Rev 5/02 nov 23
	9	Ed 2/20 apr 2022
	10	Ed 2/20 apr 2022
	11	Ed 2/20 apr 2022
	12	Ed 2/20 apr 2022
	13	Ed 2/20 apr 2022
	14	Ed 2/20 apr 2022
	15	Ed 2/20 apr 2022
	16	Ed 2/20 apr 2022
	17	Ed 2/20 apr 2022
	18	Ed 2/20 apr 2022
	19	Ed 2/20 apr 2022
	20	Ed 2/20 apr 2022
	21	Ed 2/20 apr 2022
	22	Ed 2/20 apr 2022
	23	Ed 2/20 apr 2022
	24	Ed 2 Rev 9/14 jun 24
	25	Ed 2 Rev 9/14 jun 24
5.4		
	1	Ed 2 Rev 15/07 aug 25
	2	Ed 2 Rev 6/15 nov 23
	3	Ed 2 Rev 15/07 aug 25
	4	Ed 2 Rev 17/27 jan 26
	5	Ed 2 Rev 6/15 nov 23
	6	Ed 2 Rev 6/15 nov 23
	7	Ed 2 Rev 6/15 nov 23
	8	Ed 2 Rev 6/15 nov 23
	9	Ed 2 Rev 6/15 nov 23
	10	Ed 2 Rev 6/15 nov 23
	11	Ed 2 Rev 15/07 aug 25
	12	Ed 2 Rev 15/07 aug 25
	13	Ed 2 Rev 14/05 jun 25
	14	Ed 2 Rev 6/15 nov 23
	15	Ed 2 Rev 6/15 nov 23
	16	Ed 2 Rev 6/15 nov 23
	17	Ed 2 Rev 6/15 nov 23
	18	Ed 2 Rev 6/15 nov 23
	19	Ed 2 Rev 6/15 nov 23
	20	Ed 2 Rev 6/15 nov 23
	21	Ed 2 Rev 7/04 jan 24
	22	Ed 2 Rev 6/15 nov 23
	23	Ed 2 Rev 6/15 nov 23
	24	Ed 2 Rev 6/15 nov 23

Part / Chapter	Pag.	Issue Date
	25	Ed 2 Rev 6/15 nov 23
	26	Ed 2 Rev 9/14 jun 24
	27	Ed 2 Rev 9/14 jun 24
5.5		
	1	Ed 2 Rev 2/26 jan 23
	2	Ed 2 Rev 3/26 may 23
	3	Ed 2 Rev 2/26 jan 23
	4	Ed 2 Rev 17/27 jan 26
	5	Ed 2 Rev 2/26 jan 23
	6	Ed 2 Rev 2/26 jan 23
	7	Ed 2 Rev 2/26 jan 23
	8	Ed 2 Rev 9/14 jun 24
	9	Ed 2 Rev 2/26 jan 23
	10	Ed 2 Rev 2/26 jan 23
	11	Ed 2 Rev 2/26 jan 23
	12	Ed 2 Rev 2/26 jan 23
	13	Ed 2 Rev 14/05 jun 25
	14	Ed 2 Rev 2/26 jan 23
	15	Ed 2 Rev 2/26 jan 23
	16	Ed 2 Rev 2/26 jan 23
	17	Ed 2 Rev 2/26 jan 23
	18	Ed 2 Rev 2/26 jan 23
	19	Ed 2 Rev 2/26 jan 23
	20	Ed 2 Rev 2/26 jan 23
	21	Ed 2 Rev 2/26 jan 23
	22	Ed 2 Rev 2/26 jan 23
	23	Ed 2 Rev 2/26 jan 23
	24	Ed 2 Rev 2/26 jan 23
	25	Ed 2 Rev 2/26 jan 23
	26	Ed 2 Rev 9/14 jun 24
	27	Ed 2 Rev 9/14 jun 24
5.6		
	1	Ed 2/20 apr 2022
	2	Ed 2/20 apr 2022
	3	Ed 2/20 apr 2022
	4	Ed 2 Rev 17/27 jan 26
	5	Ed 2 Rev 2/26 jan 23
	6	Ed 2 Rev 2/26 jan 23
	7	Ed 2 Rev 2/26 jan 23
	8	Ed 2/20 apr 2022
	9	Ed 2/20 apr 2022
	10	Ed 2/20 apr 2022
	11	Ed 2/20 apr 2022
	12	Ed 2/20 apr 2022

 Volume II HLM	INTRODUCTION	0.3	Page 5
	LIST OF EFFECTIVE PAGES	Ed 2 Rev 18/26 feb 26	

Part / Chapter	Pag.	Issue Date
	13	Ed 2 Rev 14/05 jun 25
	14	Ed 2 Rev 2/26 jan 23
	15	Ed 2 Rev 2/26 jan 23
	16	Ed 2/20 apr 2022
	17	Ed 2/20 apr 2022
	18	Ed 2/20 apr 2022
	20	Ed 2/20 apr 2022
	21	Ed 2/20 apr 2022
	22	Ed 2/20 apr 2022
	23	Ed 2/20 apr 2022
	24	Ed 2 Rev 9/14 jun 24
	25	Ed 2 Rev 9/14 jun 24
5.7		
	1	Ed 2 Rev 5/02 nov 23
	2	Ed 2 Rev 5/02 nov 23
	3	Ed 2 Rev 1/15 oct 2022
	4	Ed 2 Rev 1/15 oct 2022
	5	Ed 2 Rev 1/15 oct 2022
	6	Ed 2 Rev 1/15 oct 2022
	7	Ed 2 Rev 1/15 oct 2022
	8	Ed 2 Rev 17/27 jan 26
	9	Ed 2 Rev 15/07 aug 25
	10	Ed 2 Rev 1/15 oct 2022
	11	Ed 2 Rev 1/15 oct 2022
	12	Ed 2 Rev 1/15 oct 2022
	13	Ed 2 Rev 1/15 oct 2022
	14	Ed 2 Rev 1/15 oct 2022
	15	Ed 2 Rev 1/15 oct 2022
	16	Ed 2 Rev 1/15 oct 2022
	17	Ed 2 Rev 1/15 oct 2022
	18	Ed 2 Rev 1/15 oct 2022
	19	Ed 2 Rev 1/15 oct 2022
	20	Ed 2 Rev 1/15 oct 2022
	21	Ed 2 Rev 1/15 oct 2022
	22	Ed 2 Rev 1/15 oct 2022
	23	Ed 2 Rev 1/15 oct 2022
	24	Ed 2 Rev 1/15 oct 2022
	25	Ed 2 Rev 8/15 mar 24
	26	Ed 2 Rev 8/15 mar 24
5.8		
	1	Ed 2 Rev 5/02 nov 23
	2	Ed 2 Rev 5/02 nov 23
	3	Ed 2 Rev 5/02 nov 23
	4	Ed 2 Rev 5/02 nov 23

Part / Chapter	Pag.	Issue Date
	5	Ed 2 Rev 5/02 nov 23
	6	Ed 2 Rev 5/02 nov 23
	7	Ed 2 Rev 5/02 nov 23
	8	Ed 2 Rev 17/27 jan 26
	9	Ed 2 Rev 15/07 aug 25
	10	Ed 2 Rev 5/02 nov 23
	11	Ed 2 Rev 5/02 nov 23
	12	Ed 2 Rev 5/02 nov 23
	13	Ed 2 Rev 5/02 nov 23
	14	Ed 2 Rev 5/02 nov 23
	15	Ed 2 Rev 5/02 nov 23
	16	Ed 2 Rev 5/02 nov 23
	17	Ed 2 Rev 5/02 nov 23
	18	Ed 2 Rev 5/02 nov 23
	19	Ed 2 Rev 5/02 nov 23
	20	Ed 2 Rev 5/02 nov 23
	21	Ed 2 Rev 5/02 nov 23
	22	Ed 2 Rev 5/02 nov 23
	23	Ed 2 Rev 5/02 nov 23
	24	Ed 2 Rev 9/14 jun 24
	25	Ed 2 Rev 9/14 jun 24
Chapt. 6		
6.1		
	1	Ed 2/20 apr 2022
	2	Ed 2/20 apr 2022
	3	Ed 2 Rev 7/04 jan 24
	4	Ed 2/20 apr 2022
	5	Ed 2/20 apr 2022
	6	Ed 2 Rev 6/15 nov 23
	7	Ed 2 Rev 3/26 may 23
	8	Ed 2/20 apr 2022
	9	Ed 2/20 apr 2022
	10	Ed 2/20 apr 2022
	11	Ed 2/20 apr 2022
	12	Ed 2/20 apr 2022
	13	Ed 2/20 apr 2022
	14	Ed 2/20 apr 2022
	15	Ed 2/20 apr 2022
	16	Ed 2/20 apr 2022
	17	Ed 2/20 apr 2022
	18	Ed 2/20 apr 2022
	19	Ed 2 Rev 10/30 oct 24
6.2		
	1	Ed 2/20 apr 2022

Part / Chapter	Pag.	Issue Date
	2	Ed 2 Rev 5/02 nov 23
	3	Ed 2/20 apr 2022
	4	Ed 2/20 apr 2022
	5	Ed 2/20 apr 2022
	6	Ed 2/20 apr 2022
	7	Ed 2 Rev 2/26 jan 23
	8	Ed 2/20 apr 2022
	9	Ed 2/20 apr 2022
	10	Ed 2 Rev 5/02 nov 23
6.3		
	1	Ed 2/20 apr 2022
	2	Ed 2 Rev 3/26 may 23
	3	Ed 2/20 apr 2022
Chapt. 7		
7.1		
	1	Ed 2/20 apr 2022
	2	Ed 2 Rev 12/28 feb 25
	3	Ed 2 Rev 12/28 feb 25
	4	Ed 2/20 apr 2022
7.2		
	1	Ed 2/20 apr 2022
	2	Ed 2 Rev 12/28 feb 25
	3	Ed 2 Rev 12/28 feb 25
7.3		
	1	Ed 2 Rev 8/15 mar 24
	2	Ed 2 Rev 8/15 mar 24
	3	Ed 2 Rev 8/15 mar 24
	4	Ed 2 Rev 8/15 mar 24
	5	Ed 2 Rev 8/15 mar 24
	6	Ed 2 Rev 8/15 mar 24
	7	Ed 2 Rev 8/15 mar 24
	8	Ed 2 Rev 12/28 feb 25
	9	Ed 2 Rev 12/28 feb 25
	10	Ed 2 Rev 8/15 mar 24
	11	Ed 2 Rev 8/15 mar 24
	12	Ed 2 Rev 8/15 mar 24
	13	Ed 2 Rev 8/15 mar 24
	14	Ed 2 Rev 8/15 mar 24
	15	Ed 2 Rev 8/15 mar 24
	16	Ed 2 Rev 8/15 mar 24
	17	Ed 2 Rev 8/15 mar 24
	18	Ed 2 Rev 8/15 mar 24
	19	Ed 2 Rev 8/15 mar 24
	20	Ed 2 Rev 8/15 mar 24

Part / Chapter	Pag.	Issue Date
7.4		
	1	Ed 2/20 apr 2022
	2	Ed 2/20 apr 2022
	3	Ed 2/20 apr 2022
	4	Ed 2/20 apr 2022
	5	Ed 2/20 apr 2022
	6	Ed 2/20 apr 2022
	7	Ed 2/20 apr 2022
	8	Ed 2/20 apr 2022
	9	Ed 2/20 apr 2022
	10	Ed 2/20 apr 2022
	11	Ed 2/20 apr 2022
	12	Ed 2/20 apr 2022
	13	Ed 2/20 apr 2022
	14	Ed 2/20 apr 2022
	15	Ed 2/20 apr 2022
	16	Ed 2/20 apr 2022
	17	Ed 2/20 apr 2022
	18	Ed 2/20 apr 2022
Chapt. 8		
8.1		
	1	Ed 2/20 apr 2022
8.2		
	1	Ed 2 Rev 6/15 nov 23
	2	Ed 2 Rev 5/02 nov 23
8.3		
	1	Ed 2/20 apr 2022
	2	Ed 2 Rev 8/15 mar 24
	3	Ed 2/20 apr 2022
	4	Ed 2/20 apr 2022
	5	Ed 2/20 apr 2022
	6	Ed 2/20 apr 2022
	7	Ed 2/20 apr 2022
	8	Ed 2/20 apr 2022
	9	Ed 2/20 apr 2022
	10	Ed 2/20 apr 2022
	11	Ed 2/20 apr 2022
8.4		
	1	Ed 2/20 apr 2022
	2	Ed 2 Rev 8/15 mar 24
	3	Ed 2 Rev 8/15 mar 24
	4	Ed 2/20 apr 2022
	5	Ed 2/20 apr 2022
	6	Ed 2 Rev 8/15 mar 24

REPORTING SYSTEM

 Volume II HLM	REPORTING SYSTEM	1.1	Page 1
	REPORTING SYSTEM & GROUND SAFETY REPORT (GSR)	Ed 2/20 apr 2022	

1.1 REPORTING SYSTEM & GROUND SAFETY REPORT (GSR)

Refer to GOM Chap. 0 "INTRODUCTION".

MESSAGES

 Volume II HLM	MESSAGES	2.1	Page 1
	GENERAL	Ed 2/20 apr 2022	

2.1 GENERAL

Operational Messages relating to the flown load on board the aircraft give important information to the final destination station, transit stations and to all departments involved in handling operations.

For all messages, automatic and manual, IATA standard formats must be used. Refer to the latest edition of the AHM (Airport Handling Manual) for the format tables.

Note:

Only three letter airport codes (i.e FCO, CIA) and not the city codes (i.e. ROM) must be used in messages.

Note:

In LDM and CPM messages, to provide information on special loads, the triletteral codes reported in Chap. 4.3.7 shall be used .

 Volume II HLM	MESSAGES	2.2	Page 1
	LOAD DISTRIBUTION MESSAGE (LDM)	Ed 2/20 apr 2022	

2.2 LOAD DISTRIBUTION MESSAGE (LDM)

2.2.1 GENERAL

Main purpose of the Load Distribution Message is to inform in advance final destination station, transit stations and involved departments about the arrival load.

Information inserted in the LDM shall match the ones shown on the Loading Instruction Report (LIR).

Message shall include all information concerning possible Last Minute Change (LMC) and Supplementary Information (SI) and must be sent immediately after flight departure.

If special loads needing specific storage temperature occur (i.e. AVI or PER), it is required to add a note in the SI in order to ensure a proper handling in the final destination and/or transit stations.

2.2.2 LDM FORMAT EXAMPLE

LDM

XX844/14.EIEJP.J20P17Y213.2/3/5

-LOS.74/48/3.T6434.2/1030.3/1052.4/4352.PAX/10/6/106.PAD1/0/0.PER/22P.PEP/31P

-ACC.51/3/1.T4427.2/1830.3/2429.5/168.PAX/2/1/51.EIC/20/53/168

SI CRB LDD H5

LOS.B 215/4572.C 15/1097.M NIL/NIL.TR NIL

ACC.B 95/2109.C 21/1873.M NIL/NIL.TR NIL

Following the definitions of the above example:

Item	Example
Message type	LDM
Flight number and scheduled date of departure	XX844/14
Aircraft registration	.EIEJP
Aircraft version	.J20P17Y213
Number of crew members (cockpit/cabin)	.2/3/5
First destination	-LOS
Numer of passengers per destination (male/female/children/ infants)	.74/48/0/3
Total weight of load including ULD tare	.T6434
Load weight per compartment	.2/1030.3/1052.4/4352
Number of passengers per class excluding infants	.PAX/10/6/106
Number of passengers off-loadable per class excluding infants	.PAD/0/0/3
Special load codes, positions and quantity (if applicable)	.PER/22P.PEP/31P
Subsequent destination - followed by same format load information described above	-ACC
Supplementary information (SI) - free text	SI
First destination	LOS
Baggage: number and net weight	.B 215/4572
Cargo: number and net weight	.C 15/1097
Mail: number and net weight	.M NIL/NIL
Transit Load: net weight	.TR NIL
Subsequent station - followed by baggage, cargo, mail and transit load in the same format described above	ACC

 Volume II HLM	MESSAGES	2.3	Page 1
	CONTAINER AND PALLET DISTRIBUTION MESSAGE (CPM)	Ed 2/20 apr 2022	

2.3 CONTAINER AND PALLET DISTRIBUTION MESSAGE (CPM)

2.3.1 GENERAL

Main purpose of the Container and pallet distribution message is to inform in advance final destination station, transit stations and involved departments about the ULD location on board, the type, the weight and the content.

Information inserted in the CPM shall match the ones shown on the Loading Instruction Report (LIR). Message shall include all information concerning possible Last Minute Change (LMC) and Supplementary Information (SI) and must be sent immediately after flight departure.

If special loads needing specific storage temperature occur (i.e. AVI or perishable cargo), it is required to add a note in the SI in order to ensure a proper handling in the final destination and/or transit stations.

2.3.2 CPM FORMAT EXAMPLE

CPM

XX844/17.EIEJJ.J20P17Y213
 -11L/AKE/LOS/192/C.RMD/4
 -11R/AKE/LOS/824/B
 -12P/N
 -13P/N
 -21P/PMC/LOS/1240/C
 -22P/PMC/LOS/1420/C.PER/12
 -31L/AKE/ACC/860/C
 -31R/AKE/ACC/716/B
 -32L/AKE/ACC/556/B
 -32R/AKE/ACC/470/B
 -33L/AKE/LOS/480/B
 -33R/AKE/ACC/470/B
 -41L/AKE/LOS/830/B
 -41R/AKE/LOS/830/B
 -42L/AKE/LOS/830/B
 -42R/AKE/LOS/830/B
 -43L/N
 -43R/N
 -51.NIL
 -52/LOS/64/B.AVI/4/ACC/114/B
 -53/ACC/168/C.EIC/20/168
 SI

Following the definitions of the above example:

Item	Example
Message type	CPM
Flight number and scheduled date of departure	XX844/17
Aircraft registration	.EIEJJ
Aircraft version	.J20P17Y213
Loading position/ ULD type/ destination / gross weight / load code / special code / number of pieces	-11L/AKE/LOS/192/C.RMD/4
Supplementary information (SI) - free text	SI

 Volume II HLM	MESSAGES	2.4	Page 1
	UNIT LOAD DEVICE CONTROL MESSAGE (UCM)	Ed 2/20 apr 2022	

2.4 UNIT LOAD DEVICE CONTROL MESSAGE (UCM)

2.4.1 GENERAL

Main purpose of the UCM (Unit Load Device Control Message) is to locate in real time single unit load devices and supply JETTWARE system.

Each telex shall include the address HDQAOXH (Jettainer).

UCM message includes the identification code of the ULD (IATA ID code) loaded on the Company containerized flights. Such message concerns both arriving ULD (UCM IN) and departing ULD (UCM OUT).

In case there are no ULD on board, UCM IIN or OUT message must be negative.

Note

Forwarding UCM OUT message is mandatory

2.4.2 UCM FORMAT EXAMPLE

UCM

XX0611/18.EIEJM.JFK

OUT

.AKE30362XX/FCO.AKE30756XX/FCO.AKE35270XX/FCO.AKE35859XX/FCO

.AKE30880XX/FCO.AKE35309XX/FCO.AKE35006XX/FCO

Following the definitions of the above example:

Item	Example
Message type	UCM
Flight number and scheduled date of departure	XX611/18
Aircraft registration	.EIEJM
Departure Station	.JFK
Header for outbound (departing) ULD	OUT
ULD serial number / station of destination (.N in case no ULD are on board)	.AKE30362XX/FCO

 Volume II HLM	MESSAGES	2.5	Page 1
	AIRCRAFT MOVEMENT MESSAGE (MVT)	Ed 2/20 apr 2022	

2.5 AIRCRAFT MOVEMENT MESSAGE (MVT)

2.5.1 GENERAL

Purpose of the Aircraft movement messages (MVT) is to indicate times of flight movement (departure or arrival of an aircraft). Besides they are basis for coordinating aircraft and crew rotations.

Note:

All Movement messages are listed in UTC time (Universal Time Coordinated)

MVT message types are:

- Departure message (**DEP**)
- Arrival message (**ARR**)
- Return to ramp message (**RET**)
- Delay message (**DLY**)
- Indefinite delay message (**NXT**)

DEP, ARR and RET messages must be sent respectively immediately after aircraft departure, arrival or return to ramp.

DLY messages must be sent when the duration of the delay can be estimated.

Note

DLY messages must be always sent when the delay is estimated in:

- 15 minutes for legs with a flight time less than two hours
- 30 minutes for legs with a flight time equal or greater than two hours

NXT messages must be sent when the delay cannot be estimated and reflects the time within which will be sent a further information.

2.5.2 MVT - DEPARTURE FORMAT EXAMPLE (DEP)

MVT

XX844/17.EIEJJ.FCO
AD1315/1334 EA1902 LOS
DL89/85/0010/0005
PX115/056
SI CPT/XXX

Following the definitions of the above example:

Item	Example
Message type	MTV
Flight number and scheduled date of departure	XX844/17
Aircraft registration	.EIEJJ
Station of departure	FCO
Actual off-block time / Actual take-off time	AD1315/1334
Estimated time of arrival at destination	EA1902 LOS
Delay (DL) followed by the delay code/s and the respective times (maximum 2 delay codes)(*)	DL89/85/0010/0005
Passengers (PX) followed by the total number of passengers on board excluding infants for the first destination / total number of passengers on board excluding infants for the second destination (if applicable)	PX115/056
Supplementary Information (SI) - free text	SI CPT/XXX

(*) To be used only in case of delay

 Volume II HLM	MESSAGES	2.5	Page 2
	AIRCRAFT MOVEMENT MESSAGE (MVT)	Ed 2/20 apr 2022	

2.5.3 MVT - ARRIVAL FORMAT EXAMPLE (ARR)

MVT

XX844/17.EIEJJ.LOS

AA1859/1910

Following the definitions of the above example:

Item	Example
Message type	MTV
Flight number and scheduled date of departure	XX844/17
Aircraft registration	.EIEJJ
Station of arrival	LOS
Actual landing time / Actual on-blocks time	AA1859/1910

2.5.4 MVT - DELAY FORMAT EXAMPLE (DLY)

MVT

XX844/17.EIEJJ.FCO

ED1340

DL89

SI ATC

Following the definitions of the above example:

Item	Example
Message type	MTV
Flight number and scheduled date of departure	XX844/17
Aircraft registration	.EIEJJ
Station of departure	FCO
Estimated time of departure	ED1340
Delay (DL) followed by the delay code	DL89
Supplementary information (SI) - free text	SI ATC

2.5.5 MVT - INDEFINITE DELAY FORMAT EXAMPLE (NXT)

MVT

XX844/17.EIEJJ.FCO

NI1410

SI ATC

Following the definitions of the above example:

Item	Example
Message type	MTV
Flight number and scheduled date of departure	XX844/17
Aircraft registration	.EIEJJ
Station of departure	FCO
Next information time	NI1410
Supplementary information (SI) - free text	SI ATC

 Volume II HLM	MESSAGES	2.5	Page 3
	AIRCRAFT MOVEMENT MESSAGE (MVT)	Ed 2/20 apr 2022	

2.5.6 MVT - RETURN TO RAMP FORMAT EXAMPLE (RET)

MVT

XX844/17.EIEJJ.FCO

AD1315 RR1320

SI ENGINE TROUBLE

Following the definitions of the above example:

Item	Example
Message type	MTV
Flight number and scheduled date of departure	XX844/17
Aircraft registration	.EIEJJ
Station of departure	FCO
Actual off-blocks time	AD1315
Actual return to stand time	RR1320
Supplementary information (SI) - free text	SI ENGINE TROUBLE

SPECIAL LOADS

 Volume II HLM	SPECIAL LOADS	3.1	Page 1
	INTRODUCTION	Ed 2/20 apr 2022	

3.1 INTRODUCTION

The purpose of this chapter is to define:

- Basic instructions to be observed on handling of SPECIAL CARGO,
- Loading Limitation.

This Chapter is meant to be integrated with the following reference documents and guidelines: IATA Live animal Regulations (LAR), IATA Perishable Cargo Regulations (PCR), IATA Temperature Control Regulations (TCR) and IATA Dangerous Goods Regulation (DGR).

 Volume II HLM	SPECIAL LOADS	3.2	Page 1
	DANGEROUS GOODS	Ed 2 Rev 13/28 mar 25	

3.2 DANGEROUS GOODS

3.2.1 GENERAL

“IATA Dangerous Goods Regulations” is the official document for handling, packing, marking and labelling, loading of dangerous goods.

Current edition of “IATA Dangerous Goods Regulations” manual further “addendum”, shall be available in the following areas of all network stations: Cargo, Check-in, Ramp, Load Control.



During handling, transporting and loading/unloading of Dangerous Goods the following rules shall be observed:

- Only trained and qualified personnel is allowed to handle DG shipment in accordance with his/her job role.
- Packages, Overpacks or ULDs containing Dangerous Goods must be protected from being damaged.
- It is mandatory to tie-down Dangerous Goods consignments. If shape and dimensions of a Dangerous Good consignment precludes the tied down of the package, then it must be blocked with other load to prevent movement which could change its position or orientation.
- Packages bearing Orientation label (This way Up-label) must be handled at all times in accordance with such label.
- Packages with end closures, containing liquid Dangerous Goods must be handled and loaded with such closures in an upwards direction (if applicable).
- Dangerous Goods must never be carried in the passenger cabin or in the flight Deck on Passengers flights, with exception of allowed articles as described in Table 2.3.A of IATA DGR.
- Dangerous Goods must be separated and segregated according to IATA DGR Manual table 9.3.A due to prevent interaction in the event of leakage.

 Volume II HLM	SPECIAL LOADS	3.2	Page 2
	DANGEROUS GOODS	Ed 2/20 apr 2022	

- Dangerous Goods may be loaded on board provided that the indicated net quantities are not exceeding the allowable according to IATA DG Manual, and that the applicable packing instructions are strictly respected.
- Packages of Dangerous Goods bearing the label "CARGO AIRCRAFT ONLY" shall be loaded only on "ALL CARGO" aircraft.
- Some categories of dangerous articles are not compatible with other types of cargo or goods, such as live animals or food products. In these cases IATA and Company regulations must be followed (see 3.2.5).
- Protect the bases of the drums with planks on edge on the exterior of the pallet load or by raising the drums.
- Drums must be exclusively palletized vertically, maximum allowed 3 levels (2 levels for 220 L drums).

Note: Loading and securing of DG shall always be performed under the supervision of a qualified person (i.e. Team Leader, Loading Supervisor).

 Volume II HLM	SPECIAL LOADS	3.2	Page 3
	DANGEROUS GOODS	Ed 2/20 apr 2022	

3.2.2 CLASSIFICATION

DG are divided into 9 classes (DGR 3.02); classes 1,2,4,5 and 6 are divided into Divisions due to Hazard variations within these classes.

3.2.2.1 Class 1 - Explosives

NORMALLY FORBIDDEN FOR CARRIAGE BY AIR.

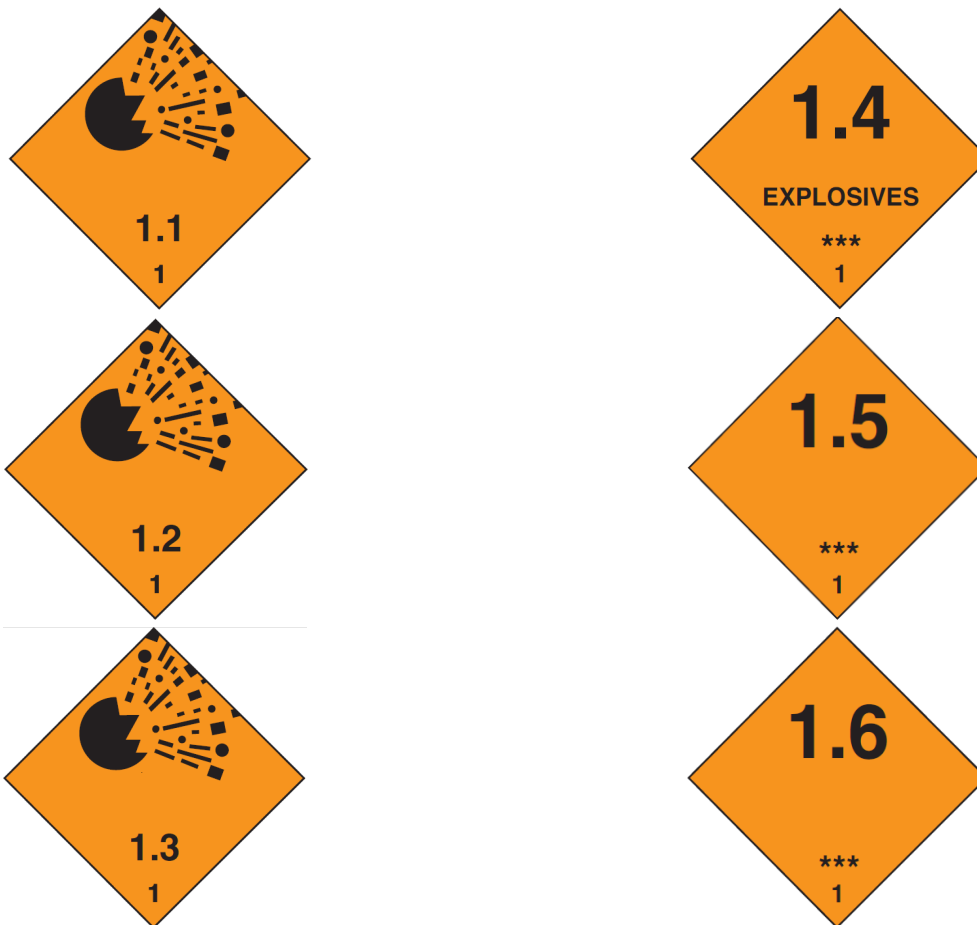

ALLOWED ON PAX AIRCRAFT

Articles and substances which present no significant hazard.

Effect from accidental functioning is confined within the package (e.g. Ammunition for hand weapons for signal and some types of fireworks).



 ITA AIRWAYS Volume II HLM	SPECIAL LOADS	3.2	Page 4
	DANGEROUS GOODS	Ed 2/20 apr 2022	

ALLOWED ON CARGO AIRCRAFT ONLY



3.2.2.2 Class 2 - Gases

3.2.2.2.1 Division 2.1 - RFG

Any gas which, when mixed with air in certain proportions, forms a flammable mixture (e.g. Butane, Hydrogen, Propane, Acetylene, Lighters).



 Volume II HLM	SPECIAL LOADS	3.2	Page 5
	DANGEROUS GOODS	Ed 2/20 apr 2022	

3.2.2.2 Division 2.2 - RNG/RCL

Any non-flammable, non toxic gas or refrigerate liquefied gas (e.g. Carbon dioxide, Neon, Fire Extinguisher, liquefied Nitrogen o Helium).



3.2.2.3 Division 2.3 - RPG

Gases known to be toxic or corrosive to humans and known to pose a health risk. Most toxic gases are forbidden for carriage by air; some are permitted (e.g. Aerosols of low toxicity, tear gas devices).



3.2.2.3 Class 3 - Flammable Liquids

Any liquid having a closed cup flash point of 60 °C or below.
(e.g. Certain Paints, Alcohols, some Adhesives, Acetone, Petrol, Varnishes, etc.)



 Volume II HLM	SPECIAL LOADS	3.2	Page 6
	DANGEROUS GOODS	Ed 2/20 apr 2022	

3.2.2.4 Class 4 - Flammable Solids

3.2.2.4.1 Division 4.1 - RFS

Any solid material, which is readily combustible, or may cause or contribute to fire through friction (e.g. Matches, Sulphur Celluloid, Nitronaphthalene).

Note: Some Flammable Solids are self reactive.



3.2.2.4.2 Division 4.2 - RSC

Such substances are liable to spontaneous heating or to heating up in contact with air and then liable to catch fire (e.g. White or Yellow phosphorus, Magnesium diamide).



3.2.2.4.3 Division 4.3 - RFW

Substances, which, by interaction with water, are liable to become spontaneously flammable or to give off flammable gases (e.g. Calcium carbide, Sodium).



 Volume II HLM	SPECIAL LOADS	3.2	Page 7
	DANGEROUS GOODS	Ed 2/20 apr 2022	

3.2.2.5 Class 5 - Oxidizing Substance; Organic Peroxide

3.2.2.5.1 Division 5.1 - ROX

A substance that yields oxygen readily to stimulate the combustion of other material (e.g. Ammonium nitrate fertilizer, Calcium chlorate, Bleaches).



3.2.2.5.2 Division 5.2 - ROP

An organic material (liquid or solid) that can be ignited readily by external flame and then burns with an accelerating rate; some substances react dangerously with others (e.g. Hydrogen Peroxide, tert-butyl hydro peroxide, hardeners for fibreglass, repair kits).

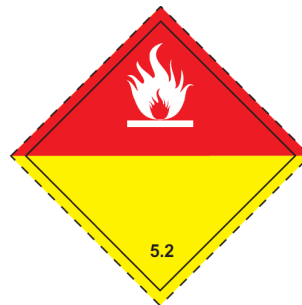

3.2.2.6 Class 6 - Toxic Substance; Infectious Substance

3.2.2.6.1 Division 6.1 - RPB

Liquids or solids which are dangerous if inhaled, swallowed or absorbed through the skin (e.g. Arsenic, Nicotine, Cyanide, Pesticides, Strychnine).

Some are totally forbidden as Bromoacetone.



 Volume II HLM	SPECIAL LOADS	3.2	Page 8
	DANGEROUS GOODS	Ed 2/20 apr 2022	

3.2.2.6.2 Division 6.2 - RIS

Substances which are known or reasonably expected to contain pathogens and cause disease in humans or in animals (e.g. Virus, Bacteria, such as HIV (AIDS), Rabies, some diagnostic specimens, biological products and Medical waste).



3.2.2.7 Class 7 - Radioactive Material

3.2.2.7.1 Category I White - RRW

Radioactive materials with low radiation level on the package surface which there are no particular restrictions.



3.2.2.7.2 Category II Yellow - Transport index not exceeding 1.0 - RRY



 Volume II HLM	SPECIAL LOADS	3.2	Page 9
	DANGEROUS GOODS	Ed 2 Rev 1/15 oct 2022	

3.2.2.7.3 Category III Yellow - Transport index between 1.1 and 10 - RRY



3.2.2.7.4 Category Fissile

Critically safety index labels must be used in addition to the appropriate radioactive labels to provide control over accumulation of packages or overpacks containing fissile material.

Fissile material: Uranium 233 and 235, Plutonium 239 and 241.

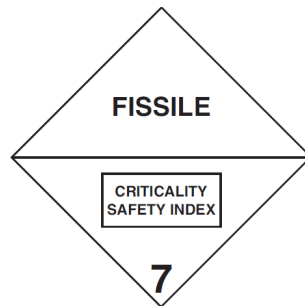

3.2.2.8 Class 8 - Corrosive

A liquid or solid that will cause severe damage when in contact with living tissue or in case of leakage will materially damage or even destroy other goods or the means of transport (e.g. Battery acids, Sulphuric and other acids, potassium hydroxide).



 Volume II HLM	SPECIAL LOADS	3.2	Page 10
	DANGEROUS GOODS	Ed 2 Rev 3/26 may 23	

3.2.2.9 Class 9 - Miscellaneous Dangerous Goods

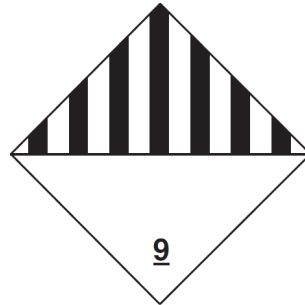

For packaging containing "**Lithium Ion**" and "**Lithium Metal**" batteries, the following label is used:



3.2.2.9.1 RMD

Any substance which presents a danger during air transportation that is not covered by other classes (e.g. Asbestos, Garlic Oil, Life Rafts, Internal Combustion Engines, Vehicles).

3.2.2.9.2 RSB

Semi-processed polymeric articles impregnated with a flammable gas or liquid as a blowing agent; they may evolve small quantities of flammable gas.

3.2.2.9.3 Carbon dioxide, solid (dry ice) - ICE

Carbon dioxide, solid (dry ice) has a temperature of -79 °C. On sublimation it produces a gas heavier than air which in an enclosed area and in larger quantities can lead to suffocation.

3.2.2.9.4 Magnetic material - MAG

These materials must be loaded in locations minimizing effects on aircraft compasses (e.g. Masses of ferromagnetic metals such as automobiles, automobile parts).

Note: For MAG only the handling label must be used.

Magnetic material (MAG) must be loaded a minimum of 4.6 metres away from the cockpit so that it does not significantly affect the direct magnetic compass reading.

 Volume II HLM	SPECIAL LOADS	3.2	Page 11
	DANGEROUS GOODS	Ed 2 Rev 17/27 jan 26	



For A220 aircraft:

magnetic material shall be loaded preferably in the aft hold.

If necessary, section 12 of the forward hold can be used, yet magnetic material shall be positioned at least 1 meter from the dividing net with section 11

3.2.3 CLASS 2.1, 3 AND 4 POSITIONING ON BOARD



For wide-body aircraft

Flammable and combustible belonging to class 2.1, 3 and 4 shall be necessarily loaded together in the aft hold compartment 3-4 (aft).

Segregation criteria shall be always respected (i.e. in case of lithium batteries, they shall be loaded exclusively in the fwd compartments)

For A321/neo

Flammable and combustible belonging to class 2.1, 3 and 4 shall be necessarily loaded together in the aft hold compartment 3-4 (aft) or in hold 5.

Segregation criteria shall be always respected (i.e. in case of lithium batteries, they shall be loaded exclusively in the fwd compartments)

For A320F and A320 neo aircraft

Flammable and combustible belonging to class 2.1, 3 and 4 shall be necessarily loaded together in the forward hold compartment 1-2 or in hold 5 (fwd o H5).

Segregation criteria shall be always respected (i.e. in case of lithium batteries, they shall be loaded exclusively in the aft compartment).

For A220 aircraft

Flammable and combustible belonging to class 2.1, 3 and 4 can be loaded together in the aft hold, complying with the segregation requirements.

 ITA AIRWAYS Volume II HLM	SPECIAL LOADS	3.2	Page 12
	DANGEROUS GOODS	Ed 2/20 apr 2022	

3.2.4 HANDLING LABELS AND MARKINGS

3.2.4.1 Label - Magnetized Material (MAG)

These materials have relatively high magnetic field strength (e.g. Magnetrons and non shielded, permanent magnets without keeper bars installed).

Class 9 label is not required with magnetized material.

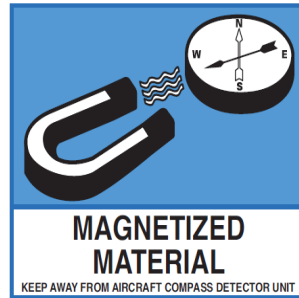

3.2.4.2 Label - Cargo Aircraft Only (CAO)

Must never be loaded on board passenger aircraft.



3.2.4.3 Label - Package orientation

Package with these label must be stowed in upright position to prevent any risk of spillage.

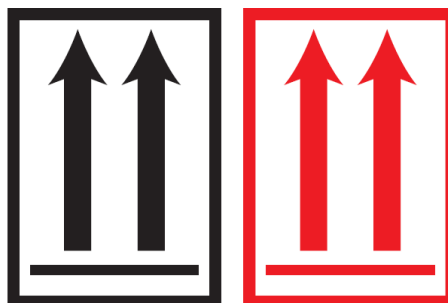

 Volume II HLM	SPECIAL LOADS	3.2	Page 13
	DANGEROUS GOODS	Ed 2/20 apr 2022	

3.2.4.4 Label - Cryogenic liquid (RCL)

This label must be used in addition to the division 2.2 hazard label on packages and overpacks containing cryogenic liquids (refrigerated liquefied gas).

The label highlights that gas may flow from venting device because it is very cold resulting in water vapour condensation in the air which can look like smoke. This phenomenon is normal and no dangerous.

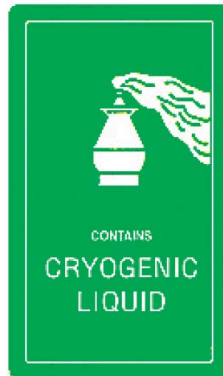

3.2.4.5 Label - Radioactive Material Excepted Package (RRE)

This label must be affixed to all excepted packages of Radioactive Material.

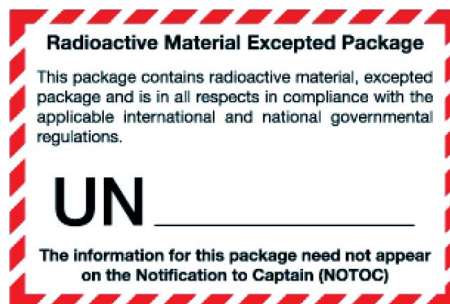

3.2.4.6 Label - Keep away from Heat

This label must be applied on packages and overpacks containing self-reactive substances in division 4.1 and division 5.2.



 ITA AIRWAYS Volume II HLM	SPECIAL LOADS	3.2	Page 14
	DANGEROUS GOODS	Ed 2/20 apr 2022	

3.2.4.7 Package marking - Lithium Batteries

This label must be applied on packages of lithium batteries when required.



3.2.4.8 Label - Battery powered Wheelchairs or Mobility

This label may be attached to the battery powered wheelchair or mobility aid to assist with the handling of wheelchairs and mobility aids with batteries. The label may be used to assist in identifying whether or not a wheelchair has had the battery removed.

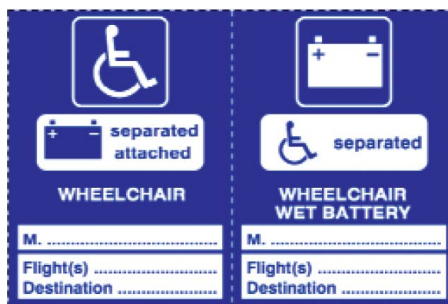

3.2.4.9 Package marking - Marking Excepted Quantities (REQ)

This mark must be applied on packages of dangerous goods shipped in excepted quantities (smaller amount).



 Volume II HLM	SPECIAL LOADS	3.2	Page 15
	DANGEROUS GOODS	Ed 2/20 apr 2022	

3.2.4.10 Package marking - Environmentally Hazardous Substance

This mark must be applied on packages containing environmentally hazardous substance (e.g. aquatic environment).



3.2.4.11 Package marking - Limited quantity LTD QTY

This mark must be applied on packages of dangerous goods shipped under Limited Quantity provision.

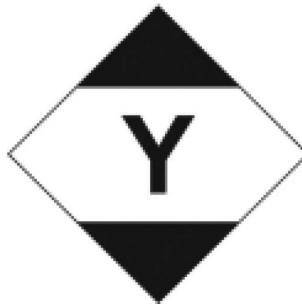

3.2.4.12 Consumer labels not to be considered

Many "household" products are required under national legislation to carry product or consumer warning notices and labels. These do not necessarily mean that the goods are dangerous, but that the use requires caution.

These labels must not be confused with the labels used for the transport of dangerous goods.



 Volume II HLM	SPECIAL LOADS	3.2	Page 16
	DANGEROUS GOODS	Ed 2 Rev 1/15 oct 2022	

3.2.5 RADIOACTIVE MATERIAL LOADING AND SEGREGATION

Transportation is limited by the maximum value of transport indexes allowed for the type of aircraft or per cargo compartment respectively.

The value of transport indexes must be entered on the special label affixed on each item.

Groups of packages exceeding the allowed number of Transport Index must be separated into smaller groups.

When in groups the separation distance must be applied according to the group with the higher transport index; the total value of transport indexes of all the items must not exceed the maximum amount for the compartment/aircraft type.

The vertical distance must be calculated according to the table A (shown below), while the minimum separation distance (horizontal) from each other group or individual package must be at least three times the minimum separation distance (vertical) applicable to the one that has the higher sum of transport index.

The table A specifies the minimum separation distance between the surfaces of each RRY item (or group of items) and the floor surface of the passenger cabin or cockpit, independent from flight duration.

Packages exceeding the allowed package height must not be loaded.

TAB. A		
VERTICAL AND LONGITUDINAL DISTANCE DUE TO TRANSPORT INDEX		
TRANSPORTATION INDEX (T.I.)	MINIMUM DISTANCE FROM CABIN PAX FLOOR (cm)	LONGITUDINAL DISTANCE BETWEEN ITEMS (cm)
From 0,1 to 1,0	30	90
1,1 to 2,0	50	150
2,1 to 3,0	70	210
3,1 to 4,0	85	255
4,1 to 5,0	100	300
5,1 to 6,0	115	345
6,1 to 7,0	130	390
7,1 to 8,0	145	435
8,1 to 9,0	155	465
9,1 to 10,0	165	495

MAXIMUM ALLOWABLE PACKAGE HEIGHT FOR AIRCRAFT TYPE									
TRANSPORT INDEX (T.I.)	AIRCRAFT TYPE								
	A350 (cm)		A330 (cm)		A319/A320 neo A320/A321 neo		A220-100/A220-300 (cm)		
	cmpt 1-2-3-4	cmpt 5	cmpt 1-2-3-4	cmpt 5	cmpt 1-2-3-4	cmpt 5	cmpt 1-4C*	cmpt 4F*	
0.1 1.0	152	105	165	140	105	67	85	54	
1.1 2.0	132	85	145	120	85	47	65	34	
2.1 3.0	112	65	125	100	65	27	45	14	
3.1 4.0	97	50	110	85	50	12	30	n/a	
4.1 5.0	82	35	95	70	35	n/a	15	n/a	
5.1 6.0	67	20	80	55	20	n/a	n/a	n/a	
6.1 7.0	52	5	65	40	n/a	n/a	n/a	n/a	
7.1 8.0	37	n/a	50	25	n/a	n/a	n/a	n/a	
8.1 9.0	27	n/a	40	15	n/a	n/a	n/a	n/a	
9.1 10.0	17	n/a	30	n/a	n/a	n/a	n/a	n/a	

*4C and 4F are in the aft hold

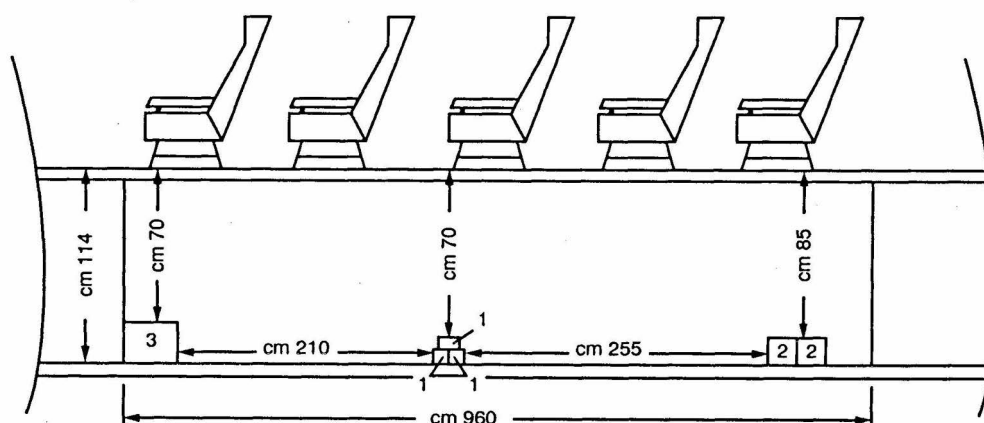

3.2.5.1 Radioactive Material Segregation and FIL

Undeveloped films or plates (FIL) must be loaded far from RRY radioactive material, so that the minimum separations are respected as indicated in the following table and valid for transport up to 48 hours:

TOTAL SUM OF TRANSPORT INDEXES	DURATION OF CARRIAGE											
	2 hours or less		2-4 hours		4-8 hours		8-12 hours		12-24 hours		24-48 hours	
	cm	inch	cm	inch	cm	inch	cm	inch	cm	inch	cm	inch
1	40	16	60	24	90	36	110	44	150	59	220	87
2	60	24	80	32	120	48	150	59	220	87	310	122
3	70	28	100	40	150	59	180	71	260	103	380	150
4	80	32	120	48	170	67	220	87	310	122	440	174
5	80	32	130	52	190	75	240	95	340	134	480	189
10	140	56	200	79	280	111	350	138	490	193	690	272
20	200	79	280	111	400	158	490	193	690	272	1000	394
30	240	95	350	138	490	193	600	237	860	339	1200	473
40	290	115	400	157	570	225	690	271	1000	394	1400	552
50	320	126	450	178	630	248	790	311	1100	433	1600	630

- The table is calculated so that the radiation received by the films does not exceed 2,6 microcoulomb/Kg (10 milliroentgen).
- The transport index sum refers to the RRY items loaded in a group.

 Volume II HLM	SPECIAL LOADS	3.2	Page 20
	DANGEROUS GOODS	Ed 2 Rev 17/27 jan 26	

The intersection with:

X	Requires segregation with classes/divisions as per DGR Table 9.3.A. Classes/divisions not included in the table above, do not require segregation.
1	Requires segregation with cryogenic liquids (RCL) and carbon dioxide, solid (ICE) as per DGR 9.3.13.1. Live animals (AVI) should not be loaded in close proximity of cryogenic liquids (RCL) and carbon dioxide, solid (ICE). Live animals (AVI) should be stowed above packages containing carbon dioxide, solid (ICE).
2	Requires segregation with radioactive material Category II and III (RRY). Minimum separation distance when loading RRY with live animals (AVI): 0.5m or more for journeys up to 24 hours, 1.0 m or more for journeys of more than 24 hours as per Minimum separation with undeveloped film (FIL) as per table DGR 10.9.E.
3	May require segregation with live animals (AVI), hatching eggs (HEG) and day old chicken (DOC).
4	May require segregation with foodstuff (EAT - includes PEM, PEP, PES) and perishables (PER).
5	May require segregation with human remains (HUM).

IMP codes

Please refer to latest DGR edition or internal operations manual for further details

IMP Code	Meaning	Class/Division
REX	To be reserved for normally forbidden Explosives	1.1, 1.2, 1.3, 1.4F, 1.5 and 1.6
RCX	Explosives (CAO)	1.3C
RGX	Explosives (CAO)	1.3G
RXB	Explosives	1.4B
RXC	Explosives	1.4C
RXD	Explosives	1.4D
RXE	Explosives	1.4E
RXG	Explosives	1.4G
RXS	Explosives	1.4S
RFG	Flammable Gas	2.1
RNG	Non-Flammable Non-Toxic Gas	2.2
RCL	Cryogenic Liquid (Packing Instruction 202)	2.2
RPG	Toxic Gas	2.3
RFL	Flammable Liquid	3
RFS	Flammable Solid	4.1
RSC	Spontaneously Combustible	4.2
RFW	Dangerous When Wet	4.3
ROX	Oxidizer	5.1
ROP	Organic Peroxide	5.2
RPB	Toxic Substance	6.1
RIS	Infectious Substance (UN 2814 or UN 2900)	6.2
RRW	Radioactive Material Category I-White	7
RRY	Radioactive Material Categories II-Yellow and III-Yellow	7
RCM	Corrosive	8
RMD	Miscellaneous Dangerous Goods	9
ICE	Carbon dioxide, solid (dry ice)	9
MAG	Magnetized Material	9
RSB	Polymeric Beads/Plastics Moulding Compound (Packing Instruction 957)	9
RBI	Fully regulated lithium ion batteries (UN 3480) as per Section IA and IB of PI 965 or sodium ion batteries (UN 3551) as per PI 976	9
RBM	Fully regulated lithium metal batteries (UN 3090) as per Section IA and IB of PI 968	9
RLI	Fully regulated lithium ion batteries (UN 3481) as per Section I of PI 966 and 967 or sodium ion batteries (UN 3552) as per Section I of PI 977 and PI 978	9
RLM	Fully regulated lithium metal batteries (UN 3091) as per Section I of PI 969 and 970	9
RVB	Vehicle, Battery Powered	9
RVF	Vehicle, Flammable, Gas or Liquid Powered	9
RVH	Vehicle, Hybrid	9
RVO	Vehicle Other	9

Other Special Load

IMP Code	Meaning
AVI	Live animal
DOC	Day old chick
EAT	Foodstuff
ELI	Lithium ion batteries excepted as per Section II of PI 966 and 967 or sodium ion batteries excepted as per Section II of PI 977 and PI 978
ELM	Lithium metal batteries excepted as per Section II of PI 969 and 970
FIL	Undeveloped films/Unexposed films
HEG	Hatching eggs
HUM	Human remains
LHO	Living human organs/blood
PEA	Hunting trophies, skin and all articles made from or containing part of species listed in CITES
PEF	Flowers
PEM	Meat
PEP	Fruits and vegetables
PER	Perishables
PES	Seafood/fish for human consumption
PIL	Pharmaceutical products
VAL	Valuable cargo

Handling

IMP Code	Meaning
CAO	Cargo Aircraft Only

3.2.7 DRY ICE

The following table, in Kg, shows the maximum quantity of dry ice permitted as per fleet type.

AA/MM	COMPARTMENT					TOTAL QUANTITY FOR A/C
	1	2	3	4	5	
A350	1300		1300		100	1300
A330 200 A330 900	1000		0	0	200	1000
A320/200 A320/neo	0		250			250
A319	0			250		250
A220	200			200		400

Quantities described in the column "total quantity for a/c represent the maximum limit for aircraft type, consequently the load distribution can be performed exclusively in the allowed compartments without exceeding limitations.

Note: to avoid suffocation, before entering a confined space where Carbon Dioxide solid (dry ice) has been loaded or stored, ensure adequate ventilation has occurred. It is recommended to wait for a minimum of 2 minutes for ventilated cargo compartment and 10 minutes for not ventilated cargo compartment.

 Volume II HLM	SPECIAL LOADS	3.2	Page 22
	DANGEROUS GOODS	Ed 2 Rev 17/27 jan 26	

3.2.8 WHEELCHAIR OR MOBILITY AIDS HANDLING AND LOADING

Wheelchairs or mobility aids (hereinafter referred to as "devices") integrity shall always be safeguarded as these equipments are of vital importance for people with disabilities, guaranteeing them freedom and autonomy of movement.

Transfer to the aircraft parking area (if remote) shall be made on a cart, the device shall be braked and constrained. Once positioned in front of the hold, it shall be lifted by the necessary number of operators and placed on the belt.

The belt can only be used if the wheels of the device remain inside the belt, the device shall be braked and locked.

In order to prevent possible devices damage during loading, the following instructions shall be observed:

- load the devices in dedicated ULDs or compartments, separately from any other load, if weight/volume flight conditions allow it;
- load in such a way as to prevent the devices free movement and/or any other load (i.e. baggage, mail and cargo) within the ULD/hold;
- keep device upright, if possible;
- avoid unnecessary device tilting;
- disengage freewheel mode;
- secure removable and fragile parts;
- for battery-powered devices, refer to procedures described in the following paragraphs.

The devices restraint can be ensured:

- with the use of straps, avoiding to over tighten them and being careful to place them in points that are not sensitive parts easily damaged. If possible, use tie down points or device base;
- with the use of other material to be loaded. This load shall be placed only on the device sides (not on top) and its nature shall not be such as to damage the device (i.e. dangerous goods, piercing loads or loads that could potentially leak liquids).

The following table shows the maximum dimensions allowed for the loading of mobility aids in aircraft holds:

WCH MAXIMUM DIMENSIONS (cm)			
Aircraft	Length	Width	Height
A350 / A339 / A332	151	148	157
A321 / A320 / A319	151	148	109
A321 / A320 / A319 when used in bulk load mode	96	116	80
A221 / A223	96	116	80

 ITA AIRWAYS Volume II HLM	SPECIAL LOADS	3.2	Page 23
	DANGEROUS GOODS	Ed 2 Rev 17/27 jan 26	

3.2.8.1 Wheelchairs/Mobility Aids with spillable batteries

Wheelchairs and mobility aids powered by spillable batteries must always be loaded, stowed, secured and unloaded in upright position. If the wheelchair or mobility aid does not adequately protect the battery, the battery must be removed and the wheelchair checked as baggage; the removed battery/ies must be carried in the cargo compartment in strong and rigid package as follows:

- a. Packaging must be leak-tight, impervious to battery fluid and be protected against upset by securing to pallets or by securing them in cargo compartments using appropriate means of securement (other than by bracing with freight or baggage) such as by use of restraining straps;
- b. battery(ies) must be protected against short circuits, secured upright in these packagings and surrounded by compatible absorbent material sufficient to absorb their total liquid contents; and
- c. these packagings must be marked **“BATTERY, WET, WITH WHEELCHAIR”** or **“BATTERY, WET, WITH MOBILITY AID”** and be labelled with the “Corrosive” label and with the “Package Orientation” label.

Note: The captain must be informed of the location of the packed battery or of the wheelchair.

The loading team must secure, by use of straps, tie-downs or other restraint devices, a battery powered mobility aid with installed battery(ies). The mobility aid, the battery(ies), electrical cabling and controls must be protected from damage including by the movement of baggage, mail or cargo.

The loading team must verify that:

- a. the battery terminals are protected from short circuits;
- b. the battery(ies) is fitted, where feasible, with spill-resistant vent caps;
- c. the battery(ies) is either:
 1. adequately protected against damage by the design of the mobility aid and securely attached to the wheelchair or mobility aid. The electrical circuits must be isolated following the manufacturer’s instructions; or
 2. removed from the mobility aid following the manufacturer’s instructions when the mobility aid cannot be maintained in an upright position.



 ITA AIRWAYS Volume II HLM	SPECIAL LOADS	3.2	Page 24
	DANGEROUS GOODS	Ed 2 Rev 17/27 jan 26	

3.2.8.2 Wheelchairs / Mobility Aids with non-spillable wet batteries, nickel-metal hydride batteries or dry Batteries

This category consists of wheelchairs and mobility aids powered by one of three different types of batteries.

Non-spillable wet batteries must comply with Special Provision A67.

Special Provision A67: Wet cell batteries can be considered as non-spillable provided that they are capable of withstanding the vibration and pressure differential tests, without leakage of battery fluid. A passenger may carry a maximum of **one** spare wet, non-spillable battery meeting Special Provision A67.

Nickel-metal hydride batteries must comply with Special Provision A199.

Special Provision A199: Nickel-metal hydride batteries or nickel-metal hydride battery-powered devices, equipment or vehicles having the potential of a dangerous evolution of heat are not subject to these Regulations (DGR) provided they are prepared for transport so as to prevent:

- a short circuit (e.g. in the case of batteries, by the effective insulation of exposed terminals; or, in the case of equipment, by disconnection of the battery and protection of exposed terminals); and
- unintentional activation.

A passenger may carry a maximum of **two** spare nickel-metal hydride batteries meeting Special Provision A199.

Dry batteries must comply with Special Provision A123.

Special Provision A123: Examples of such batteries are: alkali-manganese, zinc-carbon and nickel-cadmium batteries. Any electrical battery or battery-powered device, equipment or vehicle having the potential of a dangerous evolution of heat must be prepared for transport so as to prevent:

- a short circuit (e.g. in the case of batteries, by the effective insulation of exposed terminals; or, in the case of equipment, by disconnection of the battery and protection of exposed terminals); and
- unintentional activation.

A passenger may carry a maximum of **two** spare dry batteries meeting Special Provision A123.

All removed and spare batteries must be carried in strong, rigid packagings and must only be carried in the cargo compartment.



 Volume II HLM	SPECIAL LOADS	3.2	Page 25
	DANGEROUS GOODS	Ed 2 Rev 17/27 jan 26	

3.2.8.3 Wheelchairs / Mobility Aids with Lithium Batteries

Lithium batteries that are used to power the wheelchairs and mobility aids must be of a type which meets the requirements of each test in the UN Manual of Tests and Criteria, Part III, subsection 38.3. The lithium battery(ies) can either **remain installed** in the wheelchair or mobility aid, if the battery(ies) is protected against damage by the design and securely attached or be removed, following the manufacturer's instructions.

The removed battery(ies) must not exceed **300 Wh**. The battery **MUST BE** removed for carriage where the design of the wheelchair or mobility aid **does not provide adequate protection** and that the battery(ies) is not securely attached to the device.

There is no limit to the Watt-hour (Wh) rating if the battery(ies) remain installed.

A passenger may carry a maximum of **one** spare battery not exceeding **300 Wh** or **two** spare batteries each not exceeding **160 Wh**.

All removed and **spare batteries** must be protected from damage (e.g. by placing each battery in a protective pouch) and **must only be carried in the passenger cabin**.

The wheelchair must be carried always in upright position in the cargo compartment.

Note: The captain must be informed of the location of the WCHR or mobility aid with battery installed or of the location of the lithium battery if removed and carried in cabin.

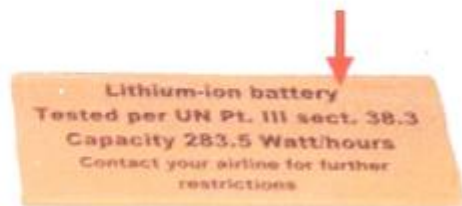

 Volume II HLM	SPECIAL LOADS	3.2	Page 26
	DANGEROUS GOODS	Ed 2 Rev 17/27 jan 26	

3.2.9 DANGEROUS GOODS DAMAGED OR LEAKING



Caution:

In any case when a DG is leaking do not smell, touch or ingest the substance. Fatal injury may occur!

If the DG substance has been kept in contact with your clothes or your body immediate actions shall be taken as follows:

- undress contaminated clothes immediately,
- wash your body with water,
- do not drink, eat or smoke,
- maintain hands away from your eyes, mouth and nose,
- contact a Doctor for first Aid.

3.2.9.1 Before loading

Packages or shipments containing Dangerous Goods must be inspected for signs of damage or leakage prior to release for loading into the aircraft or ULDs. If there is evidence or doubt of damage or leakage or smell because the package or the ULDs is not in good condition, the operators involved shall immediately report to Ramp Supervisor.

The Ramp Supervisor shall:

- alert the Station Control Center,
- require directly, as per local regulations, the technical intervention team (in Italy is the Fire Brigade) to initiate the Local Emergency Response Plan,
- inform the Company Representative,
- notify the event to Captain, coordinating to disembark passengers and crew, if necessary,
- report to the applicable Authority.

If evidence of damage or leakage is found, an evaluation is conducted to identify and prevent from transport any other baggage, cargo or equipment that has become contaminated by such leakage.

3.2.9.2 In cargo compartments

Once loaded or prior unloading, packages or ULDS, containing Dangerous Goods, must be inspected for signs of damage or leakage. If there is evidence or doubt of damage or leakage or smell because the package or the ULDs is not in good condition, the operators involved shall immediately escape from the compartment, close the cargo door and report to the Ramp Supervisor.

 Volume II HLM	SPECIAL LOADS	3.2	Page 27
	DANGEROUS GOODS	Ed 2 Rev 17/27 jan 26	

The Ramp Supervisor shall:

- alert the Station Control Center,
- require directly, as per local regulations, the technical intervention team (in Italy is the Fire Brigade) to initiate the Local Emergency Response Plan,
- inform the Company Representative,
- notify the event to Captain, coordinating to disembark passengers and crew, if necessary,
- report to the applicable Authority.

If evidence of damage or leakage is found, the packages or ULDs must be removed from the aircraft without delay and an evaluation is conducted to identify and prevent from transport any other baggage, cargo or equipment that has become contaminated by such leakage.

When an aircraft has been contaminated by radioactive material leakage, arrangements are made to take the aircraft out of service for evaluation by appropriately qualified personnel.



Caution:

The position where the packages or ULDs containing Dangerous Goods was stowed on the aircraft must be inspected for damage or contamination by qualified personnel (according to the type of DG) and any hazardous contamination removed.

Loading/unloading operations in the remaining compartments, if not adjacent, can proceed regularly, if safety is not at risk.

Note: Any occurrence related to Dangerous goods shall be notify as per Company regulation.

Note: In case of occurrence related to Dangerous goods, all concerned material (dangerous good, packaging, documents, etc.) should be retained until after the initial report has been sent to the local authority and they have indicated whether or not these should continue to be retained, unless otherwise indicated by the same local authority.

 Volume II HLM	SPECIAL LOADS	3.2	Page 28
	DANGEROUS GOODS	Ed 2 Rev 17/27 jan 26	

According to the specific DG involved specific action must be taken according to the table below:

HAZARD CLASS OR DIVISION AND COMPATIBILITY GROUP/ CATEGORY		CODE	DANGEROUS GOOD CLASS	HAZARD DESCRIPTION	IMMEDIATE ACTION
1.3 C 1.3 G	C A O O N L Y	RCX RGX	Explosives	Fire and minor blast hazard and/or minor propulsive hazard	Alert Fire Department Guard
1.4 B 1.4 C 1.4 D 1.4 E 1.4 G		RXB RXC RXD RXE RXG	Explosives	Fire, but no other significant hazard	
1.4 S		RXS	Explosives (safe)	Small fire hazard	
2.1 2.2 2.2 2.3		RFG RNG RCL RPG	Flammable Gas Non-Flammable Gas Cryogenic Liquid Toxic Gas (CAO only)	Ignites when leaking High pressure Cylinder bursting Sub cooling High pressure Cylinder bursting and toxic inhalation.	Notify Fire Department Guard against fire Evacuate goods-ventilate area Keep away minimum 25 m
3		RFL	Flammable Liquid	Gives off flammable vapours	Notify Fire Department Guard against fire Do not use water under any circumstances
4.1 4.2 4.3		RFS RSC RFW	Flammable Solid Spontaneously Combustible Dangerous When Wet	Combustible, contributes to fire Ignites in contact with air ignites in contact with water	
5.1 5.2		ROX ROP	Oxidizer Organic Peroxide	Ignites combustibles on contact Reacts violently with other substances	Notify Fire Department Guard against fire Do not use water
6.1 6.2		RPB RIS	Toxic Infectious Substance	Harmful is swallowed, inhaled or in contact with skin Causes disease in humans and animals	Isolate area Obtain qualified assistance Do not touch Keep away minimum 25m
7 Cat I 7 Cat II/III		RRW RRY	Radioactive - White Radioactive -Yellow	Radiation hazard and harmful to death	
8		RCM	Corrosive	Hazardous to skin and metal	Notify Fire Department Guard against fire Avoid contact with skin
9		RSB MAG ICE RMD	Polymeric Beads Magnetized Material Dry Ice Miscellaneous	Involves small quantities of flammable gas Affects navigations system Causes sub cooling/suffocation Hazard not covered by other classes	Avoid contact with skin No immediate action required

 Volume II HLM	SPECIAL LOADS	3.3	Page 1
	SPECIAL CARGO	Ed 2 Rev 15/07 aug 25	

3.3 SPECIAL CARGO

3.3.1 LIVE ANIMAL (AVI)

The IATA Live Animals Regulations (LAR) have been approved by all IATA Member airlines and are now mandatory for the acceptance and air transportation of all species of live animals. The regulations include the requirement for shippers to provide a Shipper's Certificate.



- Cages containing live animals must be loaded into suitable aircraft compartments as identified by LIR and always tie-down to prevent shifting and falling.
- Cages should comply with the regulations as laid down in the IATA Manual for the transportation of live animals (LAR);
- Cages for pets must be made of rigid plastic and have:
 - side air vents in metal;
 - a metal door equipped with a locking system that secures the closing points located in the central, upper, and lower parts of the door;
- Cages must not be packed inside a closed Unit Load Device (ULD) with exception of fish.
- Avoid unnecessary tilting and jolting of containers. Animal containers must be handled and stowed in the upright position.
- Animals shall be loaded on board last and unloaded first, to minimize the waiting period on the ramp.
- Sufficient air space shall be left on the open side of the cage.
- Containers must not be loaded directly in front of or below air ventilation outlets so that there is sufficient air for normal breathing, the ventilation vents must not be blocked by other loads, compartments or ULD walls.
- Cats and dogs shall be loaded as close as possible to the compartment door easily accessible for watering and feeding at intermediate stations.
- The Captain must be advised of the species, location and quantity of all live cargo on board aircraft via NOTOC (see chapter 3.4 "NOTOC (SPECIAL LOAD NOTIFICATION TO CAPTAIN)").
- Live animals shall be loaded in accordance with table in paragraph 3.2.5.2 "Incompatibility between Dangerous Goods and Special Cargo".

 Volume II HLM	SPECIAL LOADS	3.3	Page 2
	SPECIAL CARGO	Ed 2 Rev 12/28 feb 25	

- Although live animal cages should be leak-proof they should be treated as "wet cargo"; the aircraft and other load must be protected against damage by flow-out of liquids and excrement by using plastic bowls, plastic sheets or rubber tarpaulins.
- Live animals should be loaded so that they do not affect the comfort of passengers and crew by their smell, noise or movements.
- Lights should be left on in the compartments where animals are carried.
- Animal which are natural enemies, e.g. cats and dogs, may be loaded in the same hold provided they are not in sight of one another.
- During transportation, loading and unloading, avoid exposing animals to extreme temperatures and draughts, especially at transit stops where the prevailing climatic conditions may be quite different from those of the place of origin of the animals.
- During transit operations, animal containers should be inspected; in case is noted apparent bad condition (or death) of animals, a supervisor shall immediately informed.

3.3.1.1 Quantity of live animals allowed on board Company aircraft

IATA "Live Animals Regulations" regulates the basic conditions for carriage of live animals on board of Company aircraft.

With respect to air transportation, live animals are divided in the following classes:

- **Class - A - amphibians.**
- **Class - B - birds.**
- **Class - C - shellfish.**
- **Class - F - fish.**
- **Class - I - invertebrates.**
- **Class - M - mammals.**
- **Class - R - reptiles**

Live animals will be accepted for carriage by air only in suitable containers as indicated on L.A.R. (Live Animals Regulations), either in ULDs or bulk. In both cases they must be loaded according to some basic rules:

- In case of multiple layers, containers on top must be compatible with the endurance of the containers underneath
- Compatibility with other cargo must be verified (see CM - Vol. III of the GOM)

The **maximum** quantity of live animals allowed on board, depending on their species and number and to the kind of ULD used, is:

- Kg 800 gross weight (including the cage) only for 88"x125" and 96"x125"pallets (PAG, PMC).
- Kg 250 gross weight only for 60.4"x61.4" pallets (PKC).

Note: The weight of class A-C-F-I-R animals can reach the maximum structural weight of pallets and/or aircraft compartments.

Note: Regulations for pets to be shipped in cabin or as baggage are defined in Chap 2.4 of PBM (Vol.I of GOM)

 Volume II HLM	SPECIAL LOADS	3.3	Page 3
	SPECIAL CARGO	Ed 2 Rev 15/07 aug 25	

3.3.1.2 Aircraft compartments suitability for transportation of live animals and maximum transportable loads

Aircraft	Compartment	Max gross weight (Kg) (*) (**)	Notes
A350	Compartments 1 - 2	Class A-C-F-I-R no limitation Class M Kg 270	Comp. 1-2 and 5 ventilated and heated
	Compartment 5	Class M Kg 90	
A332	Compartment 1 - 2	Class A-C-F-I-R no limitation Class M - B Kg 180	Comp. 1-2 and 5 ventilated and heated
	Compartment 5	Class A-C-F-I-R no limitation Class M - B Kg 200	
A339 (neo)	Compartment 1 - 2	Class A-C-F-I-R no limitation Class M - B Kg 235	Comp. 1-2 and 5 ventilated and heated
	Compartment 5	Class A-C-F-I-R no limitation Class M - B Kg 200	
A321 (neo)	Compartimento 1 -2	Class A-C-F-I-R nessuna limitazione Class C (*) Class M Kg 300 Class B Kg 250	Comp. 1-2 ventilated and heated
A320 A320 (neo)	Compartments 3 - 4	Class A-C-F-I-R no limitation Class C (*) Class M Kg 300 Class B Kg 250	Comp. 3-4-5 ventilated and heated Comp. 5: if Class M - B are embarked at the same time, the maximum weight must not exceed 200 Kg total.
	Compartment 5	Class A-C-F-I-R no limitation Class M Kg 300 Class B Kg 250	The cage with dimensions larger than 81x61x60 cm (31,9x24x23,6 inch) must be loaded through the door of Comp. 4
A319	Compartment 4	Class A-C-F-I-R no limitation Class C (*) Class M Kg 300 Class B Kg 250	Comp. 4-5 ventilated and heated. Comp. 5: se Class M - B are embarked at the same time, the maximum weight must not exceed 200 Kg total.
	Compartment 5	Class A-C-F-I-R no limitation Class M Kg 300 Class B Kg 250	
A220-300	Compartment 1	Class A-C-F-I-R no limitation Class M Kg 325	Hold 1 (A-B) ventilated and heated Loading of up to 3 cages is allowed In compartment A of the forward hold, only 1 cage weighing a maximum of 68 kg can be loaded.
A220-100	Compartment 1	Class A-C-F-I-R no limitation Class M Kg 225	Hold 1 (A-B) ventilated and heated Loading of up to 1 cage is allowed In compartment A of the forward hold, only 1 cage weighing a maximum of 68 kg can be loaded.
<p>(*) The maximum loadable gross weights include the cage or container of the animals.</p> <p>(**) If different classes of live animals are to be loaded in the same compartment, assume the maximum gross load value as the most restrictive data among those considered.</p>			

 Volume II HLM	SPECIAL LOADS	3.3	Page 4
	SPECIAL CARGO	Ed 2 Rev 12/28 feb 25	

3.3.1.3 Maximum dimensions for AVI cages

The cage shall be large enough for pet to stand, turn, sit and lie down in a natural position (without touching any side or the top of the container).

IATA provides specifications for determining standard cage dimensions:

- LENGTH = AVI length + AVI legs length;
- WIDTH = AVI width x 2;
- HEIGHT= AVI height + litter thickness.

MAXIMUM AVI CAGES DIMENSIONS					
Aircraft	Loading compartment	Maximum dimensions (cm)			Notes
		length	width	height	
A350	1 - 2	130	90	100	
	5	130	85	70	
A332	1 - 2	130	90	100	
A339 (neo)	5	130	85	56	
A321 (neo)	1 - 2	130	90	100	
A320	3 - 4	130	90	100	
A320 (neo)	5	130	90	100	The cage with dimensions larger than 81x61x60 cm must be loaded through the door of Comp. 4
A319	4	130	90	100	
	5	130	90	100	
A220-100	1	102	84	80	Loading of up to 1 cage is allowed
A220-300	1	102	84	80	Loading of up to 3 cages is allowed

Note: For the maximum quantities of live animals that can be transported in aircraft compartments, see paragraph 3.3.1.2 "Aircraft compartments suitability for transportation of live animals and maximum transportable loads"

 Volume II HLM	SPECIAL LOADS	3.3	Page 5
	SPECIAL CARGO	Ed 2 Rev 15/07 aug 25	

3.3.2 HUMAN REMAINS (HUM)

Transportation of human remains (**HUM**), except cremated (**HUC**) which are handled almost as normal cargo, is subject to the following conditions:

- Human remains must be contained in a hermetical sealed inner coffin of lead or zinc inside a wooden coffin.
- The wooden coffin must be protected by an outer packing or covered by canvas or tarpaulin.
- Whenever possible, loading/unloading operations should be carried out in absence of passengers.
- Any kind of funeral ceremony next to the aircraft is forbidden.
- Human remains shall be loaded in positions not adjacent to live animals (AVI) and foodstuffs (EAT).
- Human remains can be loaded inside ULD (container/pallet) if size allows, provided it is properly restrained. Human remains shall not be loaded inside the ULD with other deadload (baggage, cargo, mail).
- Whenever possible, according to weight & balance and space availability, passenger's baggage should be loaded in a separate compartment.
- The pilot-in command must be informed.

3.3.2.1 Loading for aircraft type

A330 / A350	<ul style="list-style-type: none"> • Avoid locating in hold 5, where the use of a loading belt is difficult and risky for this operation.
A321 neo / A320 / A320 neo/ A319	<ul style="list-style-type: none"> • Prioritize the transport of coffins on PKC pallets; bulk transport of coffins is permitted in case of emergency or lack of space in ULDs. • Small coffins can be loaded into AKH containers if properly positioned on euro-pallets. • Regardless of the loading method used, the coffins must be adequately secured.
A220	<ul style="list-style-type: none"> • It is possible to load on A223 up to 2 coffins, located one in hold 1 and one in hold 4, on A221 1 coffin properly restrained and secured.

Note: Cremated remains (HUC) must be shipped in funeral urns which are efficiently cushioned by suitable packaging

 Volume II HLM	SPECIAL LOADS	3.3	Page 6
	SPECIAL CARGO	Ed 2/20 apr 2022	

3.3.3 OVERHANG (OHG)

The dimensions of which (width and/or height) exceed those of the base pallet by a maximum of 50 cm per part may be palletized and restrained by a net, on condition that:

- a. The item loaded onto the pallet is not of such a size that it presents risks for the A/C when being loaded/unloaded.
- b. The dimensions of the load and its position on the pallet are such as to leave a space of at least 5 cm (2.0") on each side once on board.
- c. Adjacent pallets, onto which the load may overlap, must be contoured in such a way that the relative loads never touch and/or knock against each other.
- d. The inclination of the net is such that the angles formed with the plane of the pallet are never inferior to 30°; if necessary this should be obtained by using a stand (other cargo or planks or platforms) to lift the load in the appropriate way.

For practical reasons, the use of 5.000 lb. straps instead of the net is allowed as long as:

1. the above applicable conditions are respected;
2. the applicable safety factors and the proportionality factors relative to the inclination of the straps are considered.

3.3.4 EXTRA HEAVY/BIG LOADS (HEA/BIG)

A very heavy item on a small base produces a strong pressure on the bearing surface; this pressure, if it exceeds the structural resistance values of the bearing surface, may cause damage to the surface itself. In order to prevent this it is necessary to increase the base of the item by using planks or other appropriate devices in order to spread the weight.

Obviously, the strength of the material used for this purpose must be such that it can bear the weight of the load without sagging or bending.

3.3.4.1 Bulk/container load restraint

Bulk load must always be restrained according to the relative appropriate restraint factors where even one of the following conditions is present:

- a. the item weighs over 100 kg;
- b. the load is non-compressible (weight/volume ratio higher than 320 kg/m³);
- c. the item is of a shape which is potentially piercing;
- d. the load bears onto supports and/or planks for surface weight distributions;
- e. the hold (or the compartment, if divided by nets)/container is filled up to less than 80% of its volume.

 Volume II HLM	SPECIAL LOADS	3.3	Page 7
	SPECIAL CARGO	Ed 2 Rev 14/05 jun 25	

3.3.5 NO COMPRESSIBLE LOADS

Load with an average density inferior to 320 Kg/m³ is considered as compressible. Compressible load can act, in the case of an emergency, as a buffer for any no compressible load behind it. In case of insufficient compressible load, the no compressible load must be restrained by a forward restraint factor of 9 G.

3.3.6 PIERCING LOADS

Pipes, tubes, bars, beams, planks and similar pieces normally have a small cross section and might go through the meshes of the pallet nets or through the forward or aft compartment walls when loaded as single pieces or bundles. If such pieces are not secured properly, they can move and break through container or compartment walls and cause damage to the aircraft structure or other important parts. For this reason, they are considered piercing loads.

Such shipments shall be packed in a sufficiently strong crate.

Build up these shipments laterally (across the flight direction) if possible.

If pipes or bars exceptionally must be loaded in flight direction (for example because of their length) secure the pieces against forward and aft movements either by putting supporting platforms, planks or similar material vertically in front and aft of the pipes or bars. Fix the securing material to its position by enough tie-down straps. Ensure that enough tie-down straps for fixing the securing material to the pallet are used, according to the weight of the secured load.

3.3.7 CUTTING LOADS

Sheets and plates made out of metal or other dense material (e.g. granite, wood, fibreglass, rigid PVC, etc.) require a solid packaging when transported. Sharp edges can easily cut through pallet nets and tie down straps.

Shipment should not be accepted if any of the below mentioned conditions is not fulfilled:

- solid packing;
- all edges and corners must be completely covered by the packaging in order to provide suitable protection;
- packing must have adequate provision for the usage of forklifts.

 Volume II HLM	SPECIAL LOADS	3.3	Page 8
	SPECIAL CARGO	Ed 2/20 apr 2022	

3.3.8 PERISHABLE AND TEMPERATURE SENSITIVE HEALTHCARE

During transportation, loading and unloading of perishable and temperature sensitive healthcare, ensure they are:

- loaded on board last and unloaded first (if applicable), in order to minimize the waiting period on the ramp.
- not exposed to adverse environmental conditions, in order to follow the product's preservation indications.

3.3.9 SEGREGATION BETWEEN ACT - COL - CRT - ERT

When present ACT, COL, CRT and ERT products, segregation criterion for loading in the hold, contained in the following table, shall be applied:

AIRCRAFT LOADING COMPATIBILITY	ACT	COL	CRT	ERT
ACT	YES	YES	YES	YES
COL	YES	YES	NO	YES
CRT	YES	NO	YES	YES
ERT	YES	YES	YES	YES

ACT - Electrical active temperature control system or container (no specific temperature setting)

COL - Perishable requiring a temperature between +2 and +8 °C for transport and storage

CRT - Perishable requiring a temperature between +15 and +25 °C for transport and storage

ERT - Perishable requiring a temperature between +2 and +25 °C for transport and storage

Note: For COL, CRT and ERT products, when possible, indicate in the NOTOC the required temperature range.

 Volume II HLM	SPECIAL LOADS	3.3	Page 9
	SPECIAL CARGO		

3.3.10 VALUABLES/WEAPONS (VAL/WEA)

For the valuables is requested:

- A. Storage in the safe during the acceptance, transit and arrival phase.
- B. Security airport service during the transport from the warehouse to the aircraft and vice versa.
- C. The vigilance service until the a/c holds are closed and when the holds are open.

For weapons:

- A. During the acceptance, weapons are to be delivered unloaded and ammunition separated from firearms.
- B. Storage in the safe during the acceptance, transit and arrival phase.
- C. Security airport service during the transport from the warehouse to the aircraft and vice versa.
- D. Vigilance service until the a/c holds are closed and when the holds are open.
- E. Stowe in the aircraft in a place inaccessible to passengers during flight.
- F. According to AIR/OPS the transport of weapons and/or ammunition must be indicated in the NOTOC under the OTHER SPECIAL CARGO section.

 Volume II HLM	SPECIAL LOADS	3.4	Page 1
	NOTOC (SPECIAL LOAD NOTIFICATION TO CAPTAIN)	Ed 2 Rev 17/27 jan 26	

3.4 NOTOC (SPECIAL LOAD NOTIFICATION TO CAPTAIN)

All Dangerous Goods (except some substances listed in Chap. 3.4.2 from which the notification is optional) and some Special Cargo shipments listed in Chap. 3.4.1, shall be always notified to Captain using the NOTOC.

The NOTOC form could be both manual or electronic format.

- NOTOC must be issued every time that Dangerous Goods are loaded on Company flights (originating and/or in transit)
- NOTOC must be filled in duplicate or even more copies (should local needs require it).
- Compilation of the form must be carried out by Cargo personnel following instructions given on the Shipper Declaration.
- Department responsible to fill in NOTOC shall forward a copy to Load Control department, in order to allowed Load Controller to plan the shipment distribution
- Field "Final Load" shall be filled in by the "Loading Supervisor" who's also responsible to:
 1. give the necessary instructions to staff so that loading is completed according to requirements;
 2. check that loading is carried out correctly, intervening if necessary;
 3. stop embarkation and immediately inform the responsible Department where inconsistencies are detected in the documentation, or shipment is damaged;
 4. record any changes made from original instructions, whether requested by the Load Controller or in any other cases where necessary (in the latter instance the Load Controller must be immediately informed);
 5. Sign two copies of the form and distribute them as follows:
 - 1° copy: to be delivered to the aircraft Captain for flight documentation. This copy may be checked, if needed, by the next stations.
 - 2° copy: to be returned to the Weight and Balance Department signed by the Captain. This copy must be kept on file by the Station, and filed as per Company policy.

Should transit stations change the position and/or entity of dangerous goods on board the aircraft, Captain must be notified about the change by issuing a new form (in two copies).

Note: In case of Dangerous Goods transported under a State exemption, such information shall be reported in field "Other Information" for manual NOTOC, "Supplementary Information" for EDP NOTOC.

 Volume II HLM	SPECIAL LOADS	3.4	Page 2
	NOTOC (SPECIAL LOAD NOTIFICATION TO CAPTAIN)	Ed 2 Rev 17/27 jan 26	

3.4.1 MANDATORY NOTOC FOR SPECIAL CARGO SHIPMENT

Cargo GHA must report on the NOTOC (manual or EDP) “other special load” box number of pieces and weight of all special cargo types listed in the following table:

IMP CODE	DESCRIPTION
AVI	Live animals
COL	Perishable requiring a temperature between +2 and +8 °C for transport and storage
CRT	Perishable requiring a temperature between +15 and +25°C for transport and storage
EAT	Foodstuffs for human consumption other than meat and fish/seafood
ELI	Lithium Ion batteries excepted
ELM	Lithium Metal batteries excepted
HEG	Hatching eggs
HUM	Human remains in coffins
LHO	Live human organs/blood
MAG	Magnetized material
PEF	Perishable: cut flowers
PEM	Perishable: meat
PEP	Perishable: fruits and vegetables
PER	Perishables: other than PEF, PEM, PEP, PES or EAT
PES	Perishable: seafood/fish
VAL	Valuable cargo
WBD	Dry Battery Wheelchair
WBL	Lithium Battery Wheelchair
WBW	Wet Battery Wheelchair
WBX	Removable Lithium Battery Wheelchair
WEA	Weapons
WET	Shipments of wet materials not placed in watertight containers, i.e. fish packed in wet ice

Note: Live Animal (PETC) / Weapons (ARMD and WEAP) checked-in by passengers area and Live Human Organs (LHO) not accepted by cargo department do not need to be notified on the NOTOC.

3.4.2 NO MANDATORY NOTOC FOR DANGEROUS GOODS SHIPMENT

Substances and articles that do not require to appear on the NOTOC are published in table 9.5.A of the IATA Dangerous Goods Regulations; a Company exception requires evidence on the NOTOC for the following substance even if shown on the table:

- Magnetic material (MAG).

3.4.2.1 Example of EDP NOTOC

1	SPECIAL LOAD		NOTIFICATION TO CAPTAIN				PREPARED BY a ← →					
2	FROM	FLIGHT	DATE			A/C REG						
3	aaa	mmafffa/ff	ffaaaff			m ← →						
4	DANGEROUS GOODS											
5	TO	AWB NR	CL/DV	UN/ID	SUB	PCS	QTY/TI	RRR	PCK	IMP	CAO	POS
5a			COMP	NR	RSK			CAT	GRP	CODE		ULD CODE
6	ff.t	← →										t
6a	t	← →										t
7	aaa	f ← → f	tttt	aa	ttt/	fff	t ← → t	aaa	aaa	aaa/	aaa	mmm
7a			ffff	ttt				aaa	aaa	aaa	m ← →	m
8	OTHER SPECIAL LOAD											
9	TO	AWB NR	CONTENTS				PCS	QTY	IMP	POS		
9a									CODE	ULD CODE		
10	ff.aaa	f ← → f	t ← → t				fff	ffff	aaa	mmm		
10a									m ← →	m		
11	SI	← →										t
11a	t	← →										t
12	THERE IS NO EVIDENCE THAT ANY DAMAGED OR LEAKING PACKAGES											
12a	CONTAINING DANGEROUS GOODS HAVE BEEN LOADED ON THE AIRCRAFT											
13	LOADING SUPERVISOR'S SIGNATURE						CAPTAIN'S SIGNATURE					

Note: Lines 6, 6a, 7, 7a, 10, 10a, 11 and 11a to be repeated as needed.

3.4.2.2 Example of Manual NOTOC

SPECIAL LOAD — NOTIFICATION TO CAPTAIN														
Station of Loading (1)		Flight Number (2)		Date (3)		Aircraft Registration (4)		Prepared by (5)						
DANGEROUS GOODS														
Station of Unloading (6)	Air Waybill Number (7)	Proper Shipping Name (8)			Class or Division For Class 1 compat. gms. (9)	UN or ID Number (10)	Sub Risk (11)	Number of Packages (12)	Net quantity or Transp. Incl. per package (13)	Radio-active Mat. Categ. (14)	Packing Group (15)	Code (see reverse) (16)	CAO (X) (17)	Loaded
													ULD ID (18)	POSITION
(23) * There is no evidence that any damaged or leaking packages containing dangerous goods have been loaded on the aircraft.														
OTHER SPECIAL LOAD (19)														
Stat. of Unloading	Air Waybill Number	Contents and Description				Number of Packages	Quantity	Supplementary Information			Code (see reverse)	Loaded		
											ULD ID	POSITION		
Loading Supervisor's Signature (20)		Captain's Signature (21)			Other Information (22)									

 Volume II HLM	SPECIAL LOADS	3.4	Page 4
	NOTOC (SPECIAL LOAD NOTIFICATION TO CAPTAIN)	Ed 2/20 apr 2022	

3.4.2.3 Manual NOTOC Filling Instruction

Nr	Field	Explanation
1	Station of Loading	Three IATA letter code of the station where loading is carried out
2	Flight Number	Flight identifier
3	Date	Date of issue of the form
4	Aircraft Registration	Aircraft registration marks
5	Prepared by	Completion the person or office preparing the NOTOC prior to its release to weight and balance office
6	Station of Unloading	Three IATA letter code of the station of Unloading
7	Air Waybill Number	Number of the air transport letter.
8	Proper Shipping Name	Full Name as per Shipper Declaration
9	Class or Division	For class 1, compatibility group
10	UN or ID Number	Name of article as per Shipper Declaration
11	Subsidiary Risk	Completion as per Shipper Declaration
12	Number of Packages	Number of Packages
13	Net Quantity or Transport Index per package	Net quantity per package in Kilograms or litres. For RRY (yellow label) enter the transport index per package (e.g. TI 5.6)
14	Radioactive Category	Enter I, II or III according to the label of the package
15	Packing Group	Completion as per Shipper Declaration
16	Code	Standard three letter code that identifies the type of dangerous goods IMP Code (e.g. RFL)
17	CAO	Enter with "X" for cargo aircraft only items
18	Loading Position	Enter the loading position in the POS column. Additionally the ULD identification (ULD code) may be entered in ULD ID column
19	Other Special Load	To be used for special goods indicated in Chap. 3.4.1
20	Loading Supervisor Signature	Loading Supervisor Signature
21	Captain's Signature	Captain's Signature
22	Other Information	Self explanatory (Note: confirmation that there is no evidence of damage or leakage from packages containing dangerous goods loaded on the aircraft shall be reported in this field).

 Volume II HLM	SPECIAL LOADS	3.4	Page 5
	NOTOC (SPECIAL LOAD NOTIFICATION TO CAPTAIN)	Ed 2/20 apr 2022	

Note: Temperature selection in cargo compartments.

If the Cargo General Sales Agent (GSA) of a flight or the station (cargo or passengers) requests a particular temperature in a given cargo compartment, this request must be transmitted to the operator in charge of compilation of the Loadsheets, who shall insert the appropriate code in the "NOTES 2" box, depending on the case, composed by indication T, by the number of the compartment concerned and by a bar followed by the requested temperature expressed in C°. If the above mentioned box is not included in the Loadsheets (non-ITA forms or automatically issued Loadsheets), the code should be added at the bottom right of the form. If no specific temperature is requested it is not necessary to write any relative indication on the Loadsheets.

WEIGHT AND BALANCE

 Volume II HLM	WEIGHT & BALANCE	4.1	Page 1
	GENERAL	Ed 2/20 apr 2022	

4.1 GENERAL

4.1.1 INTRODUCTION

The use of documents linked to aircraft loading operations has a direct impact on the accuracy of information transmitted/shared between operational staff (crew, cargo department, handling staff, etc.). Moreover some information included in these documents is directly related to aircraft safety. To avoid any risk of misunderstanding or mistakes it is mandatory to check the reference and validity of any document before it will be used and/or transmitted. Loading documents for weight & balance includes:

- **Weight & Balance data**
- **Loading Instructions Report (LIR) either manual and EDP**
- **Balance Chart (BC)**
- **Loadsheets either manual and EDP**

4.1.2 PURPOSE AND SCOPE

Regardless the type of organisation and the actors involved in flight handling, and whatever the circumstances are, for each flight the following must be ensured:

- flight safety,
- a good quality of the stowage of the load in the aircraft compartments taking into account handling quality, punctuality and the requirements of next station(s),
- the most economical utilisation of the aircraft capacities.

 Volume II HLM	WEIGHT & BALANCE	4.1	Page 2
	GENERAL	Ed 2/20 apr 2022	

4.1.3 FUNCTION AND RESPONSIBILITY

To deal with the above safety requirements, a station organisation must ensure the following functions:

- Load Control Function (Load Controller)
- Loading/Unloading Supervision Function (Loading/Unloading Supervisor)
- Loading Function (Loading Team)

Name and/or (even electronic) signature of each agent performing one of the functions described above shall appear on the corresponding document. By signing the document the agent takes responsibility for the tasks and checks he/she performed.

Any incident regarding load control and/or loading activities must be reported as per Company policy and module GSR (see GOM - Introduction - 0.0).

All the functions must be performed by trained and qualified agents.

The training for the different functions shall include:

- DG basic course (training as per job role) with recurrent training within 24 months.
- basic course according to the specific role (i.e. Load Controller) performed with recurrent training within 36 months.

Load Controller shall maintain good knowledge of manual weight & balance, by elaborating an adequate number of exercises, 1 every 2 months, a total of at least 6 exercises per year.

Exercises shall involve all kinds of ITA aircraft operating on the relevant station and shall be verified and corrected by a supervisor, in order to report eventual mistakes. ITA station manager is responsible to verify periodically with the handling Company if exercises are regularly carried out by all load controllers who handle ITA flights. Exercises shall be filed for at least one year and made available in case of station audit.

 Volume II HLM	WEIGHT & BALANCE	4.1	Page 3
	GENERAL	Ed 2 Rev 16/04 sep 25	

4.1.3.1 Load Control Function

Load Control is responsible to ensure that:

- Aircraft DOW/DOI is verified and correct.
- The aircraft weight and balance limitations are complied with.
- If for particular local restriction or in any other circumstances the Company does not accept cargo, mail or stores for consumption for transport such items are prevented from being loaded into any aircraft.
- Dangerous Goods and other special loads are disseminated and segregated, in accordance with the Company regulations, following the instructions for each aircraft type.
- The information on the Loadsheet reflects the actual loading of the aircraft.
- Any verbal exchange of load information or data that could affect weight and balance calculation is manually or electrically documented.

4.1.3.1.1 Load planning

Objective:

- settle on the most efficient distribution of the load planned to be available and to maximise the utilisation of the available cargo capacity, with due regard to quality and punctuality,
- issuance of a Loading Instruction / Report (LIR),
- check of provisional weight and balance limitations,
- preparation of the Loadsheet.

Tasks:

1. Collection and interpretation of various data concerning the aircraft loading:
 - operational weights,
 - fuel density and figures,
 - predicted passenger's data, provisional cabin distribution,
 - predicted baggage data,
 - cargo and mail statement (manual or computerised),
 - airline equipment (EIC, AOG, FKT, etc).
2. EZFW calculation.
3. Provisional NOTOC.
4. Load messages (LDM, CPM) received from previous station (transit/arrival station).
5. Operational limited weights, when applicable (i.e. runway limitation etc.).
6. Issuance of LIR and NOTOC (if applicable) based on the above mentioned collected data.

Note: For A319,A320,A320 neo and 321 neo aircraft: when possible, pyramidal loading is suggested positioning highest weights (uld or loose) close to the central wing structure, aft in the fwd hold, fwd in the aft hold.

 Volume II HLM	WEIGHT & BALANCE	4.1	Page 4
	GENERAL	Ed 2 Rev 2/26 jan 23	

4.1.3.1.2 Loadsheets and Messages

Objective:

- issue of the Load Sheet against information affecting the load and its location, as provided and checked by the responsible agents as: Loading Supervisor, Passenger Services, Crew and the Maintenance Department,
- forward, before flight departure, the updated NOTOC (on which the captain's signature is not necessary), to Flight Dispatch/OCC addressed to coordinatorifd@ita-airways.com and to the concerned ITA Station Manager of the first landing station,
- forward of the load messages LDM, CPM, MVT.

Tasks:

1. Checking the Load Sheet figures against:
 - Final Loading Report from the Loading Supervisor.
 - Actual passengers data:
 - number of passengers on board,
 - passenger type (adults, children, infants),
 - seating distribution on board,
 - person travelling on crew seat (including supernumeraries).
2. Baggage weight (including hold baggage that exceeds normal allowances and gate delivery items), cargo and mail.
3. Any non-normal load item.
4. Fuel figures, confirmed by the Captain:
 - Block, Taxi and Trip Fuel,
 - fuel distribution if non-standard.

Note: The Captain remains responsible for the total fuel quantity on board. By accepting the Loadsheets, he takes responsibility for the total fuel quantity on board including Block, Trip and Taxi Fuel and the weights mentioned on the Loadsheets.

5. Confirming with name and signature (manual or electronic) that information displayed on the Final Loadsheets is accurate and in accordance with the applicable loading procedures.

 Volume II HLM	WEIGHT & BALANCE	4.1	Page 5
	GENERAL	Ed 2 Rev 17/27 jan 26	

4.1.3.2 Loading/Unloading Supervision Function

Objective:

- If for particular local restriction or in any other circumstances the Company does not accept cargo, mail or stores for consumption for transport such items are prevented from being loaded into any aircraft.
- Actual loading supervision of holds, in compliance with the loading instructions, including modifications made during the handling, agreed by the Load Controller and shown on the report box.
- Insuring ground stability by complying with loading/offloading sequences, when applicable.

Note: The Loading/Unloading Supervisor, at the stations where the Company's DCS is present, uses Altea FM Mobile (an extension of the Altea FM system) for the completion of loading. Altea FM Mobile allows, through the use of a tablet, the electronic transfer of data to the Load Controller for the completion of the Loadsheets.

Tasks:

1. Checking the offloading of incoming flight (arrival/transit) on the basis of LDM/CPM and ensure ULDs are inspected to identify damage and to determine airworthiness.
2. Informing the Load Planner before loading, if the physical registration of the aircraft is not consistent with the registration on the LIR.
3. Before loading, briefing Ground Staff involved in loading operations about load to be offloaded or repositioned (transit) on arrival, transmission of the departure Loading Instructions Report received from the Load Controller and, if necessary, explanation about specific instructions.
4. Checking before loading that cargo compartments are empty.
5. Reporting to the Captain or Maintenance Department and Load Planner about any hold inoperative, missing and/or damaged restraints not previously highlighted.
6. Checking ULDs:
 - type, ID number, commodity, weight (if applicable), number of pieces (if applicable) and destination are consistent with the LIR.
 - forwarded to the aircraft are serviceable and airworthy (door closed, pallet nets well tightened, pallet load stability ensured, straps well positioned, no FOD, no water or snow accumulation on ULD, etc.).
7. Checking the apparent condition of special load, including dangerous goods, presented for bulk loading and those loaded on ULDs, visible from the outside.
8. Refusal of items which do not comply with loading requirements (leakage or damage) and, when concerned, application of the local emergency instructions.
9. Communicate/transmit the final fuel data to the Load Controller.
10. Confirming with name and signature on the NOTOC (if any) that mandatory checks on special load including dangerous goods (i.e. the UN number on the NOTOC matches the shipment label) have been carried out before loading and that positioning shown on the NOTOC corresponds to the actual loading.
11. Delivery to the cockpit crew of the NOTOC (if any) received from the Cargo Department or Load Controller.
12. Document any load information or data on LIR.
13. Once the loading is completed and before departure, confirming the final aircraft loading information and data (for local and transit load) to the Load Controller for the issuance of the final load documents.

 Volume II HLM	WEIGHT & BALANCE	4.1	Page 6
	GENERAL	Ed 2 Rev 17/27 jan 26	

14. Transmission of the Last Minute Changes (if any) to the Load Controller.
15. Cross check information between final Loadsheet and LIR (not applicable with EDP ACARS Loadsheet).
16. Ensuring LIR is countersigned by Captain and collect all necessary documents for filing (see Chap. 4.5 FLIGHT DOCUMENTATION COLLECTION AND FILING).



Caution:

1. Before loading: briefing of agent in charge of Loading Function.
2. During loading: intermediate checks.
3. End of loading: retrieving the Loading Report (LIR) and sign.

4.1.3.3 Aircraft Loading Function

Objective:

- physically loading/offloading of the holds.

Tasks:

1. Positioning and removing of loading equipment.
2. Offloading of the incoming aircraft.
3. Informing the Loading Supervisor about any abnormality concerning hold equipment and/or damaged aircraft structure (ceiling, partition, floor, load restraint system).
4. Loading of ULDs and bulk load according to the LIR, including special requirements (load spreading, tie down, load segregation, etc.) and/or instructions given by the Loading Supervisor.
5. Setting and control of the load restrains (locks, nets).
6. Reporting of the actual loading to the Loading Supervisor.

 Volume II HLM	WEIGHT & BALANCE	4.2	Page 1
	LOAD PLANNING	Ed 2/20 apr 2022	

4.2 LOAD PLANNING

4.2.1 ESTIMATED ZERO FUEL WEIGHT (EZFW) CALCULATION

The estimated zero fuel weight, EZFW must be calculated by adding the following data:

1	Dry Operating Weight (DOW)
2	Any corrections to DOW
3	Passenger weight
4	Baggage weight
5	Cargo / mail weight
6	ULD tare weight

1. DOW shall be calculated as follows:
 - conventional aircraft weight
 - plus (+) adjustments for each aircraft (see current version of “Mass & Balance Data Sheet”)
 - plus (+) pantry weight standard for lines or specific legs (see current version of “Mass & Balance Data Sheet”)
 - plus (+) crew (flight deck crew plus (+) flight attendants)
2. Any correction to DOW includes:
 - additional crew
 - extra spare parts (FKT-EIC)
 - extra pantry
 - fuel as ballast
3. Passenger weight include:
 - booked passengers
 - passengers on the waiting list
4. Baggage weight shall be calculated according to Company requirements. Below the table of average baggage pieces per passenger and destination in use for ITA (determine the number of baggages by multiplying the passenger number to the average number of baggages per passenger:

Italy	0.8
Europe	1.1
Mediterranean	1.3
Asia and Oceania	1.4
North America	1.4
South America	1.5
Africa	1.4

 Volume II HLM	WEIGHT & BALANCE	4.2	Page 2
	LOAD PLANNING	Ed 2 Rev 6/15 nov 2023	

5. Cargo/Mail weight
 cargo and mail weight shall be calculated by collecting information from relevant Cargo and Mail department, using the provisional figures.

6. ULD tare weight
 ULD tare weight shall be calculated as per Cap. 4.2.6 ULD TARE CALCULATION, the number of ULD planned shall reflect the baggage and cargo/mail preliminary figures calculated as per points 4 and 5.

4.2.1.1 Communication in case of EZFW variation

When the Load Controllers realize or are informed that there is variation to the commercial load, increasing or reducing the expected Zero Fuel Weight (ZFW), because of operational circumstances as: rerouting or cancelling transit passengers and bags or cargo and mail or go/no show passengers, etc., they must immediately inform via e-mail or telex to ITA Flight Dispatch if one if the below mentioned values are applicable.

DEVIATION ESTIMATED ZERO FUEL WEIGHT		
Aircraft	Lower ZFW (Kg)	Higher ZFW (Kg)
A330 - A350	- 3000	+ 3000
A321 - A320 - A319 - A220	- 3000	+ 3000

Note: When the procedure “Just In Time Refuelling” is applicable, all data of AZFW data is automatically received from Flight Dispatch. the communication from Load Control is not necessary.

 ITA AIRWAYS Volume II HLM	WEIGHT & BALANCE	4.2	Page 3
	LOAD PLANNING	Ed 2/20 apr 2022	

4.2.2 OPERATING CREW WEIGHT CALCULATION

On loading and weight and balance documents, operating crew weight, shall be worked out on the basis of the Company standards. Following standard unit values are valid for ITA:

	Weight (Kg)
FLIGHT CREW	85
CABIN CREW	75

Note: The above weights:

- include hand baggage weight;
- do not include the baggage weight loaded in aircraft hold.

The total weight of the operating crew is included in DOW.

 Volume II HLM	WEIGHT & BALANCE	4.2	Page 4
	LOAD PLANNING	Ed 2 Rev 3/26 may 23	

4.2.3 OPERATING CREW BAGGAGE WEIGHT CALCULATION

Note:

In the stations where MUST GO crew members are allowed to carry their baggage directly on the stand (see Vol. I - PBM), their baggage shall be handled in the same way as the operating crew baggage, as described below.

The operating crew baggage quantity loaded in the hold and their position in the cargo compartments shall be reported on the LIR (Loading Instruction Report) by the Loading Supervisor and transmitted to the Load Controller.

The Load Controller shall manually value each operating crew baggage loaded in the hold on the Loadsheets using the following standard weights:

Type of flight	Weight (Kg)
Domestic (flight with origin and destination within the borders of one State)	11
Within the European region (flight, other than Domestic flight, whose origin and destination are within the area specified in Fig.1 and Note 1 of Chap. 4.2.5)	13
Intercontinental (flight, other than flight within the European region, with origin and destination in different continents)	15
Intercontinental Holiday Charter	15
All other	13

The weight of each crew baggage loaded in the hold shall not be included in DOW (DRY OPERATING WEIGHT), but inserted in the Loadsheets as DEAD LOAD.

The Load Controller shall insert a note (i.e. "CREW BAGS LDD IN H5") so that it appears on the Loadsheets. If using the DCS, the note shall be entered in the SI field of the LDM.

For operating crew baggage, the standard stowage and loading code (to be used on documents and traffic messages) is described in Chapter 9.2.

4.2.4 PASSENGER WEIGHT CALCULATION

On loading and weight and balance documents, passenger weight shall be worked out on the basis of the Company standards. Following standard unit values are valid for ITA Airways:

Category	Standard Weight (Kg)			
	SCHEDULED FLIGHTS	SPECIAL CHARTER FLIGHTS	HOLIDAY CHARTER FLIGHTS	FLIGHTS TO/FROM JAPAN
ALL ADULTS	84	84	76	73
ADULT MALE	88	88	83	81
ADULT FEMALE	70	70	69	63
CHILD	35	35	35	35
INFANT	0	0	0	0
All weights include hand baggage weight				

Note: A passenger is considered:

- ADULT from the day of his/her twelfth birthday;
- CHILD from the day of his/her second birthday to that before his/her twelfth birthday;
- INFANT up to the day before their second birthday.

On loading and balance documentation concerning scheduled flights operated by ITA Airways, passenger weight must be calculated through ADULT MALE/FEMALE unit value.

ALL ADULTS, for ITA passenger weight must be applied for the following events:

1. In case the operating DCS system, for weight & balance, is unable to apply the ADULT MALE / FEMALE passenger weight unit value.
2. Every time the Load Sheet is performed manually.
3. For each Charter (Special / Holiday).
4. For each Free Seating flight.

Note: For passengers checked on jump seat, the unit value to be applied must be the same of the other passengers on the flight.

 Volume II HLM	WEIGHT & BALANCE	4.2	Page 6
	LOAD PLANNING	Ed 2 Rev 17/27 jan 26	

4.2.4.1 Non standard passengers on scheduled and charter flights

In the event of a group of passengers (from 10 people) being obviously above average standard weight (i.e. sport teams such as basket or rugby, teams of weightlifters, overweight persons club, etc.) or below average standard weight (i.e. teenagers in the 12-15 years bracket accounted for adults), it is mandatory to apply corrections on the final weight and balance figures of the flight based on estimated passenger weight.

The passenger handling department is responsible for informing the Load Controller.

The non-standard passenger data are entered by the agent in charge of the flight loading control.

a. Manual Loadsheets

The weight gap is taken into account in both cases, above and below the average standard weight.

Example "heavier than the standard weight"

15 sports players (estimated weight 100 Kg each).

Calculate the equivalent number of passenger with a standard weight (84 kg):

$15 \times 100 \text{ Kg} / 84 \text{ Kg} = 18$ "standard" passengers.

The difference is 18 estimated passengers minus 15 actual passengers = più 3 pax.

The actual payload is increased by $84 \text{ Kg} \times 3 = 252 \text{ Kg}$.

Example "less than the standard weight"

A320, group of 30 teenagers (estimated weight 50 Kg each), seated in zone 0C.

Calculate the equivalent number of passenger with a standard weight (84 Kg):

$30 \times 50 \text{ Kg} / 84 \text{ Kg} = 18$ "standard" passengers.

The difference is 18 estimated passengers minus 30 actual passengers = minus 12 pax in 0C zone.

The actual payload is decreased by $84 \text{ Kg} \times 12 = 1008 \text{ Kg}$.

b. Local EDP Loadsheets

The local Load Control will update the Loadsheets (DCS FM/Non-Standard Weight Passengers) after receiving the final non-standard passenger data from the passenger area, within -15 of ETD.

c. Remote Loadsheets

The CLC (see 4.3.6) will update the Loadsheets after receiving the final non-standard passenger data within -15 of ETD from:

- in the case of the CLC DCS procedure, the Loading/Unloading Supervisor via the Altea FM Mobile chat;
- in the case of the CLC LDS procedure, the Station CLC Coordinator by filling in the notes field on the LDS form.

 ITA AIRWAYS Volume II HLM	WEIGHT & BALANCE	4.2	Page 7
	LOAD PLANNING	Ed 2/20 apr 2022	

4.2.5 REGISTERED BAGGAGE WEIGHT PLANNING AND CALCULATION

Baggage should usually be loaded in a manner that allowed a quick offloading at destination. According to different baggage types a segregation shall be managed as per company policy (see Chap. 9.2 BAGGAGE ASSISTANCE).

For manual load planning purpose, baggage weight shall be calculated according to Company requirements.

Registered baggage weight shall always be calculated on the Loadsheet on the basis of the actual weight.

Whenever the actual weight cannot be used due to infrastructures or other constraints, Company standard weights shall be used. The table below is valid for ITA Airways:

Type of flight	Weight (Kg)
Domestic (flight with origin and destination within the borders of one State)	11
Within the European region (flight, other than Domestic flight, whose origin and destination are within the area specified in Fig. 1 e Note 1)	13
Intercontinental (flight, other than flight within the European region, with origin and destination in different continents)	24
Intercontinental Holiday Charter	20
All other	13

Note:

Whenever hand luggage needs to be collected on ITA Airways flight in order to be loaded in hold, during passenger boarding, the standard weight must be considered 8 Kg.

The Loadsheet shall be updated with weight and index adjustments relating to baggage added in this way.

 Volume II HLM	WEIGHT & BALANCE	4.2	Page 8
	LOAD PLANNING	Ed 2/20 apr 2022	

Fig.1



Legend:

Albania, Algeria, Armenia, Austria, Azerbaijan, Belarus, Belgium, Bosnia Herzegovina, Bulgaria, Croatia, Cyprus, Czech Republic, Denmark, Egypt, Estonia, Finland, France, Georgia, Germany, Greece, Hungary, Ireland, Israel, Italy, Jordan, Kosovo, Latvia, Lebanon, Libya, Lithuania, Luxembourg, Macedonia, Malta, Moldova, Morocco, Netherlands, Norway, Poland, Portugal, Romania, Russia, Serbia & Montenegro, Slovak Republic, Slovenia, Spain & Canary Islands, Sweden, Switzerland, Syria, Tunisia, Turkey, Ukraine, United Kingdom.

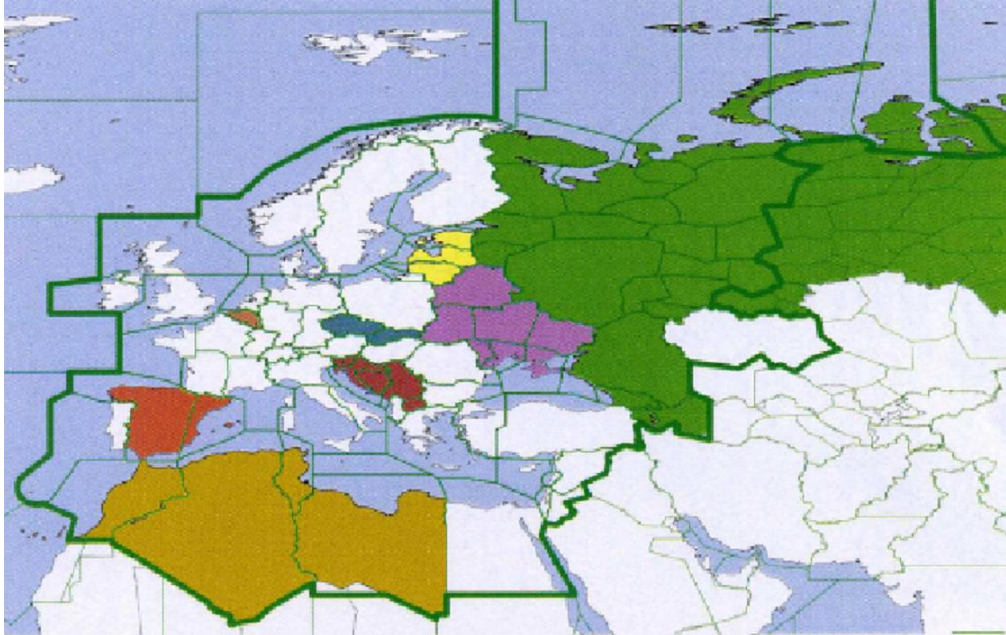
- a. For security reasons, the number of baggage items actually loaded per destination must be entered in the "Notes 1" box of the Loadsheel
- b. In the event of "expedite/rush" baggage being loaded, it should:
 - be entered on the Loadsheel on the basis of actual or standard weight, depending on procedure
 - be highlighted in the "Notes 1" box of the Loadsheel
- c. The number baggage items loaded must correspond to the number of baggage items checked-in: should this not be the case then the reason for the discrepancy must be verified.

 Volume II HLM	WEIGHT & BALANCE	4.2	Page 9
	LOAD PLANNING	Ed 2 Rev 17/27 jan 26	

4.2.6 ULD TARE CALCULATION

On load and weight and balance documents, the ULD tare shall be calculated, according to the following standard values:

ULD type	Owner	DCS codes	Base dimensions (inch)	Height (inch)	Tare weight (Kg)	Maximum net weight (Kg)	Notes
Container AAP	ITA	AAP	88x125	64	211	4415	
Container ALF	Etihad (EY)	ALF	60.4x125	64	152	3023	
Container AKE	ITA	AKE	60.4x61.5	64	80	1507	
Container AKE	ITA	AKL	60.4x61.5	64	63	1524	Container made of composite material
Container AKH	ITA	AKH	60.4x61.5	45	82	1052	
Container AMP	ITA	AMP	96x125	64	344	4758	
Container RKN	CSafe (7K)	RK1	60.4x61.5	64	646	941	Container powered by battery, no dry ice
	Envirotainer (PC)						
Container RKN	Envirotainer (PC)	RK2	60.4x61.5	64	265	1322	Container cooled by dry ice
Container RKN	DoKaSch (3D)	RK3	60.4x61.5	64	470	1117	Container powered by battery, no dry ice
Container RLP	Envirotainer (PC)	RLP	60.4x125	64	880	2295	Container powered by battery, no dry ice
Container RAP	Envirotainer (PC)	RA1	88x125	64	450	4176	Container cooled by dry ice
Container RAP	Envirotainer (PC)	RA2	88x125	64	1100	3526	Container powered by battery, no dry ice
	DoKaSch (3D)						
Container RAP	CSafe (7K)	RA3	88x125	64	1213	3413	Container powered by battery, no dry ice
Pallet PAG	ITA	PAG	88x125	64	113	4513	
Pallet PLA	ITA	PLA	60.4x125	64	84/124	3051	
Pallet PKC	ITA	PKC	60.4x61.5	45/64	40	1094	
Pallet PLW	LH	PLW	60.4x125	64	154	3051	Pallet with side extensions
Pallet PMC	ITA	PMC	96x125	64	124	4978	

 Volume II HLM	WEIGHT & BALANCE		4.2	Page 10
	LOAD PLANNING			Ed 2 Rev 17/27 jan 26

Pallet PMC	ITA	PML	96x125	64	99	5003	
---------------	-----	-----	--------	----	----	------	--

The actual ULD tare may be used for special operational/traffic needs or the request of the local authorities.

Note: Pallets is ULD consisting of a loading platform and restraint net.

4.2.7 SPECIAL FLIGHT KIT WEIGHT CALCULATION (SFK)

In some cases may be necessary to load Flight Kit (spare parts) when operating on specific destination.

If it is necessary to load a Flight Kit, a telex from Maintenance Department is issued reporting number and weight of spare parts to be loaded.

Below are shown the weights of Flight Kit as per fleet type, if a discrepancy is noted between the weights of the table and the weights of the telex, the latter one shall be used.

AIRCRAFT TYPE	SFK COMPLETE		SFK TOOL		SFK MINI	
	ULD Type	Net Weight (Kg)	ULD Type	Net Weight (Kg)	ULD Type	Net Weight (Kg)
A330 - A350	1 AAP	808	N/D		1 AKE	430
A321 - A320 - A319	2 AKH	350 290	1 AKH	350	1 AKH	290
A220*	-	-	-	-	69	-

*SFK of 69kg. is located in **Forward Cargo Compartment 1 - Section B**, the weight must be added manually by the Load controller on the DeadLoad Screen.

SFK shall never be offloaded, in the "SI" field type "not to be disembarked".

4.2.8 OPTIMIZED CG (Centre of Gravity)

The aircraft Center of Gravity (CG) directly affects fuel consumption, which are reduced proportionally while retreating (Nose Up).

 Volume II HLM	WEIGHT & BALANCE	4.2	Page 11
	LOAD PLANNING	Ed 2 Rev 15/07 aug 25	

4.2.9 TIPPING PREVENTION

During the loading/unloading of the holds and the embarking/disembarking of the passengers, the Centre of Gravity (CG) of the aircraft can vary considerably and, if the position assumed is backward compared to the main gear, it is possible that the conditions for lifting the front of the aircraft from the ground, can occur (generally known as "static tipping").

Below is a sample of some factors and/or conditions that could affect the stability of the aircraft:

- a. low aircraft weight combined with aft Centre of Gravity;
- b. non-standard fuel distribution, low fuel load or full main tanks with empty centre tank;
- c. surface inclination of the parking area;
- d. surface of the parking area showing contamination (ice, snow or water);
- e. strong wind, in particular if the direction is frontal to the aircraft;
- f. wing surfaces contaminated by snow or ice.
- g. Landing gear dumper pressure.

Note: For items d. and e. refer to alerts and/or NOTAM issued by the competent airport authorities.

In the impossibility of being able to keep under control some of the variables described above and in order to ensure the integrity of passengers and staff, avoid damage to the aircraft and equipment, it is mandatory that the Ramp Supervisor ensures the following sequence of unloading and loading:

OFFLOAD FIRST AFT HOLD

LOAD FIRST FORWARD HOLD

For flights operated by A330 aircraft, if for technical reasons the fuel distribution in the tanks differs from the standard one, always respecting the rule of first unloading the aft hold first and loading the forward hold first, the Load Control will have to plan the load distributing at least 50% of the weights in the forward hold. On arrival, if it is not possible to unload the after hold first (i.e. locked door), it is mandatory to wait until all the passengers have disembarked before proceeding to unload the forward hold.

For flights operated by A320/A319 and A220 aircraft, in order to limit the risk of static tipping (considering the low influence of the Centre of Gravity position on fuel consumption) the load shall be planned to obtain a MACZFW value as central as possible compared to the safety limits given in the balance chart preferring, if the loading conditions allow it, the use of the only forward hold or, in case it is not possible, a balanced use of the holds.

For A321, in order to avoid eventual tail tipping, if the documentation relating to the load and weight & balance (Loadsheets, LDM and CPM) sent from the departure station contains the following message: "TAIL TIP 40.02 WARNING!! APPLY SPECIAL LOADING – OFFLOADING PROCEDURE" it is mandatory to strictly apply the following unloading sequence:

 Volume II HLM	WEIGHT & BALANCE	4.2	Page 12
	LOAD PLANNING	Ed 2 Rev 15/07 aug 25	

1. Notify the flight deck crew that the Tail Tipping prevention procedure is being applied.
2. 2. Unload the rear hold (AFT Hold), if loaded.
3. 3. Disembark the passengers.
4. 4. Unload the front hold (FWD Hold) only after the passengers have disembarked.

Note: The Warning message is independent of the MACZFW value present in the Loadsheet. The 40.02 data is processed by the ALTEA FM system based on a series of operational parameters.

For flights operated by A350 aircraft, always respecting the rule of first unloading the aft hold first and loading the forward hold first, the Load Control will have to plan the load distributing at least 50% of the weights in the forward hold.

On arrival, if it is not possible to unload the after hold first (i.e. locked door), it is mandatory to wait until all the passengers have disembarked before proceeding to unload the forward hold.

4.2.10 USE OF BALLAST

The use of ballast for balancing purposes is restricted to flights where passengers and or dead load are not sufficient to balance the aircraft.

This situation may be faced for transfer flights, ferry flights and training flights where there being no passengers on board.

Therefore, the use of ballast to bring the Centre of Gravity to ideal weight and balance conditions (e.g. optimized CG) is not allowed when the CG already falls within the limits.

BALLAST BAGS

ballast bags shall respect the following conditions:

weight—25 kg

contents—only dry shingle, coarse round gravel or pebbles of an average diameter of 12–15 mm must be used. Sand shall not be used.

material—canvas or hessian with an inner plastic bag effectively closed

marking—weight and name of owner

It is further recommended that ballast bags shall be stored indoors. If this is not possible they shall be placed on planks and protected against weather by means of canvas covers or other suitable covering.

Ballast bags shall periodically be checked for weight and condition.

BALLAST ULDs

Ballast ULDs should respect the following conditions:

Fulfill all airworthiness requirements regarding restraint rules

Be check weighed at maximum 3 month intervals and clearly marked with latest weight & date of weighing

Be protected from weather when not in use and should not be stacked

BALLAST FUEL

Ballast fuel must be shown as an adjustment to the dry operating weight which will then be included in the ZFW.

 Volume II HLM	WEIGHT & BALANCE	4.2	Page 13
	LOAD PLANNING	Ed 2/20 apr 2022	

4.2.11 LIMITATIONS

4.2.11.1 Structural aircraft limitations

Every aircraft has loading limitations intended to protect its structure against damage.

An aircraft is a flexible structure. In particular, the fuselage contorts during flight according to the load it contains. So that the fuselage contortion does not exceed at any point the maximum allowed limits, which would result in a risk of permanent damage, the structural loading limitations must be checked during the load planning and loading processes.

For each aircraft type, all applicable loading limitations are available in Company's manuals (Chap. 5.X. for ITA).

Note: If any load is identified to be exceeding standard aircraft load limitations this must be immediately reported to the Company's representative.

4.2.11.1.1 Point load limitation

It defines the resistance to puncture (by a heavy load resting on a very small surface) of the floor of a bulk compartment or the base of a ULD.

In order to avoid a floor puncture by point load during handling in an aircraft compartment, it is recommended to apply the elementary package handling precautions indicated hereafter.

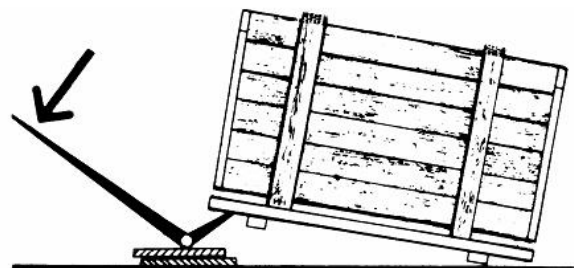
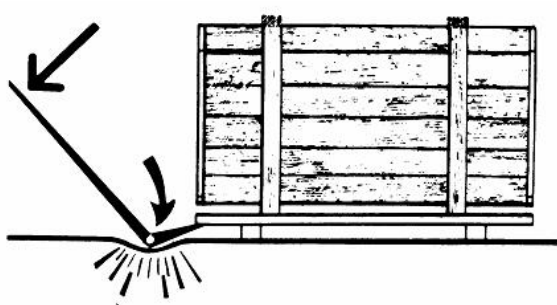
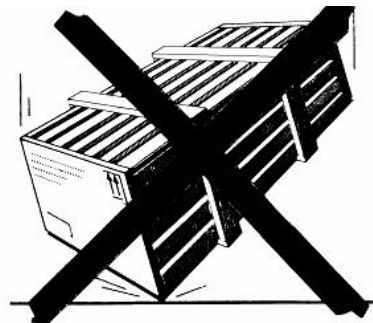
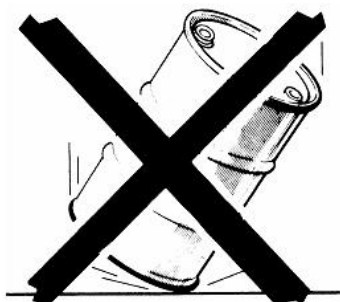

 Volume II HLM	WEIGHT & BALANCE	4.2	Page 14
	LOAD PLANNING	Ed 2/20 apr 2022	

4.2.11.1.2 Area load limitation

Area load limitation is the maximum load acceptable on any m² of a bulk compartment floor or ULD base. This limitation is expressed in Kg/m² (lb/sq.ft).

Limitation computation: the load limitation per m² must be computed dividing the weight of the load by the area defined by the external contour of the load contact points on the floor. If the ratio weight/surface exceeds aircraft limitation, a spreader floor is required.

In the example below the area to take into account is not the one of the crate, but the one defined by its feet.

A spreader floor must be placed under the load.

Example

The example below take into account a floor limitation of 732 Kg/m² where spread is required.

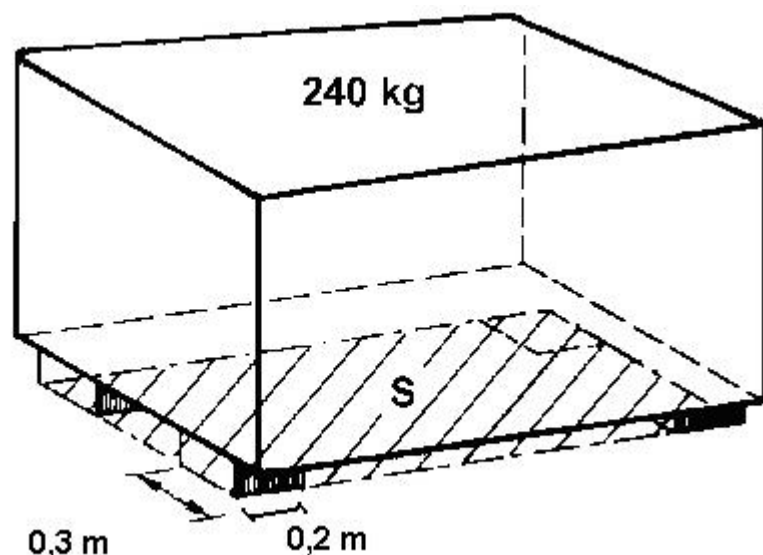

The surface to be taken into account is the area defined by the external contour of the contact points I (0.3 m) and L (0.20m).

Calculate the surface:

$$S = 0.3 \times 0.2 \times 4 = 0.24 \text{ m}^2$$

Check limitation:

$$S / W = 240 / 0.24 = 1000 \text{ Kg/m}^2 > 732 \text{ Kg/m}^2$$

 ITA AIRWAYS Volume II HLM	WEIGHT & BALANCE	4.2	Page 15
	LOAD PLANNING	Ed 2/20 apr 2022	

4.2.11.1.3 Linear (running) load limitation

Linear (running load) limitation is the maximum load acceptable on a given section of the fuselage. This limitation is expressed in Kg/m (lb/in) of the fuselage length.

In practice, this limitation determines the maximum weight allowed per section (bulk compartment) or position ULD (i.e. 11P).

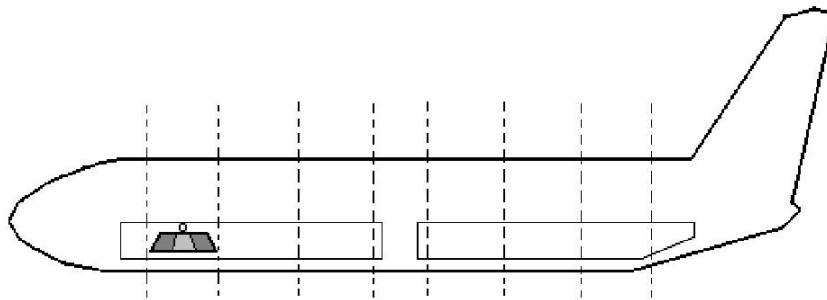

4.2.11.1.4 Cumulative load limitation

During the flight any fuselage section located forward or aft of the wing box is overhanging the wing box. This creates shear stress in the fuselage structure. In order not to exceed the maximum allowed limit, the manufacturer defines a cumulative limitation for the whole load located forward or aft of the wing box. The limitation is expressed in Kg (lb) maximum forward or aft of the wing box and includes all load located on the various decks (ULD and bulk).

In practice this limitation determines the maximum allowed load weight in the forward and aft compartments.

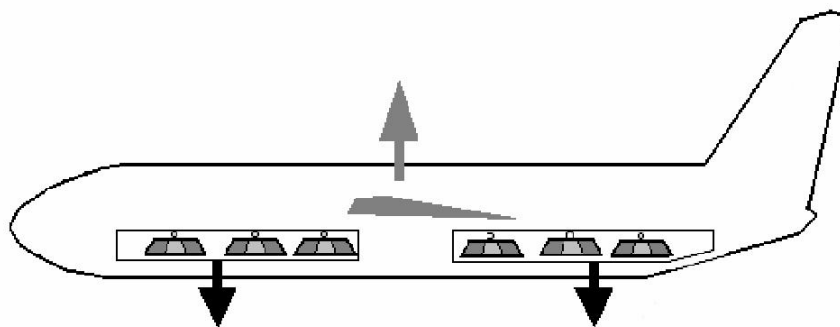

On passenger aircraft most of the time the cumulative limitations are not exceeded, when the maximum weight limitations for positions and sections are complied with.

 Volume II HLM	WEIGHT & BALANCE	4.2	Page 16
	LOAD PLANNING	Ed 2/20 apr 2022	

4.2.11.2 Loading limitations

All technical/operative/commercial information that could have a direct impact on the aircraft loading shall be available and taken into account before load planning and during loading operations.

Below some examples, but not limited to:

- holds inoperative (i.e. missing/inoperative nets or restraints)
- head system inoperative
- ventilation system inoperative
- CLS inoperative
- cabin passenger seats inoperative

The AMOS Report, for ITA, is distributed through the whole Network. The Load Controller is responsible for checking any limitation before issuing LIR. The Load Controller is responsible for checking any limitation before issuing LIR. Load Controller shall inform all the operators involved in loading operations by filling the “SI” box of the Loading Instructions with all the limitations/anomalies of the aircraft that could have a direct impact on loading/unloading operations.

 ITA AIRWAYS Volume II HLM	WEIGHT & BALANCE	4.2	Page 17
	LOAD PLANNING	Ed 2/20 apr 2022	

4.2.12 LOADING INSTRUCTION REPORT (LIR)

4.2.12.1 General

As loading operations checks are of utmost importance in terms of flight safety, instructions for the distribution on board shall:

- always be given in writing using the relevant forms (manual or EDP), including information about special loads.
- be issued for all departing aircraft, both originating and in transit.
- be signed by the loading supervisor after the flight is closed, reporting every variation to the original load and any anomaly/damage to cargo compartments eventually noticed during loading.
- be signed by the loading supervisor in the box "Cargo compartment visual check performed".
- be delivered to the Captain in order to verify coherence with Loadsheets and inform him about any anomaly/damage to cargo compartments.
- be withdrawn after Captain has countersigned for acceptance.
- be filed together with other flight documentation.

At Station discretion and for special local requirements, the form may also be issued for flights on arrival, particularly those employing containerized aircraft.

Note: Manual Company LIR are distributed to all network stations, however Company forms may be replaced by manual local forms or automatic forms processed by the DCS system (EDP LIR) providing the same information, including the two boxes:

- "Captain signature for acceptance".
- "Cargo compartment visual check performed" (or equivalent).

- A. The Company LOADING INSTRUCTIONS either manual or EDP forms comply with IATA/AHM requirements.
- B. LIR should be issued in the number of copies needed for performing ground operations.
- C. For ITA flights operated with Wide Body aircraft, the manual LIR (Loading Instructions Report) form shall always be used.
- D. The box "Load Distribution At Departure" must be filled during loading, reporting all variations to the original instructions.
- E. Load destinations should be indicated using the three letter IATA codes of the airport.
- F. All weights must be in whole Kilograms: decimal values equal to or above 0.5 should be rounded off to the higher figure (e.g. 3.49=3, 3.5=4 and 3.51=4).
- G. The types of ULD should be indicated according to IATA codes, however if a local EDP LIR is used, Company DCS codes are also accepted.

 Volume II HLM	WEIGHT & BALANCE	4.2	Page 18
	LOAD PLANNING	Ed 2/20 apr 2022	

- H. For cargo, mail and company equipment loaded in hold as bulk, the corresponding loading position, code (C=Cargo, M=Mail and E=Company Equipment) and load net weight shall be indicated.
- I. For cargo, mail and company equipment loaded in ULD, its loading position, code (C=Cargo, M=Mail and E=Company Equipment) and gross weight (load net weight + ULD tare weight) shall be indicated.
- J. Position baggage loaded on board must be reported in the appropriate box specifying the distribution criteria (F=PRIORITY baggage, B=LOCAL baggage) and pieces quantity, while weight is optional.
- K. Any information related to special load details must be reported in “Special Instructions” box.
- L. Once loading operations are completed, the original copy, containing all variations to the original instructions and duly signed by the load supervisor, must be delivered to the Captain in order to verify its coherence with Loadsheets.
- M. Once the Captain has verified data, he must sign the form in acceptance and give it back to the load supervisor.
- N. The original copy must be filed at the issuing station.

4.2.12.2 Form

LIR form shall includes the following information:

Sections	Identification of items	
	Bulk aircraft	Containerized aircraft
1. Heading	<ul style="list-style-type: none"> - box FLIGHT - box A/C REG. - box DATE - box STATION - box DESTINATIONS - box PREPARED BY 	<ul style="list-style-type: none"> - box FLIGHT - box A/C REG. - box DATE - box STATION - box DESTINATIONS - box PREPARED BY
2. Load positions	<ul style="list-style-type: none"> - aircraft layout - column CMPT - column MAX WT (Kg) 	<ul style="list-style-type: none"> - boxes indicating all loading positions of the aircraft
3. Unloading instructions	<ul style="list-style-type: none"> - column LOAD DISEMBARKING - column LOAD IN TRANSIT 	<ul style="list-style-type: none"> - section LOAD DISTRIBUTION AT ARRIVAL
4. Loading instructions	<ul style="list-style-type: none"> - column LOAD IN TRANSIT - column LOAD EMBARKING - box SPECIAL INSTRUCTIONS 	<ul style="list-style-type: none"> - section LOAD DISTRIBUTION AT ARRIVAL - sections LOADING INSTRUCTIONS - box SPECIAL INSTRUCTIONS
5. Loading report	<ul style="list-style-type: none"> - box SPECIAL INSTRUCTIONS - column DEVIATIONS - box SIGNATURE OF LOADING SUPERVISOR OR PERSON RESPONSIBLE FOR LOADING - box SIGNATURE OF CARGO COMPARTEMENT VISUAL CHECK PERFORMED - box CAPTAIN SIGNATURE FOR ACCEPTANCE 	<ul style="list-style-type: none"> - box SPECIAL INSTRUCTIONS - section LOAD DISTRIBUTION AT DEPARTURE - box SIGNATURE OF LOADING SUPERVISOR OR PERSON RESPONSIBLE FOR LOADING - box SIGNATURE OF CARGO COMPARTEMENT VISUAL CHECK PERFORMED - box CAPTAIN SIGNATURE FOR ACCEPTANCE

 Volume II HLM	WEIGHT & BALANCE	4.2	Page 20
	LOAD PLANNING	Ed 2/20 apr 2022	

4.2.12.3 Compilation and use

Heading Box:

Enter the data in the boxes provided identifying:

- Flight number
- Aircraft registration
- Date
- Station
- Destination
- Prepared By (signature)

“Load Distribution At Arrival” Box

This section is mandatory only for transit or circular flights and if required by local regulation.

A. Bulk aircraft

Enter data for load disembarking and/or in transit in the boxes provided.

Note: Data is obtained from the loading message (LDM) dispatched by the preceding station. In case of transmission/reception problems with the LMD message, the copy of the Loadsheet on board the aircraft may be consulted.

B. Containerized aircraft

Enter ULD and bulk load data: ULD type, destination, weight, content.

Note: Data is obtained from the CPM message dispatched by the preceding station. In case of transmission/reception problems with the CPM message, the copy of the LIR or Loadsheet on board the aircraft may be consulted. Highlight the ULDs and bulk load to be unloaded (e.g. by underlining the destination).

“Loading Instructions” Box

A. Bulk aircraft

Enter instructions using appropriate boxes for:

- Transit Load (repositioning, partial unloading, etc.)
- On load at this station

B. Containerized aircraft

Enter instructions for distribution of embarking ULDs and bulk load.

Highlight the ULDs to be temporarily unloaded so as to:

- use residual space (top up)
- redistribute the contents (re-load)
- reposition the ULDs (move)
- place them back in the right order (re-sequence)
(e.g. placing brackets around or circling the loading position and/or entering a note about it in the "Special Instructions" box).

 Volume II HLM	WEIGHT & BALANCE	4.2	Page 21
	LOAD PLANNING	Ed 2/20 apr 2022	

“Special instructions” Box

Use the "Special Instructions" box to:

- highlight any special loads and items to be restrained
- highlight any piercing, sharp or high density (if over 320 Kg/m³) cargo
- specify the entity of any "stand-by" goods
- mark any checks to be performed
- give instructions for any required partial unloading of transit load
- highlight any aircraft limitation or anomaly that could have a direct impact on loading operations
- give any other useful information to Loading Supervisor and/or Loading Team

Bottom Box

- *“Cargo Compartment Visual check Performed”* to be signed by Loading Supervisor or person responsible for loading.
- *“I undersigned assure that the aircraft has been loaded as per these instructions (signature of loading supervisor or person responsible for loading)”*, self explanatory.
- *“Captain Signature for acceptance”*, self explanatory.

Note: The Loading Supervisor's signature will in any case certify that:

- the loading of the aircraft has been carried out according to the instructions on the form
- any deviations introduced have been recorded
- where required the bulk load and the ULDs have been restrained according to Company regulations
- the holds visual inspection have been performed

Manual LIR form example

	LOADING INSTRUCTIONS ISTRUZIONI PER IL CARICO	A320	LOAD CONFIGURATION -- A -- CLS (Cargo Loading System) Installed Up to n.7 AKH / PKC	FLIGHT NR 2017	A/C REG EI-DTE	DATE 16 FEB 13																																														
			STATION FCO	DESTINATIONS L/N	PREPARED BY VEB91 M.																																															
LOAD DISTRIBUTION AT ARRIVAL	<table border="1"> <tr> <td>5</td> <td>42</td> <td>41</td> <td>32</td> <td>31</td> </tr> <tr> <td>C 92</td> <td>AKH</td> <td>AKH</td> <td>AKH</td> <td>AKH</td> </tr> <tr> <td>B 100</td> <td>17A13AZ</td> <td>0011A AZ</td> <td>0642AAZ</td> <td>0432AAZ</td> </tr> <tr> <td></td> <td>B125</td> <td>B125</td> <td>B150</td> <td>B200</td> </tr> </table>	5	42	41	32	31	C 92	AKH	AKH	AKH	AKH	B 100	17A13AZ	0011A AZ	0642AAZ	0432AAZ		B125	B125	B150	B200	<table border="1"> <tr> <td>13</td> <td>12</td> <td>11</td> </tr> <tr> <td>N</td> <td>N</td> <td>N</td> </tr> </table>	13	12	11	N	N	N	LOAD DISTRIBUTION AT DEPARTURE	<table border="1"> <tr> <td>5 (BULK)</td> <td>42</td> <td>41</td> <td>32</td> <td>31</td> </tr> <tr> <td>C M B</td> <td>AKH</td> <td>AKH</td> <td>AKH</td> <td>AKH</td> </tr> <tr> <td></td> <td>B</td> <td>B</td> <td>B</td> <td>C</td> </tr> </table>	5 (BULK)	42	41	32	31	C M B	AKH	AKH	AKH	AKH		B	B	B	C	<table border="1"> <tr> <td>13</td> <td>12</td> <td>11</td> </tr> <tr> <td>X</td> <td>X</td> <td>X</td> </tr> </table>	13	12	11	X	X	X
5	42	41	32	31																																																
C 92	AKH	AKH	AKH	AKH																																																
B 100	17A13AZ	0011A AZ	0642AAZ	0432AAZ																																																
	B125	B125	B150	B200																																																
13	12	11																																																		
N	N	N																																																		
5 (BULK)	42	41	32	31																																																
C M B	AKH	AKH	AKH	AKH																																																
	B	B	B	C																																																
13	12	11																																																		
X	X	X																																																		
LOAD DISTRIBUTION AT DEPARTURE	<table border="1"> <tr> <td>5 (BULK)</td> <td>42</td> <td>41</td> <td>32</td> <td>31</td> </tr> <tr> <td>C 70 kg</td> <td>AKH</td> <td>AKH</td> <td>AKH</td> <td>AKH</td> </tr> <tr> <td>M 5 kg</td> <td>B25RS</td> <td>B23RS</td> <td>B18RS</td> <td>C 225 kg</td> </tr> <tr> <td>B 4 RS</td> <td></td> <td></td> <td></td> <td></td> </tr> </table>	5 (BULK)	42	41	32	31	C 70 kg	AKH	AKH	AKH	AKH	M 5 kg	B25RS	B23RS	B18RS	C 225 kg	B 4 RS					<table border="1"> <tr> <td>13</td> <td>12</td> <td>11</td> </tr> <tr> <td>X</td> <td>X</td> <td>X</td> </tr> </table>	13	12	11	X	X	X	LOAD DISTRIBUTION AT DEPARTURE	<table border="1"> <tr> <td>13</td> <td>12</td> <td>11</td> </tr> <tr> <td>AKH</td> <td>AKH</td> <td>AKH</td> </tr> <tr> <td>02736 AZ</td> <td>11262 AZ</td> <td>12351 AZ</td> </tr> <tr> <td>X</td> <td>X</td> <td>X</td> </tr> </table>	13	12	11	AKH	AKH	AKH	02736 AZ	11262 AZ	12351 AZ	X	X	X										
5 (BULK)	42	41	32	31																																																
C 70 kg	AKH	AKH	AKH	AKH																																																
M 5 kg	B25RS	B23RS	B18RS	C 225 kg																																																
B 4 RS																																																				
13	12	11																																																		
X	X	X																																																		
13	12	11																																																		
AKH	AKH	AKH																																																		
02736 AZ	11262 AZ	12351 AZ																																																		
X	X	X																																																		

(1) Max Load 1122 kg with LWE TL system installed
 (2) including pallets or container tare weight

SPECIAL INSTRUCTIONS (including any anomalies evidenced - include eventuali anomalie riscontrate)
 This aircraft has been loaded in accordance with these instructions including the operations shown on the "LOAD DISTRIBUTION AT DEPARTURE". The load has been secured in accordance with Company Regulations.
 Il carico di questo aeromobile è stato effettuato secondo le istruzioni del presente modulo. Le eventuali variazioni apportate sono state registrate nel riquadro "LOAD DISTRIBUTION AT DEPARTURE". Il carico è stato ancorato secondo le norme di Compagnia.

CARGO COMPARTMENT VISUAL CHECK PERFORMED
 I undersigned assure that the aircraft has been loaded as per these instructions (signature of loading supervisor or person responsible for loading)
 Captain signature for acceptance

Mod. MSS LI A320 - A - Rev. 3 APR13

EDP LIR form example

```

LOADING INSTRUCTION/REPORT PREPARED BY XXXXXXXXXX          EDNO
ALL WEIGHTS IN KG                                           1
FROM/TO FLIGHT A/C REG  VERSION  GATE TARMAC  DATE  TIME
FCO MAD AZ058  BTMB  A319-112  LOC 311    23MAR23 0626
PLANNED JOINING LOAD
MAD  J 9      Y 119  C 0      M 0      B 2303
JOINING SPECS:  SEE SUMMARY
TRANSIT SPECS:  SEE SUMMARY
RELOADS:

ACTUAL
PIECES
WEIGHT
LOADING INSTRUCTION
*****
CPT 1      MAX 02268
:11 AKH11AZ*
:ONLOAD: MAD BY/
:      460/25PCS* AKH 14404 AZ  (29)
:SPECs: NONE
:REPORT:
-----
:12 AKH10AZ*
:ONLOAD: MAD BY/
:      460/25PCS* AKH 13950 AZ  (34)
:SPECs: NONE
:REPORT:
CPT 1 TOTAL:
-----
CPT 4      MAX 02268
:41 AKH9AZ*
:ONLOAD: MAD BY/
:      460/25PCS* AKH 15203 AZ  (17)
:SPECs: NONE
:REPORT:
-----
:42 AKH8AZ*
:ONLOAD: MAD BY/
:      460/25PCS* AKH 12548 AZ  (18)
:SPECs: NONE
:REPORT:
CPT 4 TOTAL:
-----
CPT 5      MAX 01497
:51
:ONLOAD: MAD D/5PCS
:      BT R/  → (2) B. TRANSFER
:      89/4PCS*
:      BJ R/
:      151/10PCS*
:      BY R/  → (2) B. LOCAL (PARCY-SIMONE)
:      153/10PCS*
:      BG R/
:      70/9PCS*
:      BR R/
:      0*
:SPECs: NONE
:REPORT:
CPT 5 TOTAL:

```

 ITA AIRWAYS Volume II HLM	WEIGHT & BALANCE	4.2	Page 24
	LOAD PLANNING	Ed 2 Rev 3/26 may 23	

 NO SPECIAL LOAD/DANGEROUS GOODS
 SI DOI 47.5
 DOW 41763

Lawrence Shaw

CARGO COMPARTMENT VISUAL CHECK PERFORMED / SIGNATURE XXXXXXXXXXXXX

THIS AIRCRAFT HAS BEEN LOADED IN ACCORDANCE WITH THESE INSTRUCTIONS INCLUDING THE DEVIATIONS SHOWN ON THE REPORT, THE CONTAINERS, PALLETS AND BULK LOAD HAVE BEEN SECURED IN ACCORDANCE WITH COMPANY REGULATIONS.
 SIGNATURE / NAME XXXXXXXXXXXX *[Signature]*

CAPTAIN SIGNATURE FOR ACCEPTANCE *[Signature]*

 ITA AIRWAYS Volume II HLM	WEIGHT & BALANCE	4.3	Page 1
	LOADSHEET	Ed 2/20 apr 2022	

4.3 LOADSHEET

4.3.1 GENERAL INFORMATION

- a. The LoadsHEET form allows to:
 - show that traffic embarked and aircraft weights respect the limitations given by the Company
 - determine the maximum weight available for traffic load in relation to the leg to be flown
 - obtain the necessary data for compilation of the balance chart
 - indicate the weight and distribution of the traffic loaded divided, by route destinations
 - provide operating and traffic data to be sent with load messages
- b. LoadsHEET may be issued in two different way:
 1. Manual LoadsHEET
 2. Processed LoadsHEET by EDP automatic system:
 - printed on plain paper
 - sent via ACARS
- c. Manual Loadsheets are structured in such a way as to allow the load message (LDM) to be sent according to standard format.
The text of the message consists of the data compiled in the shaded boxes of the form
- d. LoadsHEET shall be prepared by all stations for every departing aircraft. It's compilation is usually the task of Load Control office. Captain is responsible to inform this office of the quantity of fuel to be loaded, of the required trip fuel and any other necessary data (e.g. special operational limitations). Such data may be forwarded through the Operations Centre, where present.
- e. Upon completion, LoadsHEET is submitted for approval to the aircraft Captain, who shall sign it in the space provided or electronically (ACARS)

Note: ACARS LoadsHEET is accepted with an electronic signature.

Note: LoadsHEET shall be delivered to the Captain: at least 5 minutes before ETD (print on plain paper EDP) or at least 7 minutes before ETD (ACARS EDP).

- f. LoadsHEET shall be prepared in two or three copies and distributed as follows:
 - 1st copy (original)**
To be delivered to the aircraft Captain for operational documentation of the flight.
This copy can be consulted but NOT kept by subsequent line stations.
 - 2nd copy**
To be filed by the issuing station.
This copy shall be used for sending load messages when requested.
 - 3rd copy**
To be used for other requirements (i.e. on request by local Authority)

Note: At stations where the LoadsHEET is compiled in by a handling agent the forms here referred to may be replaced by local forms, as long as equivalent.

A limited number of forms are also available in operations document bag on board the aircraft.

 ITA AIRWAYS Volume II HLM	WEIGHT & BALANCE	4.3	Page 2
	LOADSHEET	Ed 2/20 apr 2022	

4.3.2 WEIGHTS DEFINITION AND CALCULATION

4.3.2.1 Weight Limits

MTW (Maximum design Taxi Weight)

This is the maximum allowed aircraft weight for ground manoeuvres, assessed according to the aircraft's structural strength and other airworthiness requirements. It includes the taxi fuel weight.

MTOW (Maximum design Take-Off Weight)

This is the maximum allowed weight of the aircraft at the beginning of the take-off run (brakes released), assessed according to the aircraft's structural strength and other airworthiness requirements.

RTOW (Regulated Take-Off Weight) or OTOW (Operational Take-Off Weight)

This is the maximum allowed weight for take-off (brakes released) at a specific airport subject to runway limitations etc., **shall not exceed the MTOW.**

MLW (Maximum design Landing Weight)

This is the maximum weight of the aircraft for landing (upon touching the ground), assessed according to the aircraft's structural strength and other airworthiness requirements.

OLW (Operational Landing Weight)

This is the maximum authorised landing weight of the aircraft (upon touching the ground) at a specific airport subject to runway limitations etc., **shall not exceed MLW.**

MZFW (Maximum design Zero Fuel Weight)

This is the maximum allowed aircraft weight without consumable fuel, assessed according to the aircraft's structural strength and other airworthiness requirements.

ATOW (Allowed Weight for Take-Off)

This is the maximum aircraft weight calculated for take-off (brakes released) in relation to the particular leg to be flown.

It is determined by comparing:

- a. maximum zero fuel weight + TOF.
- b. maximum take-off weight.
- c. maximum landing weight + TF.

The lowest of the values (a), (b) and (c) will be RTOW.

 ITA AIRWAYS Volume II HLM	WEIGHT & BALANCE	4.3	Page 3
	LOADSHEET	Ed 2/20 apr 2022	

4.3.2.2 Traffic load

Traffic load or payload

This consists of passengers (both "revenue" and "non-revenue") and deadload.

Note: Crew members travelling as passengers are also included.

Note: On manual Loadsheet the following items not on manifest shall also be indicated as traffic load: extra spare parts, extra catering carried in the cargo hold and ballast.

On Loadsheet issued by an automatic system (EDP), these items may be included in the DOW.

Deadload

This consists of baggage, gate delivery items, cargo (both "revenue" and "non-revenue") and mail local or transit loaded as bulk load or in ULDs.

Maximum traffic load

This is the maximum allowed traffic load weight which may be embarked onto an aircraft when there are no other restrictions imposed by airport limitations (see OTOW and OLW) or the fuel data (TOF AND TF).

It is calculated as follows: **MZFW-DOW**

ATL (allowed traffic load)

This is the maximum allowed weight of the traffic load for a particular leg of flight.

It is calculated as follows: **RTOW - OH**

TW (traffic load per destination)

This is the weight of the traffic load destined for each station. When considering the data regarding the destination concerned, the TW is calculated as follows: **passengers weight + deadload weight.**

TTL (total traffic load)

This is the weight of all the traffic load on board the aircraft.

It is calculated as follows:

weight of all passengers + all deadload weight

or

TW 1st destination + TW 2nd destination + ...

Underload

This is the weight still available for the traffic load.

It is calculated as follows: **ATL - TTL**

It is mainly used as a means of comparison for a positive value in "last minute changes (LMC)" regarding the traffic load.

 Volume II HLM	WEIGHT & BALANCE	4.3	Page 4
	LOADSHEET	Ed 2/20 apr 2022	

4.3.2.3 Actual weight

BEW (Basic Empty Weight)

This is made up of the structure, engines, furnishings, power-plants, fittings, power-plant fluids and non-consumable fuel.

BOW (Basic Operating Weight)

This is the empty weight plus equipment and crew (standard spare parts, standard cabin and catering equipment, crew, mail flights equipment, etc.).

DOW (Dry Operating Weight)

This is the aircraft weight without traffic load or fuel. It is calculated by the algebraic sum: **BOW + any corrections for equipment used**. These corrections may be due to:

- additional crew members (with respect to those included in the BOW)
- extra catering transported in the galleys
- ballast fuel
- etc.

Note: On the Loadsheets, all the elements mentioned above shall be considered as non revenue load.

OW (Operating Weight)

This is the aircraft weight without traffic load.

It is calculated as follows: **DOW + TOF**

AZFW (Actual Zero Fuel Weight)

This is the aircraft weight without consumable fuel. It includes the traffic load.

It is calculated as follows: **DOW + TTL**

Shall not exceed the maximum zero fuel weight.

Actual Taxi or Ramp Weight

This is the aircraft weight in the parking stand with engines off.

It includes the traffic load and total fuel.

It is calculated as follows: **AZFW + total fuel**

Shall not exceed the maximum taxi weight.

ATOW (Actual Take-Off Weight)

This is the weight of the aircraft at the beginning of the take-off run (brakes released).

It includes the traffic load and take-off fuel.

It is calculated as follows: **AZFW + TOF**

Shall not exceed the maximum take-off weight.

 Volume II HLM	WEIGHT & BALANCE	4.3	Page 5
	LOADSHEET	Ed 2/20 apr 2022	

ALW (Actual Landing Weight)

This is the aircraft landing weight (on touching the ground) at the first intended station.

It includes the traffic load and reserve fuel.

It is calculated as follows: **ATOW + TF**

Shall not exceed the maximum landing weight.

 Volume II HLM	WEIGHT & BALANCE	4.3	Page 6
	LOADSHEET	Ed 2/20 apr 2022	

4.3.2.4 Weight and balance conditions

CG (centre of gravity)

For an aircraft, it is the point where its total weight is considered to be applied.

Moment

This is the force resulting from the weight produced by a body multiplied by its distance (known as "arm") from a given reference point.

MAC (mean aerodynamic chord)

The "chord" of a wing profile is the distance between its attachment and its outer edge.

The "aerodynamic mean chord " is the mean profile chord of a tapering wing.

The position of the MAC with respect to the wing and fuselage is known with a very high degree of exactitude.

Balance condition

This is the position of the CG expressed in "moment index" or "MAC percentage".

The more commonly used CG positions are:

- a. Expressed in moment index:
 - **BOI** basic operating index:
CG relative to the BOW
 - **DOI** dry operating index:
CG relative to the DOW
 - **DLI** deadload index:
CG after deadload loading
 - **LIZFW** loaded index at zero fuel:
CG relative to the AZFW
 - **LITOW** loaded index at take-off:
CG relative to the ATOW
 - **LILAW** loaded index at landing:
CG relative to the ALW

- b. Expressed in MAC percentage:
 - **MACZFW%** - % MAC at zero fuel:
CG relative to the AZFW
 - **MACTOW%** - % MAC at take- off:
CG relative to the ATOW
 - **MACLAW%** - % MAC at landing:
CG relative to the ALW

 ITA AIRWAYS Volume II HLM	WEIGHT & BALANCE	4.3	Page 7
	LOADSHEET	Ed 2/20 apr 2022	

4.3.3 FUEL FIGURES

4.3.3.1 Preamble

Fuel density may vary according to the temperature, Load Controller shall ensure that right values are used regarding default parameters set on DCS system.

4.3.3.2 Fuel Definitions

Block Fuel

Total usable fuel on board before starting engines minus fuel intended as ballast.

Taxi Fuel

A standard or actual quantity of fuel to cover engine start and ground manoeuvres until start of take-off, and APU consumption. The amount may be increased when required by local conditions.

The weight of Taxi Fuel will be calculated by Flight Dispatch and printed on the Flight Plan.

TOF (Take-off Fuel)

All the usable fuel on board upon take-off, except fuel considered as ballast.

Is calculated as follows: **Block Fuel-Taxi Fuel**

TF (Trip Fuel)

Fuel required to fly from the airport of departure to the planned destination, based on 'Planned Operating Conditions'. This amount shall include fuel for take-off, acceleration, climb, cruise, descent, approach and landing.

Reserve Fuel

Is the fuel quantity left on board after landing at the planned destination.

Is calculated as follows: **Block Fuel-Taxi Fuel-Trip Fuel**. Or **Take-Off Fuel-Trip Fuel**.

Ballast Fuel

Fuel intended as ballast. This fuel shall be included in the Zero Fuel Weight, cannot be used, and must remain in the tank(s) throughout the duration of the flight.

 Volume II HLM	WEIGHT & BALANCE	4.3	Page 8
	LOADSHEET	Ed 2/20 apr 2022	

4.3.3.3 “Just in Time Refuelling” procedure (JITR)

The purpose of this procedure is to reduce fuel consumption, in order to be comply with the aircraft Block Fuel data is delivered according to the final ZFW weight data (ACT ZFW) and not the estimated (PLN ZFW) one.

Preliminary fuel may be delivered according to the table below, while final fuel will be communicated by the Captain once he received via ACARS from Flight Dispatch the "Summary Fuel Page".

Final Fuel will be delivered during passengers boarding, the Station is responsible to coordinate the fuelling operation with passengers on board in accordance Company procedure as described in Cap. 8.6 REFUELLING and in compliance with local regulation. If time lines may not be respected, Station personnel and Captain coordinate each other in order to complete refuelling operation safely without penalizing the flight punctuality.

Aircraft type	Preliminary fuel quantity to load as per OFP	Communication of final Block Fuel Captain
WIDE BODIES	Preliminary fuel - 3 Tons	ETD - 20'
NARROW BODIES	n/a	n/a

A copy of “Summary Fuel Page” signed by the Captain shall be filed in flight file.

Note: if "Just In Time Refuelling" procedure is not applicable, ITA supervision must inform both Flight Dispatch within ETD -90' and Captain as soon as he gets on the aircraft.

 ITA AIRWAYS Volume II HLM	WEIGHT & BALANCE	4.3	Page 9
	LOADSHEET	Ed 2/20 apr 2022	

Example of “Summary Fuel Page”

IDISA - AZ00784 - 12 APR 2012

```

NEWZFW      158500
NEWTOW      238230
TRIP    67883 11.31
CONT     2036 00.21
ALTN     2677 00.26  RJTT
FINRES    2428 00.30
EROPS       0 00.00
TANKER    2000 00.20
PLNTOF   77024 13.08
DIFF      2706 00.22  RJGG
REQTOF   79730 13.30
EXTRA       0 00.00
ACTTOF   79730 13.30
TAXI       800 00.32
BLOCK    80530 14.02
.....

```

MDF 7258

INFO ALTERNATES

```

RJGG  00.48  4830
      22  2153
RJBB  01.02  6004
      36  3327
RJFF  01.37  8962
      71  6285

```

ATS ROUTE

FPL-AZA784-IS

-B772/H-SDGHIJPRXWYZ/SD

-LIRF1310

-N046BF330 OKUNO UL5 LAMIT UN978 EROBA/N0477F350 UN978

SUVUR/K0878F350 UN978 TP UM987 KOKIV UA137 GOBUN/K0872F350 B110

RASAP A279 OLAMI B481 SUBIK G712 INGEN G710 OTKER R211

ABDIR/K0884F370 R211 LANEP/K0800F330 B358 IKADA/K0843F370 B358

IGROD/N0451F370 Y301 SHELY/N0457F360 Y30 MELON DAISY

-RJAA1121 RJTT

 ITA AIRWAYS Volume II HLM	WEIGHT & BALANCE	4.3	Page 10
	LOADSHEET	Ed 2 Rev 9/14 jun 24	

4.3.3.4 A330 non-standard fuel distribution

If, for technical reasons, the fuel distribution in A330 and A350 aircraft tanks differs from the standard, the MACTOW and LITOW (Loading Index Take Off weight) shall be calculated and changed manually on the Loadsheets. Only local Load Control is authorized to perform this task (FCO Load Control is entitled only for diversions); it shall receive from the flight's Captain, the document "NON-STANDARD FUEL DISTRIBUTION FORM" (hereinafter identified to as "form") the Take Off Fuel expressed in Kg and the distribution in each tank. The form will be available in the aircraft documents bag and, if necessary, can also be found on the Company Intranet / Extranet.

4.3.3.4.1 Load planning and anti tipping

See Chap. 4.2.9 TIPPING PREVENTION.

4.3.3.4.2 Finalisation procedure for aircraft subject to NSFD

The departure station is responsible for finalising and completing the loading plan, local station is responsible for the correct calculation of the MACTOW and for sending the loading plan via acars on board.

Captain shall notify the Ramp Agent of the failure, informing him that the fuel distribution will be non-standard.

It is the responsibility of the Captain to fill in the blank parts of the form. Once completed he will hand it over to the Ramp Agent who will promptly inform the local Load Control.

If the failure is present on the AMOS Report, Load Control is still required to request confirmation from the Captain.

The departure station shall finalise the load and is responsible for adding Supplementary Information and Remarks on LDM and/or CPM to facilitate unloading.

Local Load Control is responsible for filling in the grey parts of the form and must:

1. use the fuel curve graph or the table present in the "Mass_Balance documentation" folder of the Extranet, detect the $\Delta M.I.$ concerning the quantity of fuel present in each tank and calculate the total $\Delta M.I.$, reporting the data in the relative fields of the form;
2. enter in the "comment" field of the loading plan the information "NO STANDARD FUEL DISTRIBUTION APPLIED, ACTUAL LITOW XXX, ACTUAL MACTOW XXX".
3. send the load plan to the Commander via ACARS.
4. local load control is responsible for archiving all documentation used for the calculation of the new ACTUAL LITOW and ACTUAL MACTOW values

Note: Departure Station will collect a copy of the form signed by Captain in order to store it in the flight trip file

4.3.3.4.3 A330 - fuel curve graph per tank

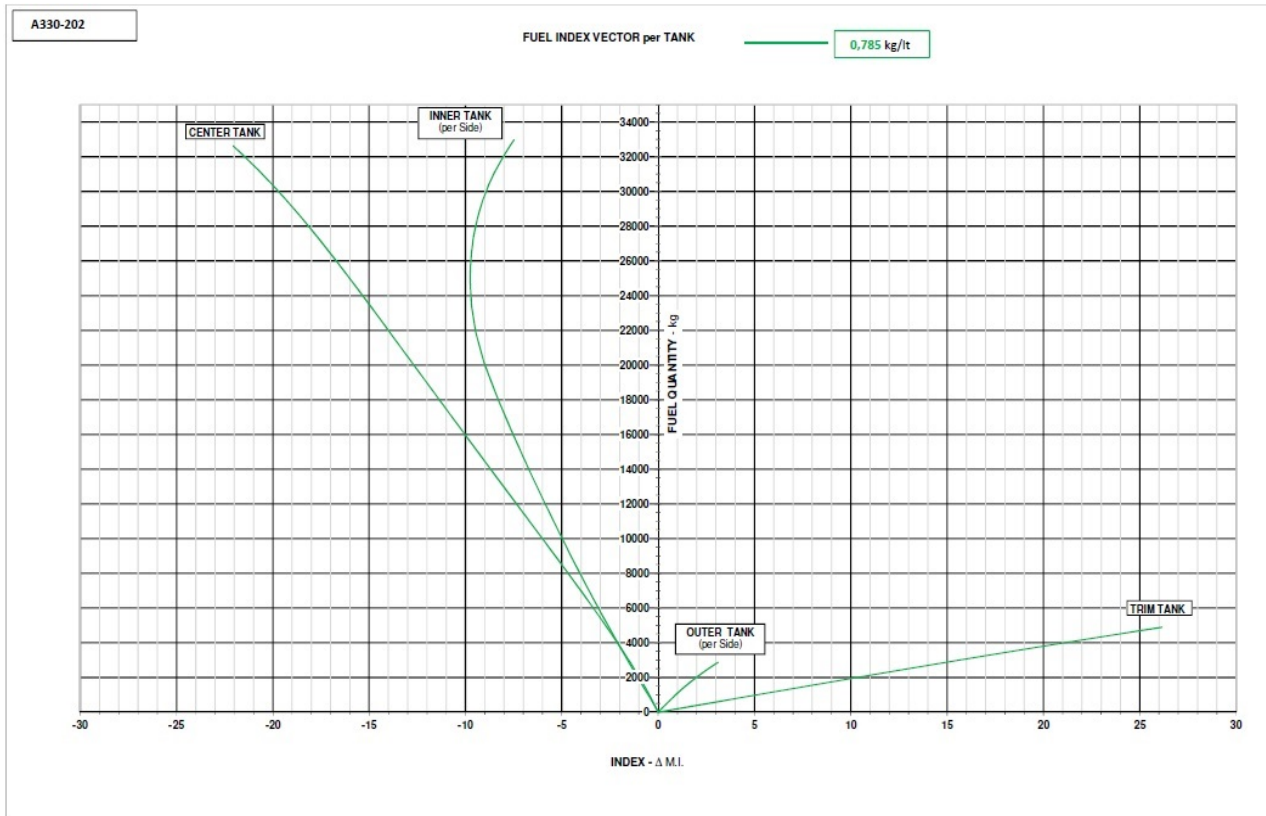

4.3.3.4.4 A330 - fuel table per tank

INNER TANK (per side)		OUTER TANK (per side)		CENTER TANK		TRIM TANK	
0	0,0	0	0,0	0	0,0	0	0,0
300	-0,2	200	0,1	300	-0,1	200	0,8
600	-0,3	300	0,3	600	-0,3	300	1,6
900	-0,5	500	0,4	900	-0,4	500	2,4
1300	-0,7	600	0,6	1300	-0,6	600	3,2
1600	-0,8	800	0,7	1600	-0,8	800	4,0
1900	-1,0	900	0,9	1900	-0,9	900	4,9
2200	-1,2	1100	1,0	2200	-1,1	1100	5,7
2500	-1,3	1300	1,2	2500	-1,3	1300	6,5
2800	-1,5	1400	1,3	2800	-1,4	1400	7,3
3100	-1,7	1600	1,5	3100	-1,6	1600	8,1
3500	-1,8	1700	1,7	3500	-1,8	1700	8,9
3800	-2,0	1900	1,9	3800	-2,0	1900	9,8
4100	-2,2	2000	2,0	4100	-2,2	2000	10,6
4400	-2,3	2200	2,2	4400	-2,4	2200	11,4
4700	-2,5	2400	2,4	4700	-2,6	2400	12,2
5000	-2,6	2500	2,6	5000	-2,8	2500	13,0
5300	-2,8	2700	2,8	5300	-2,9	2700	13,9
5700	-2,9	2800	3,1	5700	-3,1	2800	14,7
6000	-3,1	2900	3,1	6000	-3,4	3000	15,6
6300	-3,2			6300	-3,6	3100	16,4
6600	-3,4			6600	-3,8	3300	17,2
6900	-3,5			6900	-4,0	3500	18,1
7200	-3,7			7200	-4,2	3600	19,0
7500	-3,8			7500	-4,4	3800	19,8
7900	-4,0			7900	-4,6	3900	20,7
8200	-4,1			8200	-4,8	4100	21,6
8500	-4,3			8500	-5,0	4200	22,4
8800	-4,4			8800	-5,2	4400	23,3
9100	-4,6			9100	-5,4	4600	24,2
9400	-4,7			9400	-5,6	4700	25,1
9700	-4,9			9700	-5,8	4900	26,2
10000	-5,0			10000	-6,0		
10400	-5,1			10400	-6,3		
10700	-5,3			10700	-6,5		
11000	-5,4			11000	-6,7		
11300	-5,6			11300	-6,9		
11600	-5,7			11600	-7,1		
11900	-5,8			11900	-7,3		
12200	-6,0			12200	-7,5		
12600	-6,1			12600	-7,7		
12900	-6,2			12900	-7,9		
13200	-6,4			13200	-8,2		
13500	-6,5			13500	-8,4		
13800	-6,6			13800	-8,6		
14100	-6,8			14100	-8,8		
14400	-6,9			14400	-9,0		
14800	-7,0			14800	-9,2		
15100	-7,2			15100	-9,4		
15400	-7,3			15400	-9,6		
15700	-7,4			15700	-9,8		
16000	-7,5			16000	-10,0		
16300	-7,7			16300	-10,3		
16600	-7,8			16600	-10,5		
17000	-7,9			17000	-10,7		
17300	-8,0			17300	-10,9		
17600	-8,1			17600	-11,1		
17900	-8,3			17900	-11,3		
18200	-8,4			18200	-11,5		
18500	-8,5			18500	-11,7		
18800	-8,6			18800	-11,9		
19200	-8,7			19200	-12,1		
19500	-8,8			19500	-12,3		
19800	-8,9			19800	-12,5		
20100	-9,0			20100	-12,8		
20400	-9,1			20400	-13,0		
20700	-9,2			20700	-13,2		
21000	-9,3			21000	-13,4		
21400	-9,3			21400	-13,6		
21700	-9,4			21700	-13,8		
22000	-9,5			22000	-14,0		
22300	-9,5			22300	-14,2		
22600	-9,6			22600	-14,4		
22900	-9,6			22900	-14,6		
23200	-9,7			23200	-14,8		
23600	-9,7			23600	-15,0		
23900	-9,7			23900	-15,3		
24200	-9,7			24200	-15,5		
24500	-9,8			24500	-15,7		
24800	-9,8			24800	-15,9		
25100	-9,8			25100	-16,1		
25400	-9,8			25400	-16,3		
25700	-9,7			25700	-16,5		
26100	-9,7			26100	-16,8		
26400	-9,7			26400	-17,0		
26700	-9,7			26700	-17,2		
27000	-9,6			27000	-17,4		
27300	-9,6			27300	-17,6		
27600	-9,5			27600	-17,9		
27900	-9,5			27900	-18,1		
28300	-9,4			28300	-18,3		
28600	-9,4			28600	-18,6		
28900	-9,3			28900	-18,8		
29200	-9,2			29200	-19,1		
29500	-9,1			29500	-19,3		
29800	-9,0			29800	-19,6		
30100	-8,9			30100	-19,8		
30500	-8,8			30500	-20,1		
30800	-8,6			30800	-20,4		
31100	-8,5			31100	-20,6		
31400	-8,3			31400	-20,9		
31700	-8,2			31700	-21,2		
32000	-8,0			32000	-21,5		
32300	-7,9			32300	-21,8		
32700	-7,7			32600	-22,1		
33000	-7,5						

Interpolation is permitted for intermediate values

4.3.3.4.5 A330 900 - fuel curve graph per tank

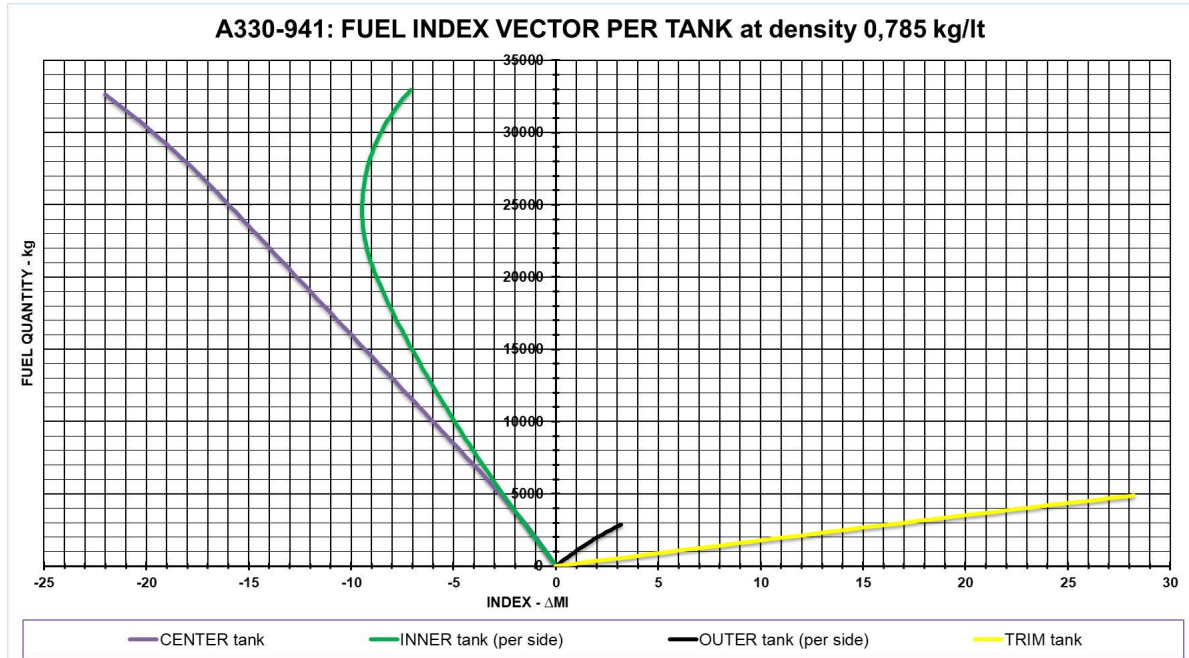





4.3.3.4.6 A330 900 - fuel table per tank

A330-941: FUEL INDEX VECTOR PER TANK at density 0,785 kg/lt

CENTER tank		OUTER tank (per side)		INNER tank (per side)		TRIM tank	
Density (kg/lt)	0,785	Density (kg/lt)	0,785	Density (kg/lt)	0,785	Density (kg/lt)	0,785
Weight (kg)	Δ M.I.	Weight (kg)	Δ M.I.	Weight (kg)	Δ M.I.	Weight (kg)	Δ M.I.
0	0,00	0	0,00	0	0,00	0	0,00
500	-0,23	200	0,17	500	-0,25	200	1,11
1000	-0,46	400	0,36	1000	-0,51	400	2,23
1500	-0,71	600	0,55	1500	-0,77	600	3,34
2000	-0,98	800	0,74	2000	-1,04	800	4,46
2500	-1,25	1000	0,94	2500	-1,31	1000	5,58
3000	-1,53	1200	1,15	3000	-1,57	1200	6,70
3500	-1,82	1400	1,36	3500	-1,83	1400	7,83
4000	-2,11	1600	1,57	4000	-2,09	1600	8,95
4500	-2,42	1800	1,80	4500	-2,34	1800	10,08
5000	-2,72	2000	2,03	5000	-2,59	2000	11,21
5500	-3,04	2200	2,28	5500	-2,84	2200	12,34
6000	-3,36	2400	2,54	6000	-3,09	2400	13,48
6500	-3,68	2600	2,80	6500	-3,33	2600	14,62
7000	-4,01	2800	3,08	7000	-3,57	2800	15,77
7500	-4,34	2865	3,17	7500	-3,81	3000	16,92
8000	-4,67			8000	-4,04	3200	18,09
8500	-5,00			8500	-4,27	3400	19,26
9000	-5,34			9000	-4,50	3600	20,43
9500	-5,67			9500	-4,72	3800	21,62
10000	-6,00			10000	-4,94	4000	22,81
10500	-6,33			10500	-5,16	4200	24,01
11000	-6,67			11000	-5,38	4400	25,22
11500	-7,00			11500	-5,59	4600	26,44
12000	-7,33			12000	-5,80	4800	27,66
12500	-7,66			12500	-6,01	4891	28,22
13000	-7,99			13000	-6,22		
13500	-8,33			13500	-6,42		
14000	-8,66			14000	-6,62		
14500	-8,99			14500	-6,82		
15000	-9,33			15000	-7,02		
15500	-9,66			15500	-7,21		
16000	-9,99			16000	-7,40		
16500	-10,32			16500	-7,59		
17000	-10,66			17000	-7,77		
17500	-10,99			17500	-7,94		
18000	-11,32			18000	-8,12		
18500	-11,65			18500	-8,29		
19000	-11,99			19000	-8,45		
19500	-12,32			19500	-8,61		
20000	-12,65			20000	-8,76		
20500	-12,98			20500	-8,90		
21000	-13,31			21000	-9,02		
21500	-13,65			21500	-9,13		
22000	-13,98			22000	-9,23		
22500	-14,31			22500	-9,31		
23000	-14,64			23000	-9,37		
23500	-14,98			23500	-9,41		
24000	-15,31			24000	-9,44		
24500	-15,64			24500	-9,46		
25000	-15,97			25000	-9,46		
25500	-16,31			25500	-9,44		
26000	-16,65			26000	-9,41		
26500	-17,00			26500	-9,36		
27000	-17,35			27000	-9,29		
27500	-17,72			27500	-9,22		
28000	-18,09			28000	-9,12		
28500	-18,47			28500	-9,00		
29000	-18,86			29000	-8,87		
29500	-19,26			29500	-8,72		
30000	-19,67			30000	-8,54		
30500	-20,09			30500	-8,36		
31000	-20,52			31000	-8,14		
31500	-20,96			31500	-7,90		
32000	-21,42			32000	-7,65		
32500	-21,89			32500	-7,37		
32625	-22,01			32970	-7,10		

Note: Interpolation is permitted for intermediate values

4.3.3.4.7 Example - A330 NON-STANDARD FUEL DISTRIBUTION FORM

A330 NON-STANDARD FUEL DISTRIBUTION FORM			
			
NOTE: The white sections shall be filled by Commander , the grey sections shall be filled by Load Controller .			
Flight / Date	/	A/C Registration	
From / To	/		
FUEL DISTRIBUTION		FUEL Δ M.I. CALCULATION	
TANK	FUEL QUANTITY (Kg)	-	+
Center	+ <input style="width: 80px;" type="text"/>	- <input style="width: 40px;" type="text"/> <input style="width: 40px;" type="text"/> <input style="width: 40px;" type="text"/>	
Inner Left	+ <input style="width: 80px;" type="text"/>	- <input style="width: 40px;" type="text"/> <input style="width: 40px;" type="text"/> <input style="width: 40px;" type="text"/>	
Inner Right	+ <input style="width: 80px;" type="text"/>	- <input style="width: 40px;" type="text"/> <input style="width: 40px;" type="text"/> <input style="width: 40px;" type="text"/>	
Outer Left	+ <input style="width: 80px;" type="text"/>		+ <input style="width: 40px;" type="text"/> <input style="width: 40px;" type="text"/> <input style="width: 40px;" type="text"/>
Outer Right	+ <input style="width: 80px;" type="text"/>		+ <input style="width: 40px;" type="text"/> <input style="width: 40px;" type="text"/> <input style="width: 40px;" type="text"/>
Trim	= <input style="width: 80px;" type="text"/>		+ <input style="width: 40px;" type="text"/> <input style="width: 40px;" type="text"/> <input style="width: 40px;" type="text"/>
BLOCK FUEL	<input style="width: 80px;" type="text"/>	=	=
TAXI FUEL *	<input style="width: 80px;" type="text"/>	=	=
		- <input style="width: 40px;" type="text"/> <input style="width: 40px;" type="text"/> <input style="width: 40px;" type="text"/>	+ <input style="width: 40px;" type="text"/> <input style="width: 40px;" type="text"/> <input style="width: 40px;" type="text"/>
			
			- <input style="width: 40px;" type="text"/> <input style="width: 40px;" type="text"/> <input style="width: 40px;" type="text"/>
TOTAL FUEL Δ M.I.		=	<input style="width: 40px;" type="text"/> <input style="width: 40px;" type="text"/> <input style="width: 40px;" type="text"/>
<input style="width: 40px;" type="text"/> <input style="width: 40px;" type="text"/> <input style="width: 40px;" type="text"/>		M.I.	← ACTUAL LITOW
<input style="width: 40px;" type="text"/> <input style="width: 40px;" type="text"/> <input style="width: 40px;" type="text"/>		%	← ACTUAL MACTOW
name	signature	name	signature
<input style="width: 80px;" type="text"/>	<input style="width: 80px;" type="text"/>	<input style="width: 80px;" type="text"/>	<input style="width: 80px;" type="text"/>

* For Manual calculation procedure only, the TAXI FUEL must be subtracted: 50% from Inner Left and 50% from Inner Right tank.

A330 NSFDF - Rev.4 MAR24

Fill in the form inserting the Total Take Off Fuel and the Fuel in each tank (gray area) subtracting the amount of Taxi Fuel from the inner tanks.

4.3.3.4.8 A350 900 - fuel curve graph per tank

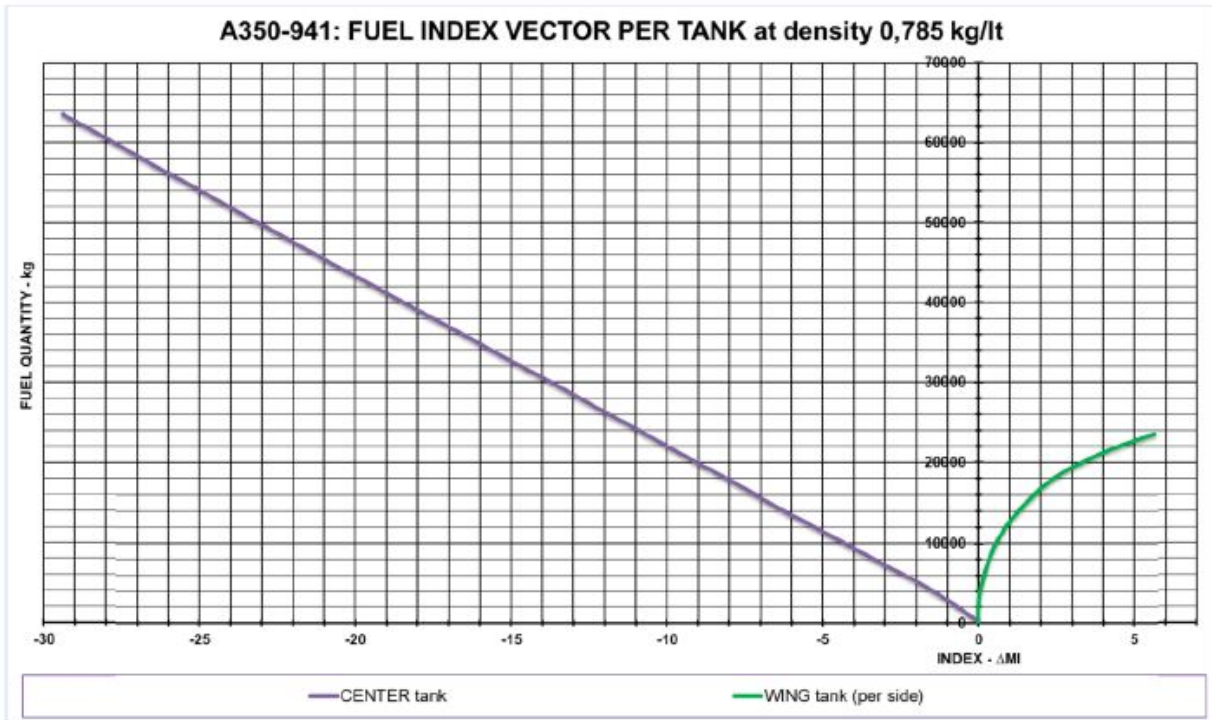

4.3.3.4.9 A350 900 - fuel table per tank

DATA APPLICABLE TO A350-941

A350-941: FUEL INDEX VECTOR PER TANK at density 0,785 kg/lit

CENTER tank				WING tank (per side)	
Density (kg/lit) 0,785				Density (kg/lit) 0,785	
Weight (kg)	Δ M.I.	Weight (kg)	Δ M.I.	Weight (kg)	Δ M.I.
0	0,0	32500	-15	0	0,0
500	-0,1	33000	-15,1	500	0,0
1000	-0,3	33500	-15,4	1000	0,0
1500	-0,5	34000	-15,6	1500	0,0
2000	-0,7	34500	-15,9	2000	0,0
2500	-0,8	35000	-16,1	2500	0,0
3000	-1,0	35500	-16,3	3000	0,0
3500	-1,3	36000	-16,6	3500	0,0
4000	-1,5	36500	-16,8	4000	0,1
4500	-1,7	37000	-17,0	4500	0,1
5000	-1,9	37500	-17,3	5000	0,1
5500	-2,1	38000	-17,5	5500	0,1
6000	-2,4	38500	-17,7	6000	0,2
6500	-2,6	39000	-18,0	6500	0,2
7000	-2,8	39500	-18,2	7000	0,2
7500	-3,1	40000	-18,5	7500	0,3
8000	-3,3	40500	-18,7	8000	0,3
8500	-3,6	41000	-18,9	8500	0,4
9000	-3,8	41500	-19,2	9000	0,4
9500	-4,0	42000	-19,4	9500	0,5
10000	-4,3	42500	-19,6	10000	0,6
10500	-4,5	43000	-19,9	10500	0,6
11000	-4,8	43500	-20,1	11000	0,7
11500	-5,0	44000	-20,3	11500	0,8
12000	-5,3	44500	-20,6	12000	0,9
12500	-5,5	45000	-20,8	12500	1,0
13000	-5,7	45500	-21,0	13000	1,1
13500	-6,0	46000	-21,3	13500	1,2
14000	-6,2	46500	-21,5	14000	1,3
14500	-6,5	47000	-21,7	14500	1,4
15000	-6,7	47500	-22,0	15000	1,5
15500	-6,9	48000	-22,2	15500	1,6
16000	-7,2	48500	-22,4	16000	1,8
16500	-7,4	49000	-22,7	16500	1,9
17000	-7,6	49500	-22,9	17000	2,1
17500	-7,9	50000	-23,1	17500	2,2
18000	-8,1	50500	-23,4	18000	2,4
18500	-8,4	51000	-23,6	18500	2,6
19000	-8,6	51500	-23,8	19000	2,8
19500	-8,8	52000	-24,1	19500	3,1
20000	-9,1	52500	-24,3	20000	3,3
20500	-9,3	53000	-24,5	20500	3,6
21000	-9,5	53500	-24,8	21000	3,9
21500	-9,8	54000	-25,0	21500	4,2
22000	-10,0	54500	-25,2	22000	4,5
22500	-10,2	55000	-25,5	22500	4,9
23000	-10,5	55500	-25,7	23000	5,2
23500	-10,7	56000	-25,9	23490	5,6
24000	-10,9	56500	-26,2		
24500	-11,2	57000	-26,4		
25000	-11,4	57500	-26,6		
25500	-11,6	58000	-26,8		
26000	-11,9	58500	-27,1		
26500	-12,1	59000	-27,3		
27000	-12,3	59500	-27,5		
27500	-12,6	60000	-27,8		
28000	-12,8	60500	-28,0		
28500	-13,0	61000	-28,2		
29000	-13,3	61500	-28,4		
29500	-13,5	62000	-28,7		
30000	-13,7	62500	-28,9		
30500	-14,0	63000	-29,1		
31000	-14,2	63500	-29,4		
31500	-14,4	63543	-29,4		
32000	-14,7				

Note: Interpolation is permitted for intermediate values

4.3.3.4.10 A350 NON-STANDARD FUEL DISTRIBUTION FORM

A350 NON-STANDARD FUEL DISTRIBUTION FORM			
 AIRWAYS			
NOTE: The white sections shall be filled by Commander , the grey sections shall be filled by Load Controller .			
Flight / Date	/	A/C Registration	
From / To	/		
FUEL DISTRIBUTION		FUEL Δ M.I. CALCULATION	
TANK	FUEL QUANTITY (Kg)	-	+
Center	+ <input style="width: 80%;" type="text"/>	- <input style="width: 20%;" type="text"/> <input style="width: 20%;" type="text"/> <input style="width: 20%;" type="text"/>	
Wing Left	+ <input style="width: 80%;" type="text"/>		+ <input style="width: 20%;" type="text"/> <input style="width: 20%;" type="text"/> <input style="width: 20%;" type="text"/>
Wing Right	= <input style="width: 80%;" type="text"/>		+ <input style="width: 20%;" type="text"/> <input style="width: 20%;" type="text"/> <input style="width: 20%;" type="text"/>
BLOCK FUEL	<input style="width: 80%;" type="text"/>	=	=
TAXI FUEL *	<input style="width: 80%;" type="text"/>		
		- <input style="width: 20%;" type="text"/> <input style="width: 20%;" type="text"/> <input style="width: 20%;" type="text"/>	+ <input style="width: 20%;" type="text"/> <input style="width: 20%;" type="text"/> <input style="width: 20%;" type="text"/>
			- <input style="width: 20%;" type="text"/> <input style="width: 20%;" type="text"/> <input style="width: 20%;" type="text"/>
TOTAL FUEL Δ M.I.		=	<input style="width: 20%;" type="text"/> <input style="width: 20%;" type="text"/> <input style="width: 20%;" type="text"/>
<input style="width: 20%;" type="text"/> <input style="width: 20%;" type="text"/> <input style="width: 20%;" type="text"/>		M.I.	← ACTUAL LITOW
<input style="width: 20%;" type="text"/> <input style="width: 20%;" type="text"/> <input style="width: 20%;" type="text"/>		%	← ACTUAL MACTOW
Commander		Load Controller	
name	signature	name	signature
<input style="width: 80%;" type="text"/>	<input style="width: 80%;" type="text"/>	<input style="width: 80%;" type="text"/>	<input style="width: 80%;" type="text"/>

* For Manual calculation procedure only, the TAXI FUEL must be subtracted: 50% from Wing Left and 50% from Wing Right tank.

A350 NSFDF - Rev.1 MAR24

Fill in the form inserting the Total Take Off Fuel and the Fuel in each tank (grey area) subtracting the amount of Taxi Fuel from the wing tanks.

 Volume II HLM	WEIGHT & BALANCE	4.3	Page 19
	LOADSHEET	Ed 2/20 apr 2022	

4.3.4 MANUAL LOADSHEET

4.3.4.1 Filling basic instructions

1. Destinations shall be indicated by the IATA 3 letter airport code.
2. Weights shall be expressed in whole Kilograms: decimal values equal to or above 0.5 shall be rounded off to the higher kilogram (e.g. 3.49 = 3, 3.5 = 4 e 3.51 = 4).
3. Deadload for destination shall be given net of the ULD tares.
4. An important item of the Loadsheets is the correct flight identifier.
A specific flight shall be identified as follows:
 - carrier code
 - line number
 - any letter suffix
 - stroke
 - date of origin of the flight (2 figures): the local departure day as scheduled by the station where the flight originates (e.g. XX611/02, XX1792/15, XXAF330/21, LHXX4300R/05, XX16/04).
5. The following data is published in the "Mass & Balance Data Sheet" of the relevant aircraft type:
 - conventional basic operating weight (BOW) per A/C type
 - conventional basic operating index (BOI) per A/C type
 - adjustment of the conventional BOW per each individual A/C
 - adjustment of the conventional BOI per each individual A/C
 - maximum zero fuel weight (MZFW)
 - maximum take-off weight (MTOW)
 - maximum landing weight (MLW)
 - corrections of the BOI for additional crew members, ULD tares, ballast fuel etc.
6. The following data is provided by the Captain or the Operations centre where existing:
 - any limitations relative to take-off weight (OTOW)
 - any limitations relative to landing weight (OLW)
 - take-off fuel (TOF)
 - trip fuel (TF)

The TF may also be obtained from the Company flight plan & log.

Note: The text of the load message consists of data entered in the shaded boxes of the manual Loadsheets. This data shall be entered immediately after aircraft departure.

Note: The total number of bags on board shall be manifested on SI field.

4.3.4.2 Manual Loadsheets elements identification

Address (es) 1

ITA AIRWAYS **LOADSHEET & LOADMESSAGE**
All weights in kilograms

From 2	Originator 3	Loadmg code LDM 3	Flight no. 4	A/C reg. marks 5	Version 6	Crew 7	Date of issuance 8
Basic operating weight 9	Adjustment for crew 10	Adjustment for pantry 11	Dry operating weight 13	Take-off fuel + 14	Operating weight 15	Zero fuel 16	Take-off 17
Maximum weight for: 18	Take-off fuel + 14	Allowed weight for take-off (lowest of a, b, c) 22	Operating weight 23	Allowed traffic load 24	Zero fuel 16	Take-off 17	Landing 18
Operating weight 15	Operating weight 23	Operating weight 23	Operating weight 23	Operating weight 23	Operating weight 23	Operating weight 23	Operating weight 23
Dest. 25	No. of passengers 26	Cab. 27	Total 28	Weight distribution 29	Weight distribution 30	Weight distribution 31	Remarks 49
Tr 32	B 33	C 34	M 35	1/ 36	2/ 37	3/ 38	4/ 39
Tr 32	B 33	C 34	M 35	1/ 36	2/ 37	3/ 38	4/ 39
Tr 32	B 33	C 34	M 35	1/ 36	2/ 37	3/ 38	4/ 39
Tr 32	B 33	C 34	M 35	1/ 36	2/ 37	3/ 38	4/ 39
ULD tare weight 54	Spare parts not included in container 55	ULD tare weight 54	Spare parts not included in container 55	ULD tare weight 54	Spare parts not included in container 55	ULD tare weight 54	Spare parts not included in container 55
Passenger weight 60	Total traffic load 66	Dry operating weight 68	Zero fuel weight 69	Take-off fuel 70	Take-off weight 71	Trip fuel 72	Landing weight 73
Passenger weight 60	Total traffic load 66	Dry operating weight 68	Zero fuel weight 69	Take-off fuel 70	Take-off weight 71	Trip fuel 72	Landing weight 73
Passenger weight 60	Total traffic load 66	Dry operating weight 68	Zero fuel weight 69	Take-off fuel 70	Take-off weight 71	Trip fuel 72	Landing weight 73
Passenger weight 60	Total traffic load 66	Dry operating weight 68	Zero fuel weight 69	Take-off fuel 70	Take-off weight 71	Trip fuel 72	Landing weight 73

Notes 1

Notes 2

1st copy: Captain 2nd copy: Station file 3rd copy: Any other use

 Volume II HLM	WEIGHT & BALANCE	4.3	Page 21
	LOADSHEET	Ed 2/20 apr 2022	

Reference Number	Heading	Entry Data	Notes
1	Address(es)	Priority and addresses of the load message (LDM)	
2	From	Station compiling the Loadsheets	IATA 3-letter airport code
3	Originator	LDM sender telex address	
4	Flight	Flight identifier	
5	A/C reg.	Aircraft registration marks	Hyphen must be omitted
6	Version	Cabin version - seats per class (passenger and combi aircraft) - ULD positions (cargo aircraft) preceded by "PS" identifier and load configuration (for widebody aircraft only)	
7	Crew	Crew (cockpit crew and flight attendants, separated by a stroke)	
8	Date of issuance	Local date of compilation of Loadsheets	
9	Basic operating weight	BOW	
10	Adjustment for crew	Additional crew members (with respect to those already included in BOW)	
11	Adjustment for pantry	Extra catering in the galleys	
12	other adjustment to BOW	Other corrections to the BOW (to be specified)	
13	Dry operating weight	Sum of entries 9+10+11+12	
14	Take-off fuel	TOF	
15	Operating weight	Sum of entries 13+14	
16	Maximum weight for: Zero fuel	MZFW	

 Volume II HLM	WEIGHT & BALANCE	4.3	Page 22
	LOADSHEET	Ed 2/20 apr 2022	

Reference Number	Heading	Entry Data	Notes
17	Maximum weight for: Take-off & Allowed weight for take-off (b)	MTOW	
18	Maximum weight for: Landing	MLW	
19	Trip fuel	TF	
20	Allowed weight for take-off (a)	The sum of entries 16+14	
21	Allowed weight for take-off (c)	The sum of entries 18+19	
22	Allowed weight for take-off (lowest of a, b, c)	RTOW is the lowest of the (b) and (a) values	
23	Operating weight	Entry 15, under RTOW	
24	Allowed traffic load	The difference between RTOW e and entry 15	
25	Dest.	Destination Station	Single or first destination
26	No. of passengers: Adults, Child, Infant		Number of passengers per weight category
27	(refer to entry 26)	Number of transit passengers for this destination	For flights in transit only
28	(refer to entry 26)	Number of originating passengers for this destination	
29	(refer to entry 26)	Number of departing passengers for this destination: the sum of entries 27+28 plus any LMC (see entries from 75 to 81). Passenger categories are separated by a stroke. If there are no passengers for a category 0 (zero) is entered	If there are no passengers, but only deadload 0/0/0 is entered. If there are neither passengers nor deadload the box is left blank

 ITA AIRWAYS Volume II HLM	WEIGHT & BALANCE	4.3	Page 23
	LOADSHEET	Ed 2/20 apr 2022	

Reference Number	Heading	Entry Data	Notes
30	Cab. bag.		Normally this is not applicable (this data is entered only if the weight of the hand baggage exceeds that allowed or if it is calculated separately)
31	(refer to entry 30)	Weight of hand baggage for this destination in transit from preceding stations	Only for flights in transit
32	(refer to entry 30)	Weight of originating hand baggage for this destination	
33	(refer to entry)	Weight of hand baggage departing for this destination: sum of entries 31+32 plus any LMC (see entries from 75 to 81). If there is no hand baggage 0 (zero) is entered, only if this item is considered for other destinations	If there are neither passengers nor deadload, this box is left blank.
34	Total: Tr	Weight of deadload for this destination in transit from previous stations	For flights in transit only
35	Total: B	Weight of originating registered baggage for this destination	
36	Total: C	Weight of originating cargo for this destination	
37	Total: M	Weight of originating mail for this destination	
38	Total: T	Weight of deadload in departure for this destination: sum of entries 34+35+36+37 plus any LMC (see entries from 75 to 81). If there is no deadload, 0 (zero) is entered	If there are neither passengers nor deadload the box is left blank.
39			Weight distributions of different load categories in the balance areas of the aircraft, using only areas containing load

 ITA AIRWAYS Volume II HLM	WEIGHT & BALANCE	4.3	Page 24
	LOADSHEET	Ed 2/20 apr 2022	

Reference Number	Heading	Entry Data	Notes
40		Weight distribution of deadload for this destination in transit from preceding stations	Only for flights in transit. The sum of data entered shall correspond to the "Total: Tr"(34)
41		Weight distribution of registered originating baggage for this destination	The sum of the data shall correspond to "Total: B" (35)
42		Weight distribution of originating cargo for this destination	The sum of entered data shall correspond to "Total: C" (36)
43		Weight distribution of originating mail for this destination	The sum of entered data shall correspond to "Total: M"(37)
44	1, 2,...	Weight distribution of the deadload in departure for this destination: the sum of entered data per balance area plus any LMC (see entries from 75 to 81)	Boxes concerning areas that do not contain load shall be left blank. The sum of data entered shall correspond to "Total: T"(38)
45		Seat-occupying passengers by class: F or P C or J Y	Number of passengers on board occupying seats per service class indicated, with specific reference to the version (entry 6) "Infants" shall not be counted.

 Volume II HLM	WEIGHT & BALANCE	4.3	Page 25
	LOADSHEET	Ed 2/20 apr 2022	

Reference Number	Heading	Entry Data	Notes
46	(refer to entry 45)	Number of seats occupied by transit passengers for this destination	For flights in transit only. The sum of data entered shall correspond to the total of passengers in transit (entry 27)
47	(refer to entry 45)	Number of seats occupied by originating passengers for this destination	The sum of data entered shall correspond to the total of originating passengers (entry 28)
48	PAX (refer to entry 45)	Number of seats occupied by passengers on departure for this destination: sum of 46+47 plus any LMC (see from 75 to 81).occupied seats as per class shall be separated by a stroke. If a specific class is not occupied, it must be indicated with number 0 (zero)	The sum of entered data shall correspond to the departing passenger total (entry 29*). If there are no departing passengers, the box is left blank. When flight is on single class aircraft, this information may be omitted.
49	Remarks	Any information regarding passengers with special needs and/or special loads on board for this destination	
50		Traffic information for the second destination	See entries 25 to 49
51		Traffic information for the third destination	
52		Traffic information for the fourth destination	
53		Traffic information for the fifth destination	
54		ULD tare total on board	Only for containerized aircraft

 ITA AIRWAYS Volume II HLM	WEIGHT & BALANCE	4.3	Page 26
	LOADSHEET	Ed 2/20 apr 2022	

Reference Number	Heading	Entry Data	Notes
55		ULD tare distribution in aircraft balance areas, using only areas containing ULDs	The sum of the data shall correspond to the weight entered as in entry 54
56	ULD tare weight	Spare parts not included in DOW/DOI	Weight of any extra spare parts
57		Weight distribution of any extra spare parts in the aircraft balance areas, using only areas concerned	the sum of data shall correspond to the weight entered as in entry 56
58		Weight of any other items to be considered as traffic load	See the DOW definition on previous pages
59		Weight distribution of any other items in the aircraft balance area, using relevant areas only	The sum of data shall correspond to the weight as in entry 58
60	(refer to entry 26)	Total number of passengers on board: sum of entries 27+28 of all destinations	
61		Total weight on board of deadload and items considered as traffic load: sum of entries 34+35+36+37 of all destinations plus entries 54+56+58	
62		Total weight distribution of deadload and items regarded as traffic load per balance area: sum of entries 40+41+42+43 of all destinations plus 55+57+59	The sum of entered data shall correspond to the total indicated at entry 61
63		Total number of seats occupied per class: sum of entries 46+47 of all destinations	The sum of data shall correspond to the total indicated in entry 60, excluding "infants"
64		Total weight of hand baggage on board: sum of entries 31+32 of all destinations	
65	Passenger weight	Weight of all passengers on board, calculated on the basis of data provided at entry 60	

 Volume II HLM	WEIGHT & BALANCE	4.3	Page 27
	LOADSHEET	Ed 2/20 apr 2022	

Reference Number	Heading	Entry Data	Notes
66	Total traffic load	Sum of entries 61+64+65	The TTL must never exceed the ATL (entry 24)
67	Underload	Difference between entries 24 and 66	
68	Zero fuel weight	AZFW: sum of entries 66+13	AZFW must never exceed MZFW (entry 16)
69	Take-off weight	ATOW: sum of entries 68+14	ATOW shall not exceed the maximum take-off weight (entry 17)
70	Landing weight	ALW: difference between entries 69 e 19	ALW shall on no condition exceed maximum landing weight (entry 18)
71	Seating conditions: Upper deck, Oa, Ob, ...	Distribution of passengers occupying seats in aircraft balance areas	The sum of entered data shall correspond to the total indicated in entry 60 excluding "infants"
72	Balance conditions: Dry operating index	DOI	
73	Balance conditions: Take-off ____% MAC	MACTOW	This data is calculated using the balance chart
74	Balance conditions: Zero fuel ____% MAC	MACZFW	
75	Last minute changes (LMC)		
76	Dest.	LMC destination	
77	Specification	Nature of LMC	
78	Balance area	Relevant balance area	
79	+/-	Loading (+)or unloading (-) identifier	

 ITA AIRWAYS Volume II HLM	WEIGHT & BALANCE	4.3	Page 28
	LOADSHEET	Ed 2/20 apr 2022	

Reference Number	Heading	Entry Data	Notes
80	Weight	LMC weight as indicated in entry 77	
81	Total	Resulting identifier (+ or -) and weight of all LMCs	A positive LMC value with respect to traffic load should not exceed the residual traffic load (entry 67)
82	Notes 1	Supplementary information to be transmitted with the load message	
83	Notes 2	Supplementary information not to be transmitted with the load message	
84	Prepared by	Signature of Weight and balance operator	
85	Approved by	Signature of aircraft Captain	

Manual Loadsheet Example

Address (es)		XXXXXXXX / YYYYYYY		ITA AIRWAYS		LOADSHEET & LOADMESSAGE		All weights in kilograms											
From	Originator	Loadmsg code LDM	Flight no.	A/C reg. marks	Version	Crew	Date of issuance												
SVQ	FCOVAAT		8239/03	E11XV	Y200	2.4	03 SEP 16												
Basic operating weight		49235		Maximum weight for:		Zero fuel	Take-off	Landing											
Adjustment for crew						70500		74500											
Adjustment for pantry				Take-off fuel		9500	Trip fuel	8200											
						a 80000	b 85000	c 80700											
Dry operating weight		49235		Allowed weight for take-off (lowest of a, b, c)															
Take-off fuel		9500		Operating weight		58735													
Operating weight		58735		Allowed traffic load		21265													
Dest.	No. of passengers			Cab. bag.	Total	Weight distribution								Seat-occupying passengers by class	Remarks				
	Adults	Child.	Inf.			1	2	3	4	5	6	0	F or P			Car	J	Y	
F	170	0	0		1676			838	838						0	0	170	HUM/1/150	
C					350	350													
O					400		400												
	170	0	0		2858	1/472	2/482	3/1002	4/902	5/	6/	0/					PAXI		
ULD tare weight		532		122		82		164		164									
Spare parts not included in DOW/DOI																			
Passenger weight		17000		2958		472		482		1002		1002		0		0		170	
Total traffic load		14230		Allowed traffic load		21265		SI		TTL BAGS 105									
Dry operating weight		49235		Underload		4027		101											
Zero fuel weight		66473		Last minute changes (LMC)										Seating conditions:					
Max.	70500	Dest.	FCO	Specification	BAGS	Balance area	4	±	-	Weight	100	Upper deck	Oa	Ob	Oc	Od	Oe		
Take-off fuel	9500											34	35	35	31	35			
Take-off weight	75973											Balance conditions:							
Max.	85000											Dry operating index 40,5							
Trip fuel	6500											Take-off 20,4 % MAC							
Landing weight	69473											Zero fuel 22,3 % MAC							
Max.	74500											Total - 100							
										Notes 2				Prepared by: <i>F. Felice Bianchi</i>					
														Approved by: <i>Colt Rom P. Pado Taini</i>					

Mod. 6703 zep-System Graphic srl

 Volume II HLM	WEIGHT & BALANCE	4.3	Page 30
	LOADSHEET	Ed 2/20 apr 2022	

4.3.5 EDP LOADSHEET

EDP Loadsheet is electronically generated by DCS, the document may be printed in paper or forwarded electronically via ACARS.

DCS systems different from the Company one shall be previously approved before being utilized.

Note For DCS system not setted to show the total number of bags on board, the Load Controller shall insert manually the information in SI field of LDM.

The integrity of Mass & Balance data and documentation generated by both the Company DCS and the DCS used by Ground Service Providers assisting ITA Airways flights, is carefully tested by Mass & Balance/DCS Depts Teams every six months.

4.3.5.1 EDP ACARS Loadsheet

ACARS system (Aircraft Communication Addressing and Reporting System) allow the transmission and receiving of messages between aircraft and ground stations.

The forward of ACARS Loadsheet is allowed in the stations if:

- ACARS system is operative.
- The station use Company DCS.
- Is accepted by local airport Authorities.

In stations where it is possible, it is expected the dispatch on board the Loadsheet exclusively via ACARS. Only in case of failure of the electronic transmission and after requesting confirmation to Captain on the ACARS system malfunction, a Loadsheet paper copy can be issued and sent on board.

If however, on stations covered by ACARS, the local authorities will ask for a paper Loadsheet copy signed by Captain, the station will have to send previously documentation, which specifies the legality of such request (regulation, communication, etc.), to the appropriate department for timely checks and for the subsequent issuing of an authorization LOA (Letter of Approval) in order to allow paper Loadsheet as an exception to Company procedure.

 ITA AIRWAYS Volume II HLM	WEIGHT & BALANCE	4.3	Page 31
	LOADSHEET	Ed 2/20 apr 2022	

The procedure to forward Loadsheet via ACARS shall be followed as described below:

ETD	ACTION
-20'	Captain on board initialize ACARS, checks system data (A/C Registration, Flight/ Data, Personal ID) and, in case of discrepancy, makes the necessary changes.
-15'	Deadline for Load controller to verify on ALTEA FM that the ACARS initialization has been correctly done. In case of failure, and if the Captain has confirmed a system malfunction, provide a paper copy of Loadsheet as per EDP Loadsheet procedure.
-7'	Load Controller finalizes Loadsheet (once final distribution has been checked via Loading Supervisor) and forwards on board the "Final Version".

After the document has been checked, the Captain may accept or reject it electronically. If document has been rejected the Captain shall provide to ask (via Loading Supervisor) a new Loadsheet notifying the reason of disapproval to Load Controller.

 Volume II HLM	WEIGHT & BALANCE	4.3	Page 32
	LOADSHEET	Ed 2/20 apr 2022	

4.3.5.2 EDP Loadsheet elements identification

EDP Loadsheet shall include the following elements:

SECTIONS	ELEMENTS IDENTIFICATION
Header	Document identification (LOADSHEET)
	Load Controller's identification code
	Name of the Captain
	Edition number
	Origin-Destination
	Carrier identification code (2 characters) + Flight number/Date
	Aircraft registration number
	Version
	Number of crew (Ckpt/Cbn)
	Local date of document issue (day/month/year)
	Local time of document issue
(*) Load Controller's identification code is the unique, traceable electronic code that the system automatically places on the document. This code (e.i. surname, serial number, alphanumeric, etc.) is associated with personal access credentials, assigned to authorized operators.	

 Volume II HLM	WEIGHT & BALANCE	4.3	Page 33
	LOADSHEET	Ed 2/20 apr 2022	

SECTIONS	ELEMENTS IDENTIFICATION
Weights	Dry Operating Weight (DOW)
	Zero Fuel Weight (ZFW)
	Maximum Zero Fuel Weight (MZFW)
	Take Off Fuel (TOF)
	Take Off Weight (TOW)
	Maximum Take Off Weight (MTOW)
	Trip Fuel (TIF)
	Landing Weight (LAW)
	Maximum Landing Weight (MLAW)
	Underload (UNDLD)
	Indicator showing which of the maximum weights is limiting the allowed traffic load (L)
	Passengers per gender (Male/Female/Child/Infant) NOTE - If the DCS is not able to enhance Male/Female/Child/Infant, Adult/Child/Infant shall be applied
	Passenger per class (PAD included; INF excluded)
Total of passengers on board (INF included) (TTL)	
Balance conditions	Dry Operating index (DOI)
	Loaded Index at Zero Fuel Weight (LIZFW)
	Indicators of balance conditions (MACZFW / MACTOW)
	Balance limits referred to ZFW (FWD - AFT)
	Passengers distribution on board
LMC	Last Minute Change NOTE - On paper EDP Loadsheet only
LDM	Load Distribution Message NOTE - The number of bag pieces shall be specified in the SI field of LDM

 Volume II HLM	WEIGHT & BALANCE	4.3	Page 34
	LOADSHEET	Ed 2/20 apr 2022	

The following elements are to be considered not mandatory and foreseen in the paper EDP Loadsheet only if allowed by DCS used on the Station, if different from Company DCS.

SECTIONS	ELEMENTS IDENTIFICATION
Header	Wording "ALL WEIGHTS IN KILOS"
Weights	LOAD IN COMPARTMENTS
	PASSENGER / CABIN BAG
	TOTAL TRAFFIC LOAD
CPM	Container & Pallet Message

EDP printed Loadsheet example

M99
LDS
EIEIH 61Q/14
LOADSHEET CHECKED APPROVED EDNO
ALL WEIGHTS IN KILOGRAMS 52150 1

FROM/TO FLIGHT A/C REG VERSION CREW DATE TIME
FOO JFK . 61Q/14 EIEIH J20P17Y213.2/4/5 14JAN18 1439

WEIGHT DISTRIBUTION
LOAD IN COMPARTMENTS 10227 1/1583 2/1800 3/3003 4/3459 5/382

PASSENGER/CABIN BAG 19678 156/83/4/2 TTL 245 CAB 0
JPY 17/16/2105000/Q/O
BLKD Q/Q/O

TOTAL TRAFFIC LOAD 29905
DRY OPERATING WEIGHT 125176
ZERO FUEL WEIGHT ACTUAL 155081 MAX 168000 L ADJ
TAKE OFF FUEL 55575
TAKE OFF WEIGHT ACTUAL 210656 MAX 230000 ADJ
TRIP FUEL 49280
LANDING WEIGHT ACTUAL 161376 MAX 180000 ADJ

LAST MINUTE CHANGES
BALANCE AND SEATING CONDITIONS DEST SPEC CL/OPT) - WEIGHT
DOI 50.9
LIZFW 64.5 MACZFW 31.4
LITOW 63.6 MACTOW 29.4
LILAW 61.2 MA CLAW 29.8

CABIN AREA
OA 17 OB 16 OC 112
OD 98
SEAT ROW TRIM

UNDERLOAD BEFORE LMC 12919 LMC TOTAL) -

CAPTAIN INFORMATION/NOTES
CAPTAIN NAME DEO BIANCHI
NOTOC NO/YES

BW 120130 BI 50.0
TAXI FUEL 525 RAMP TAXI WEIGHT ACTUAL 211181 MATW 230900
CG LIMITS LIZFW FWD 41.1 AFT 81.3
B/4492 C/4548 M/O E/O
PANTRY CODE D /4056
NO CHANGE
SI

LDM
61Q/14.EIEIH.J20P17Y213.2/4/5
-JFK.156/83/4/2.T10227.1/1583.2/1800.3/3003.4/3459.5/382
.PAX/17/16/210.PAD/Q/Q/2.IICE/11LPER/11L
SI
JFK FRE 4380 POS 0 BAG 251/ 4492 EIC 168 TRA
O
SI.

CPM
61Q/14.EIEIH.090
-11L/A KL3565AZ/JFK/123/CS.IICE.RFLPER-11R/N
-12P/PMC15248AZ/JFK/720/CS
-13P/PMC16722AZ/JFK/740/CS
-21P/PMC11815AZ/JFK/900/CS
-22P/PMC12344AZ/JFK/900/CS
-31P/PMC14545AZ/JFK/168Q/C1
-33L/A KLAZ/JFK/652/B1-33R/AKLAZ/JFK/67Q/B3
-41L/A KLAZ/JFK/751/BO-41R/AKLAZ/JFK/724/BO
-42L/A KLAZ/JFK/760/BO-42R/AKLAZ/JFK/313/B1
-43L/A KLAZ/JFK/438/B1-43R/AKLAZ/JFK/474/B1
-51.NIL
-52.NIL
-53/JFK/382/B/E.EICVR3
SI

AUTHORISED WEIGHTS USED FOR PASSENGERS CREW AND BAGGAGE

EDP ACARS Loadsheet example

M22
 AN .EI-EJH/FI 0610/MA2271
 - LOADSHEET 1439 EDN 1
 610/14 CKD 52150
 APPR AMEDEO BIANCHI
 FCO JFK EI-EJH J20P17Y 213 2/4/5

DOW 125176
 ZFW 155081 MAX 168000 L
 TOF 55575
 TOW 210656 MAX 230000
 TIF 49280
 LAW 161376 MAX 180000
 UNDL 12919
 PAX 156/83/4/2 TTL 245 CAB 0
 JPY 17/16/210 TTL 245

DOI 50.9
 LIZFW 64.5 MAZFW 31.4
 MACTOW 29.4
 PANTRY D /4056

SEAT DISTRIBUTION GA17 .06 16 .0C112 .0D98

ZFW OGL LIZFW FWD 41.1 AFT 81.3
 PAX OKED ON JUMP SEAT
 LMA AND CPT.S INFO BEFORE LMC
 -JFK.156/83/4/2.T10227.1/1583.2/1800.3/3003.4/3459.5/382
 .PAX/17/16/210.PAD/Q/Q/2.JCE/11LPER/11L
 SI
 JFK FRE 4380 POS 0 BAG 251/ 4492 EIC 168 TRA
 O
 SI.

-11L/A KL33565AZ/JFK/123/C3.JCE.RFL PER-11R/N
 -12P/PMC15248AZ/JFK/720/C3
 -13P/PMC16722AZ/JFK/740/C3
 -21P/PMC11815AZ/JFK/900/C3
 -22P/PMC12344AZ/JFK/900/C3
 -31P/PMC14545AZ/JFK/168Q/C1
 -33L/A KLAZ/JFK/652/B1-33R/AKLAZ/JFK/67Q/B3
 -41L/A KLAZ/JFK/751/BO-41R/AKLAZ/JFK/724/BO
 -42L/A KLAZ/JFK/760/BO-42R/AKLAZ/JFK/313/B1
 -43L/A KLAZ/JFK/438/B1-43R/AKLAZ/JFK/474/B1
 -51.NIL
 -52.NIL
 -53/JFK/382/B/E.EICVRS
 SI

 ITA AIRWAYS Volume II HLM	WEIGHT & BALANCE	4.3	Page 37
	LOADSHEET	Ed 2 Rev 17/27 jan 26	

4.3.6 REMOTE LOADSHEET ITA FLIGHTS

4.3.6.1 Introduction, mode and functions involved

The issuance of a remote Loadsheel, if a Station is unable or unauthorized to conduct this function, can be performed by the FCO Load Control in Centralized Load Control mode (hereinafter referred to as "CLC") or by another station trained, qualified and authorized by the carrier.

Depending on the agreements in place, the organization and the available DCS on the remote Station, the procedures for issuing the Loadsheel may be the following two:

- A. CLC DCS: applicable on stations where the Company DCS is available;
- B. CLC LDS: applicable in all other cases or as a "back up" of the CLC DCS.

The functions that must be present on the remote Station are:

- In case of CLC DCS procedure: Loading/Unloading Supervisor.
- In case of CLC LDS: Loading/Unloading Supervisor and Station CLC Coordinator. The two functions, on the remote Station, must be clearly designated and guaranteed by different operators, so that for every flight there is no ambiguity about responsibilities and activities.

The communication flow between the involved figures, are of main importance and crucial for the success of the entire process.

4.3.6.1.1 Communication method

For CLC DCS, the communication between the CLC and the Loading/Unloading Supervisor, and vice versa, shall take place through Altea FM Mobile (DCS FM) and, when required, via e-mail.

For CLC LDS procedure the communication between the CLC and the Station CLC Coordinator, and vice versa, shall be done via e-mail; upon receipt of each e-mail a confirmation reply shall be sent (i.e. "LIR received thank you").

Communication via telephone is accepted only in case of emergency and shall be used by applying the "Read Back" protocol, described below:

- a. the operator who makes the call, before communicating the data, confirms the use of the "Read Back";
- b. the operator receiving the call gives a confirmation response (i.e. "Ready for Read Back");
- c. the issuing operator communicates the data;
- d. the receiving operator, transcribed the data, repeats them to the issuing operator, in order to obtain confirmation of correct reception;
- e. the issuing operator replies, "OK confirmed" or, if it does not, re-transmits the data.

Apply the following rules in data communication:

- a. Numbers and letters shall be singularly pronounced. Use aeronautical alphabet (NATO phonetic alphabet) for letters.
- b. Always specify:
 - flight number/date;
 - aircraft registration;
 - departure station.

 Volume II HLM	WEIGHT & BALANCE	4.3	Page 38
	LOADSHEET	Ed 2 Rev 17/27 jan 26	

- c. Reporting of passengers figures:
 - specify ALL ADULTS or MALE-FEMALE/CHILD/INFANT according to flight type (CHARTER, SCHEDULED or FREE SEATING);
 - in case of MULTILEG or CIRCULAR flight, the distribution by cabin zone shall be indicated specifying the number of passengers for each destination.
- d. Reporting sequence of dead load:
 - from the most advanced (FWD) to the most backward (AFT) position.
- e. Reporting of ULD's loading:
 - specify: POS/COMMODITY/ULD ID CODE/PCS/NET WGT/DEST/RMKS-DG-SPECIAL LOADS if any;
 - all positions shall be reported, including empty ones (NO-FIT position).
- f. Reporting of bulk loading:
 - specify: POS/COMMODITY/PCS/NET WGT/DEST/RMKS-DG-SPECIAL LOADS if any;
 - all compartments shall be reported, including empty ones (NIL compartment).

 Volume II HLM	WEIGHT & BALANCE	4.3	Page 39
	LOADSHEET	Ed 2 Rev 17/27 jan 26	

4.3.6.2 CLC procedure

The implementation of the following procedure involves the use by the Loading/Unloading Supervisor of Altea FM Mobile for the communication and electronic transfer of data to the CLC in order to issue the Loadsheel.

4.3.6.2.1 Timing and activities

Timing from ETD		From	To	Action	Communication method/tool	Notes
Long Haul	Medium & Short Haul					
PRELIMINARY ACTIONS						
24h	24h	CLC	Departure Station	possible seat block in the cabin <u>to be carried out only for balancing purposes</u>	e.mail	The Departure station, while safeguarding commercial needs, will block the number of seats in the cabin areas indicated by the CLC.
3h30'	3h30'	Departure Station	CLC	sending ULD baggage details and segregation as required	e-mail	
3h	3h	Cargo Dept.at departure Station	CLC, Departure Station, ITA Supervision	sending estimated cargo figures and NOTOC (if any) in standard format (information in English)	e-mail, DCS FM	standard format for sending cargo figures: commodity / ULD number / pieces / net weight / destination / remarks -DG - special loads (IMP codes IATA)
2h	1h30'	Cargo Dept.at departure Station	CLC	enter final cargo figures	DCS FM	
2h	1h30'	CLC	Flight Dispatch	automatic EZFW sending control	DCS FM	
2h	1h30'	CLC	Departure Station	sending LIR (note: for wide body/c use graphical manuale form)	DCS FM via e-mail	
PREPARATION FOR DEPARTURE						
1h50'	1h20'	Departure Station	Loading/unloading team	conducting a flight briefing and delivering the related cargo documentation	face to face	
1h30'	N/A	ITA Supervision	Flight Dispatch, Captain, Departure Station, CLC	confirmation of JITR procedure application (ref. HLM 4.3.3.3 "Just in Time Refuelling" procedure (JITR))	e-mail, mobile phone	in case of "non-standard fuel distribution" (A330/A350) procedure 4.3.3.4 (HLM) is applied

LOADSHEET

Ed 2 Rev 17/27 jan 26

Timing from ETD		From	To	Action	Communication method/tool	Notes
Long Haul	Medium & Short Haul					
50'	50'	Departure Station	CLC	confirm aircraft registration, crew and fuel data (after receiving it from the Captain), ACARS operation	DCS FM	
FIGHT CLOSURE						
20'	20'	Departure Station	CLC	submission of the final fuel data	DCS FM	
15'	15'	Departure Station	CLC	finalization of the load and sending of the message 'ramp finalized, send final loadsheet'	DCS FM	
7'	7'	CLC	Captain, Departure Station	sending Loadsheet	ACARS, DCS FM	If ACARS is inoperative, send paper loadsheet and deliver to the Captain at - 5' from ETD
LMC						
by the closing of the doors (paper EDP Loadsheet)	by the closing of the doors (paper EDP Loadsheet)	Departure Station	CLC	transmission of changes to be made (ref. HLM 4.3.12 LAST MINUTE CHANGES (LMC))	face to face	
		Departure Station	Captain	update of the Loadsheet with LMC within structural and operational limits	DCS FM	
by the closing of the doors (ACARS EDP Loadsheet)	by the closing of the doors (ACARS EDP Loadsheet)	Departure Station	CLC	request to reopen flight	DCS FM	
		Departure Station	CLC	transmission of changes and finalization of the load	DCS FM	
		CLC	Captain	sending the new edition of the Loadsheet	ACARS, DCS FM	
DEPARTURE						
actions before the flight takes off	actions before the flight takes off	Departure Station	Network	insertion of Supplementary Information (SI) in operational messaging related to the load	DCS FM	

 Volume II HLM	WEIGHT & BALANCE	4.3	Page 41
	LOADSHEET	Ed 2 Rev 17/27 jan 26	

4.3.6.3 CLC LDS Procedure

The application of this procedure involves the use of the Load Distribution Sheet (LDS), in Excel format, which shall be used by the Station CLC Coordinator to transmit the flight data to CLC, in order to issue the Loadsheets.

The CLC, upon first contact with the Station CLC Coordinator, shall download, from the "Mass Balance documentation" folder of the Intranet, and send:

- the LDS form;
- the chapter REMOTE LOADSHEET ITA FLIGHTS;
- the paragraph CLC LDS PROCEDURE.

In case the Station CLC Coordinator needs to communicate a variation of the previously transmitted data, it shall send the updated LDS form, indicating in the e-mail subject which section has been modified: i.e. "LDS Flight /Date PASSENGERS DATA CHANGED" or "LDS Flight/Date DEAD LOAD DATA CHANGED".

In case of:

- electronic compilation, update the LDS module, replacing the incorrect data with the correct one;
- manual compilation, update the LDS module, by crossing out the wrong data and rewriting the correct data since incorrect data overwriting is not accepted.

Note: if all forwarding communication systems of Loadsheets fail, the CLC shall provide to the Captain, via telephone (see 4.3.6.1.1 Communication method), all necessary data to complete the manual Loadsheets.

In case the CLC fails to contact the Captain, the data shall be provided by the Station CLC Coordinator.

In case of Last Minute Change (LMC), the Station CLC Coordinator shall:

- A. report changes in the LMC box of the last LDS form already transmitted, without updating the data in other sections;
- B. forward the updated LDS form indicating in the message object "LDS Flight/Date LMC".

After flight departure, the Station CLC Coordinator shall send to the CLC a scan of the following documents:

1. LIR filled and signed in all fields;
2. Paper EDP or manual Loadsheets, signed by the Captain (only in case of ACARS failure);
3. The first 2 pages of the Operational Flight Plan (OFF) signed by the Captain or Summary Fuel Page;
4. NOTOC (if applicable) compiled and signed in all expected fields. Once received the documentation, the CLC shall send the messages and file flight documents.

Note: If a remote Station operates scheduled flights, flight documents shall be archived locally.

 Volume II HLM	WEIGHT & BALANCE	4.3	Page 42
	LOADSHEET	Ed 2 Rev 17/27 jan 26	

4.3.6.3.1 Station CLC Coordinator function

This function, which is necessary only for this procedure application, in order to operate, shall satisfy the following:

- **prerequisite:**
 - knowledge of spoken and written english language;
- **training requirements:**
 - activities during aircraft turnaround;
 - familiarization with ITA aircraft fleet;
 - general principles of Load Control.
- **responsibility:**
 - guarantee and coordinate, according to the scheduled timing, the communication flow with the CLC function and between the CLC function and the Loading/Unloading Supervision function, for all the information that may have an impact on the issuing of the Loadsheets (i.e. problems with the underload, non-standard fuel distribution A330, load limitations, etc.);
 - communicate with the CLC, always using english language;
 - be able to contact or be reached by the CLC at any time (including by e-mail and/or telephone). If necessary, it shall guarantee communication between the Flight Deck and the CLC;
 - in the event of ACARS malfunction, it shall ensure the printing and delivery of the EDP paper Loadsheets to the Captain.

 Volume II HLM	WEIGHT & BALANCE	4.3	Page 43
	LOADSHEET	Ed 2 Rev 17/27 jan 26	

4.3.6.3.2 Timing and activities

Timing from ETD		Loadsheet	CLC	Station CLC Coordinator	
Long Haul	Medium & Short Haul				
3h30'	3h		Contacts the Station by e-mail sending the message "WE ARE ON LINE" attaching: - the HLM chapter "REMOTE LOADSHEET ITA FLIGHTS (excluded the paragraph CLC procedure")		
3h	2,5h			Sends an e-mail to CLC with provisional figure for Pax, Bags, Cargo, Mail and NOTOC (if applicable). Informs CLC about any delays (i.e. airport delays, techniques, weather, etc.) and confirms ACARS transmission system is operative.	
2h30'	1h30'		Sends LIR (only for Wide Body aircraft use the manual form)		
1h30'	N/A		Verifies with the Station the applicability of the Just In Time Refuelling procedure (HLM 4.3.3.3 "Just in Time Refuelling" procedure (JITR))		
FLIGHT CLOSURE					
45'	35'			Sends to CLC the Excel file of the LDS form completed with all final figures	
da 45' a 7'	da 35' a 7'		ACARS	Sends on board the EDP Loadsheet via ACARS.	
da 45' a 15'	da 35' a 15'		HARD COPY	Sends the paper or manual EDP Loadsheet (if ACARS is inoperative).	
LAST MINUTE CHANGES (LMC)					
BY DOORS CLOSING				Sends to CLC the Excel file of the LDS form with the LMC section filled in, without updating the data already present in other sections of the previously forwarded form.	
			Replies "OK LMC ACCEPTED" and sends the final Loadsheet or provides by e-mail the new MACTOW and MACZFW values to update the previously sent Loadsheet.		
			or		
			Replies "LMC OUT OF LIMITS" and send new instructions.		
				Follows the instructions and sends confirmation to CLC.	
			Sends the final Loadsheet		

4.3.6.3.3 LDS - Example

>> **A319 - A320 - A220** <<

LOAD DISTRIBUTION SHEET



Fill the form and send back to FCO Load Control: fcoloadcontrol@airporthandling.it; FCO.RIT.LoadControl@airporthandling.it
 Supervisor on Duty Load Control: +39 06 6595 60374, +39 06 6595 60373
 Supervisor on Duty - HCC: +39 06 6595 60380 e-mail: FCO.Supervisor.HCC@airporthandling.it

The e-mail address of the Load Controller will be communicated by Supervisor before the operations start

FLIGHT DATA												
<u>FLIGHT N° / DATE</u>	/	<u>A/C REGISTRATION</u>										
<u>ROUTING</u>	/											
<u>CREW</u>		<u>CABIN VERSION</u>	<table border="1" style="border-collapse: collapse;"> <tr> <td style="width: 50%; text-align: center;">C</td> <td style="width: 50%; text-align: center;">Y</td> </tr> <tr> <td style="height: 20px;"></td> <td style="height: 20px;"></td> </tr> </table>	C	Y							
C	Y											
<u>FUEL FIGURES</u> <small>(all weights in Kgs)</small>	<table border="1" style="border-collapse: collapse;"> <tr> <td><u>BLOCK FUEL</u></td> <td style="width: 50px;"></td> </tr> <tr> <td><u>TRIP FUEL</u></td> <td style="width: 50px;"></td> </tr> <tr> <td><u>TAXI FUEL</u></td> <td style="width: 50px;"></td> </tr> </table>	<u>BLOCK FUEL</u>		<u>TRIP FUEL</u>		<u>TAXI FUEL</u>		<table border="1" style="border-collapse: collapse;"> <tr> <th style="background-color: #cccccc;">NOTES</th> </tr> <tr> <td style="height: 20px;"></td> </tr> <tr> <td style="height: 20px;"></td> </tr> </table>		NOTES		
<u>BLOCK FUEL</u>												
<u>TRIP FUEL</u>												
<u>TAXI FUEL</u>												
NOTES												

PASSENGERS DATA									
Legenda: A (Adults) - M (Adult Male) - F (Adult Female) - CHD (Child) - I (Infant).									
SEATING CONDITIONS	CABIN ZONE	DEST	TOT. PAX NO	A	M	F	CHD	I	
A319 - A320 - A220	0A								
	0B								
	0C								
		DEST	TOT. PAX NO	A	M	F	CHD	I	
	TTL PAX On Board								

>> **A330 - A350** <<

LOAD DISTRIBUTION SHEET



Fill the form and send back to FCO Load Control: fco.loadcontrol@airporthandling.it; FCO.RIT.LoadControl@airporthandling.it

Supervisor on Duty Load Control: +39 06 6595 60374, +39 06 6595 60373

Supervisor on Duty - HCC: +39 06 6595 60380 e-mail: FCO.Supervisor.HCC@airporthandling.it

The e-mail address of the Load Controller will be communicated by Supervisor before the operations start

FLIGHT DATA					
<u>FLIGHT N° / DATE</u>	/		<u>A/C REGISTRATION</u>	/	
<u>ROUTING</u>	/		<u>CABIN VERSION</u>	J	P
<u>CREW</u>	/	/		Y	/
<u>FUEL FIGURES</u> <small>(all weights in Kgs)</small>	<u>BLOCK FUEL</u>	/	NOTES		
	<u>TRIP FUEL</u>	/			
	<u>TAXI FUEL</u>	/			

PASSENGERS DATA									
Legenda: A (Adults) - M (Adult Male) - F (Adult Female) - CHD (Child) - I (Infant).									
A330 - A350	SEATING CONDITIONS	CABIN ZONE	DEST	TOT. PAX NO INFANT	A	M	F	CHD	I
	0A								
	0B								
	0C								
	0D								
		DEST	TOT. PAX NO INFANT	A	M	F	CHD	I	
TTL PAX On Board									

>> back <<

LOAD DISTRIBUTION SHEET



PLEASE FILL THE FORM AND HAND OVER TO CAPTAIN

DEAD LOAD DATA (all weights in Kgs)							
<u>FLIGHT N° / DATE</u> <input style="width: 100%;" type="text"/>	<u>CARGO</u>	<u>TOT. NET WEIGHT</u> <input style="width: 100%;" type="text"/>	<u>MAIL</u>	<u>TOT. NET WEIGHT</u> <input style="width: 100%;" type="text"/>			
<u>A/C REGISTRATION</u> <input style="width: 100%;" type="text"/>			↓	B	I	TOT.	
	TOT BAGS LOADED <small>(net weight)</small>	PCS	<input style="width: 100%;" type="text"/>	<input style="width: 100%;" type="text"/>	<input style="width: 100%;" type="text"/>	<input style="width: 100%;" type="text"/>	
		WGT	<input style="width: 100%;" type="text"/>	<input style="width: 100%;" type="text"/>	<input style="width: 100%;" type="text"/>	<input style="width: 100%;" type="text"/>	
FINAL LOAD DISTRIBUTION (all positions have to be reported, NO-FIT included)							
POS	COMMODITY	PCS	NET WGT	DEST	RMKS / DG / SPECIAL LOADS		
Legenda Commodity	BJ Priority Bag	BS Short Bag	BY Local Bag	BT Transfer Bag	BR Rush Baggage	BG Baggage Gate	D Crew Bag
	C Cargo	M mail	Q Company Mail	E Equipment	N Nil		

LAST MINUTE CHANGE (LMC)				
DEST	SPECIFICATION	CL / CABIN ZONE / CMPT	+/-	WEIGHT
TOTAL LMC				

 ITA AIRWAYS Volume II HLM	WEIGHT & BALANCE	4.3	Page 47
	LOADSHEET	Ed 2 Rev 17/27 jan 26	

4.3.6.3.4 LDS - Filling instructions

The "Load Distribution Sheet" (LDS) form consists of two pages and four sections.

Page 1 (front) shows the FLIGHT DATA and PASSENGERS DATA sections.

Page 2 (back) shows the DEAD LOAD DATA and LAST MINUTE CHANGE (LMC) sections. The LDS form shall be filled in electronic mode; manual compilation can be used only as "back-up" method.

It is mandatory to fill in the yellow fields in the LDS according to flight or aircraft type (i.e. Charter or Scheduled Flight, number of destinations, number of loading positions).

FLIGHT DATA section

The section, for all flight types, shall always be filled and sent by the Station CLC Coordinator to CLC. Yellow unused ROUTING fields shall be left blank.

PASSENGERS DATA Section

The remote Station that accepts passengers with the DCS SABRE (Interact), may not fill in the "PASSENGERS DATA" section of the form as the CLC is able to retrieve automatically data from the system.

In case of MULTILEG or CIRCULAR flight, the distribution by cabin zone shall be indicated by specifying the number of passengers for each destination.

In case of CHARTER FLIGHT, fill in the columns: A (All Adults), CHD (Child) and I (Infant).

In case of SCHEDULED FLIGHT, fill in the columns: M (Adult Male), F (Adult Female), CHD (Child) and I (Infant).

In case of FREE SEATING, fill in the columns (for each destination): A (All Adults), CHD (Child) and I (Infant).

The rows of unused destinations must be left empty.

DEAD LOAD Section

In FINAL LOAD DISTRIBUTION, all aircraft positions/compartments shall be reported.

Unnecessary FINAL LOAD DISTRIBUTION rows shall be left blank.

In the COMMODITY column, the following codes shall be used:

- **BJ** - PRIORITY LOCAL.
- **BY** - ECONOMY LOCAL.
- **BT** - TRANSIT BAGGAGE.
- **BH** - HUB BAGGAGE. Dedicated ULD (Tail to Tail or Groups)
- **BG** - GATE BAGGAGE (bagaglio collected at gate).
- **BR** - RUSH BAGGAGE.
- **D** - CREW BAGGAGE

 Volume II HLM	WEIGHT & BALANCE	4.3	Page 48
	LOADSHEET	Ed 2 Rev 17/27 jan 26	

Additional Codes:

- C** - Cargo
- E** - Company Equipment
- M** - Mail
- Q** - Company Mail

LAST MINUTE CHANGE (LMC) Section

In case of LMC, all row fields shall be filled.

Changes must be reported in LMC table without updating the data already filled in the other sections of the previously forwarded form.

 Volume II HLM	WEIGHT & BALANCE	4.3	Page 49
	LOADSHEET	Ed 2 Rev 17/27 jan 26	

4.3.7 CODES TO BE USED ON LOADSHEET

Codes must be used on Loadsheets to identify those types of load which require special handling and/or treatment and shall be compliant with Company requirements.

With reference to the indications of Dangerous Goods may:

- have more than one class of danger.
Only information relating to primary danger should be entered in the Loadsheets, unless the secondary danger consists in RHF, RIS or RPB.
- and/or be classified as CAO (Cargo Aircraft Only).

This additional restriction shall be entered, in both cases, on the Loadsheets and information shall always be complete.

Additional codes may be entered in LDM and/or CPM messages in the following ways:

- in the "Remarks" per destination
(e.g. RSC/23P.RHF RSC/23P.CAO RSC/23P.RHF.CAO
or
RSC/RHF/23P RSC/CAO/23P RSC/RHF/CAO/23P)
- in the "Supplementary Information" (SI) field, preceded by the destination, where necessary
(e.g. JFK.RSC/RHFRSC/CAO - JFK.RSC/RHF/CAO)

EAT, LHO and PER shipments may be refrigerated with dry ice (ICE) or cryogenic liquid (RCL). In these instances EAT, LHO or PER information should always be complete, ICE and RCL articles are classified as "dangerous goods".

The additional ICE and RCL codes may be entered as indicated above.

The codes shown below must be used for ITA.

 Volume II HLM	WEIGHT & BALANCE	4.3	Page 50
	LOADSHEET	Ed 2 Rev 17/27 jan 26	

ACE	Aircraft engine
ACT	Electrical active temperature control system or container (no specific temperature setting)
AOG	Aircraft on Ground (urgent spare parts for grounded aircraft)
AVI	Live animals loaded in hold
	E.g. AVI/11P
AVX	Day old chicks
BAL	Ballast
BED	Stretcher installed followed by the number of seats blocked for the stretcher arrangement and the number and class of seats occupied by these passengers (invalid and/or accompanying).
	E.g. BED/6/1Y BED/9/OY
BEH	Stretcher loaded in compartment
BIG	An item that requires particular handling and/or equipment for loading and unloading operations due to its size and/or weight through being loaded onto two or more pallets, followed by the forward and aft load positions occupied by the item and the weight. E.g. BIG/CE/3500 BIG/FG/1600 BIG/CRDR/850 BIG/ERFR/2740 OHG information should be entered where necessary
BLF	Fuel as ballast
BUP	Bulk unitization program
CAO	Cargo Aircraft Only Note: CAO is only an additional restriction for dangerous goods: when it applies the CAO code should be added to the information requested on the particular type of dangerous goods to be loaded
CAT	Cargo attendant on cargo aircraft followed by the number of attendants E.g. CAT/1
COL	Perishable requiring a temperature between +2 and +8 °C for transport and storage
COM	Company mail
CRT	Perishable requiring a temperature between +15 and +25 °C for transport and storage
CSB	"Cargo seat bags" followed by the number of containers, the number of seats blocked and their class E.g. CSB/2/5Y Note: CSB information shall not be entered for mail flights
CSU	Catering equipment and food supply not galley loaded

 Volume II HLM	WEIGHT & BALANCE	4.3	Page 51
	LOADSHEET	Ed 2 Rev 17/27 jan 26	

DIP	Diplomatic mail
EAT	Foods for human consumption
EIC	Equipment in compartment (material not on manifest and not included in the "Dry Operating Weight", to be disembarked at a station) Note: This may include: spare parts, catering transported in the cargo hold, load accessories, ULDs and Cargo Seat Bags being sent to a station, a stretcher transported in the cargo hold, etc. Items excluded are: ULDs which are part of the aircraft's basic equipment, restraint equipment used on the ULDs, etc.,
ELD	Stacked pallet
ELI	Lithium Ion Batteries Excepted
ELM	Lithium Metal Batteries Excepted
ERT	Perishable requiring a temperature between +2 and +25 °C for transport and storage
FCY	(or FY.CY.Y) Passengers per class followed by the number of seats occupied in the classes of service
FIL	Undeveloped films
FKT	Extra spare parts (material not on manifest and not included in the "Dry Operating Weight", not destined for a station and therefore not to be disembarked)
FRG	Non-booked "non-revenue" goods
FRI	Frozen goods subject to veterinary / phytosanitary inspection
FRO	Frozen goods
HEA	Heavy items over 150 Kg Note: HEA information should not be entered when items are loaded on ULDs
HEG	Hatching eggs
HUM	Human remains in coffins Note: HEA information shall not be entered for coffins weighing more than 100 Kg
ICE	Dry ice - solid carbon dioxide - may be used as refrigeration for EAT, LHO and PER shipments: where this is the case, the ICE code shall be added to the required information for EAT, LHO or PER shipments loaded
LHO	Live Human Organ
MAG	Magnetized Material
NIL	no items loaded - neither passengers nor deadload E.g. NIL

 Volume II HLM	WEIGHT & BALANCE	4.3	Page 52
	LOADSHEET	Ed 2 Rev 17/27 jan 26	

- OBC** Onboard courier baggage
- OHG** Item that protrudes from the pallet/s on which it is loaded with overhang over adjacent forward and/or aft load positions
followed by the forward and aft load position/s the item rests on, the adjacent forward and/or aft load position/s overhung by the protruding parts and by the length of overhanging parts expressed in centimetres
E.g. OHG/D/C75/E30 OHG/F/E84 OHG/G/H47 OHG/ER FR/DR90/GR12S
Where necessary BIG information should also be entered
- OXY** Oxygen therapy apparatus installed
followed by the number of seats blocked by the apparatus installation, the number of passengers, if any, occupying these seats and the class
E.g. OXY/3/JC OXY/3/OC OXY/1/1Y
- PAD** Passengers available for disembarkation
followed by the number of seats occupied in each class, with specific reference to the number of classes as indicated in the "version" box
E.g. PAD/0/3/4 PAD/0/1 PAD/2
- PAS** Temperature sensitive pharmaceuticals
- PAX** Passengers per class
followed by the number of seats occupied in the classes of service
- PEB** Live animals for human consumption
- PEF** Perishable fresh Flowers
- PER** Perishable goods (other than PEF-PES)
- PES** Perishable fresh Fish
- PIL** Pharmaceutical products
- PPM** Medium temperatures setting: 12-18 C°
- PWG** Pallet side extensions
- RCL** Cryogenic liquids
Note: May be used as refrigeration for LHO and PER shipments: where this is the case the RCL code should be added to the information required for LHO or PER shipments embarked
- RCM** Corrosive
- RCX** Explosives cat. 1.1, 1.2, 1.3, 1.4f, 1.5
- REX**
RGX
RCX Explosives (for specifics see DGR Manual)
- REQ** Dangerous Goods in Excepted Quantities

 Volume II HLM	WEIGHT & BALANCE	4.3	Page 53
	LOADSHEET	Ed 2 Rev 17/27 jan 26	

RFG	Flammable gas
RFL	Flammable liquid
RFS	Flammable solids
RFW	Dangerous when wet
RIS	Infectious substances Note: RIS may also be an additional danger to some dangerous goods: when this is the case, the RHF code should be added to information required about the particular dangerous goods embarked.
RMD	Miscellaneous
RNG	Non Toxic gas
ROP	Organic Peroxide
ROX	Oxidizer
RPB	Toxic substances Note: RPB may also be an additional danger to some dangerous goods: when this is the case, the RHF code should be added to information required about the particular dangerous goods embarked
RPG	Toxic Gas
RSB	Polymeric Beads
RSC	Substances susceptible to spontaneous combustion
RXB	Explosives with 1.4B classification
RRY	Radioactive materials, categories II and III Note: transport index should be shown by a whole number: decimal numbers should be rounded up to the next whole number (e.g. 0.6=1, 7.2=8 e 43.5=44) When several items of radioactive material are stowed in the same load position, the transport index to be entered on the Loadsheets and in the load message should be the total of the transport indexes of all radioactive material items loaded in the position.
RRW	Radioactive materials, category I
SDA	Same day courier cargo
SEC	Objects taken from passengers for security reasons Note: following check-in followed by the number of items and load position (not accessible during the flight)
SLJ	Joker business
SMO	Shock sensitive good

 Volume II HLM	WEIGHT & BALANCE	4.3	Page 54
	LOADSHEET	Ed 2 Rev 17/27 jan 26	

- SOC** Seats blocked for/occupied by cabin load followed by the number of seats blocked/occupied per class, with special reference to the number of classes as indicated in the "version" box
- UCB** Unaccompanied courier baggage
- WBD** Dry battery wheelchair
- WBL** Lithium battery wheelchair
- WBW** Wet battery wheelchair
- WBX** Removable Lithium battery wheelchair
- WEA** Weapon and ammunitions followed by the number of items and the load position (non accessible during the flight)
- XCP** Premium Express Cargo
- XCS** Express Cargo
- XOM** Super Express Cargo
- XOS** Super Express Cargo - Small packages
- XRC** Seats occupied by/blocked for on-duty crew members (counted in the "crew" box) followed by the number of seats occupied/blocked per class with specific reference to the number of classes as indicated in the "version" box
E.g. XCR/0/1/3 XCR/2/0 XCR/1
Note: On-duty crew members occupying passenger seats are included in the "Basic Operating Weight & Index"

 Volume II HLM	WEIGHT & BALANCE	4.3	Page 55
	LOADSHEET	Ed 2 Rev 17/27 jan 26	

4.3.8 FREE SEATING

In case of seats on board not assigned and a "Free Seating Flight" mode is used, Load Controller shall:

1. distribute the passengers in cabin zones to ensure aircraft is balanced. If possible, distribute passengers uniformly in all zones of the cabin, respecting the relevant service classes;
2. insert the note "FREE SEATING – VERIFY SEATING ALLOCATION" so that it appears on the Loadsheel. If you are using the Company DCS, the note shall be entered in the SI field in the LDM;
3. inform the Captain that the flight is a "Free Seating Flight" and the passenger distribution must be respected on board as reported in the Loadsheel.

4.3.9 FORCED PAX DISTRIBUTION

For commercial reasons passengers must be allowed to choose their seats.

However, in case all pre-operational aircraft balancing actions are inadequate, it is necessary to change the distribution of passengers defined at the time of acceptance.

Load Controller shall:

1. move enough passengers to ensure that the aircraft is balanced, respecting the relevant service classes (this procedure is not allowed to achieve a better balancing value in terms of MAC when the CG is already within permitted limits);
2. insert the note "FORCED PAX DISTRIBUTION - VERIFY SEATING ALLOCATION" so that it appears on the Loadsheel. If you are using the Company DCS, the note shall be entered in the SI field in the LDM;
3. inform the Captain that, for balancing reasons, the passengers distribution defined at the acceptance phase has been changed and the seating reported in the Loadsheel must be respected.

4.3.10 PASSENGER DISTRIBUTION ON MULTI LEG OR CIRCULAR FLIGHT

In case of multi leg or circular flight, in order to verify the correspondence between the actual seating on the aircraft and the one on the Loadsheel, the Load Controller shall insert the note "MULTI LEG FLIGHT - VERIFY SEATING ALLOCATION" so that it appears on the document. If you are using the Company DCS, the note shall be entered in the SI field in the LDM.

If the "Forced Pax Distribution" procedure is required (see 4.3.9 FORCED PAX DISTRIBUTION), the note "MULTI LEG FLIGHT - VERIFY SEATING ALLOCATION" shall be omitted from the Loadsheel and replaced with the proper note.

 Volume II HLM	WEIGHT & BALANCE	4.3	Page 56
	LOADSHEET	Ed 2 Rev 17/27 jan 26	

4.3.11 STRETCHER ON BOARD

The stretcher for STCR passenger always travels together with its container.

The stretcher-container equipment shall be reported by the Load Controller on the Loadsheets as follows:

1. In case of stretcher installed in cabin and container loaded into the cargo hold, insert:
 - Stretcher weight 45 Kg, BED code,
 - Container weight 25 Kg, EIC code, note "Stretcher box" in the SI field of LDM message.
2. In case of stretcher and container loaded into the hold, insert:
 - Stretcher + container weight 70 Kg, BEH code.

 Volume II HLM	WEIGHT & BALANCE	4.3	Page 57
	LOADSHEET	Ed 2 Rev 17/27 jan 26	

4.3.12 LAST MINUTE CHANGES (LMC)

The wording "Last Minute Change" indicates all variations that may occur after the Loadsheet is issued.

Before off-block, any change must be immediately communicated to the Captain and to the responsible person who is issuing the Loadsheet for appropriate checks and updates. The change shall be handled as follows:

- ACARS Loadsheet: for all changes, a new issue of the Loadsheet shall be carried out.
- Paper Loadsheet (EDP or manual): the only changes allowed are those related to the commercial load, DOW, and fuel which will be reported in the LMC field. When LMCs are made on the Loadsheet, it's necessary to make sure that:
 1. the total weight of a positive LMC does not exceed the "Underload" value shown on the Loadsheet;
 2. structural limitations (i.e. compartment) are not exceeded;
 3. the Center of Gravity (CG) remains within the safety limits shown on the balance chart;
 4. the new values of MACZFW and MACTOW are shown on the Loadsheet.

A new Loadsheet shall always be issued and provided in the following cases:

- if the changes affect the fuel;
- on Captain's request;
- anytime LMC exceed at least one of the following values:

A/C type	Kg	Nb. of PAX
A330 - A350	1.000	12
A321 - A320 - A319 - A220	500	6

If it is necessary to make changes after the off-block, they shall be handled in accordance with the following procedures:

1. If pushback operations are in progress, the Flight Deck shall be informed via interphone and a written note of the verbal communication between Load Control and Headset Operator shall be taken.
2. If pushback operations are completed, and prior to take off, Flight Deck shall be informed through Ground/Tower frequency and a written note of the verbal communication shall be taken.

Aforementioned events, defined as "discrepancies", shall always be communicated to a Company representative according to the foreseen procedures.

4.4 BALANCE CHART

4.4.1 GENERAL

Current versions of Company Balance Chart forms are distributed in all network stations.

The "Balance Chart" form allows the centre of gravity position to be determined with any weight, passenger distribution and deadload conditions on board the aircraft. It also allows to check that the centre of gravity falls within the safe range.

The data for the compilation of the form are obtained from the Loadsheet.

The instructions for compilation of the balance chart are given on the back of the form itself.

Note: In the case of need a limited quantity of forms is contained in the pouch for technical operations documentation on board the aircraft.

For some aircraft type a multiple operational weights called "Weight Variant" has been introduced. If any variation on aircraft operational weights will take place, relevant BC form will remain the same. Always check current version of "Mass & Balance Data Sheet" (MBDSH) for identifying the correct operational weight to be used and current BC form to choose accordingly to Aircraft registration as shown in figure below.

No.	Aircraft Type	Reg. Mark	Seats capacity	MTW	MTOW	MLW	MZFW	Balance Chart Form	B.C. Rev. Nr	B.C. Rev. Date	Loading Instructions Form	Load. Inst. Rev. Nr	Load. Inst. Rev. Date
1	A320-216	EI-DSE	148/165	68400	68000	64500	60500	MSS A320-216 148/165PSG MTOW/68,0 ton (4)	2	DEC-12	MSS - Loading Instructions A320 -A-	2	FEB 13
2	A320-216	EI-DSE	148/165	68400	68000	64500	60500	MSS A320-216 148/165PSG MTOW/68,0 ton (4)	2	DEC-12	MSS - Loading Instructions A320 -A-	2	FEB 13
3	A320-216	EI-DSE	148/165	68400	68000	64500	60500	MSS A320-216 148/165PSG MTOW/68,0 ton (4)	2	DEC-12	MSS - Loading Instructions A320 -A-	2	FEB 13
4	A320-216	EI-DSE	148/165	68400	68000	64500	60500	MSS A320-216 148/165PSG MTOW/68,0 ton (4)	2	DEC-12	MSS - Loading Instructions A320 -A-	2	FEB 13

4.4.2 FILLING

1. After filling in Loadsheet, identify operational weights (weight variant) to use on BC (see figure below)..

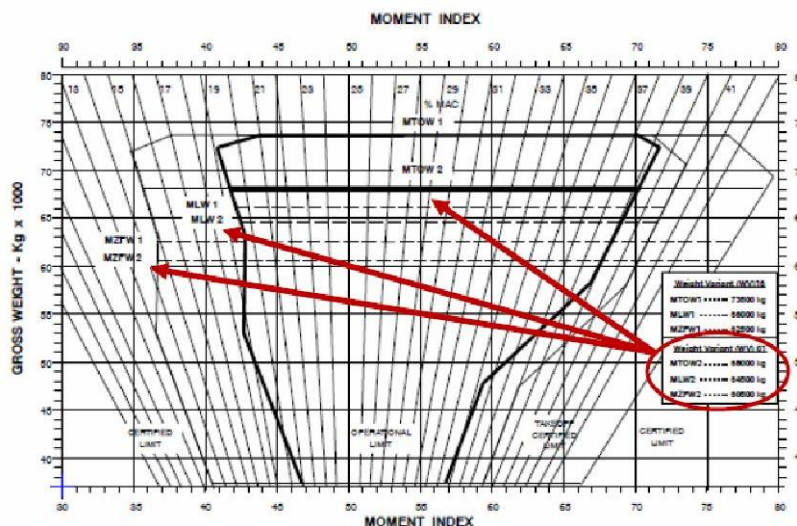

2. Mark the point corresponding to the BOI, parallel to the BOW, on the moment index scale.
3. Proceed vertically up to the first level of intersection corresponding.

 Volume II HLM	WEIGHT & BALANCE	4.4	Page 2
	BALANCE CHART	Ed 2/20 apr 2022	

4. Draw a horizontal line in the direction shown by the arrow, of the length corresponding to the weight of the compartment: each interval between two vertical lines (pitch) corresponds to the referred box, therefore, each interval between two points (dot) have to be divided for the dot included in the pitch: this will determinate the weight corresponding between two dots.
5. From the ending point of said horizontal line go down to the level below corresponding to comp. n. 2 and repeat the same operation, then go down to all the levels in turn following the same procedures. For passengers sections the same procedure used for cargo holds shall be followed, bear in mind that Pitch are based on the standard weight of 84 Kg for adult, therefore when the passenger weight is calculated differently (i.e. holiday charter, flights from/to Japan) the scale shall be calculated (i.e. holiday charter >> number of pax seated in the cabin zone x 76 Kg : 84 Kg = number of pax to consider; i.e. flights from/to Japan >> number of pax seated in the cabin area x 74 Kg : 84 Kg = number of pax to consider).f

Note: In certain load conditions, it may occur that the number of pitches shown in the moment index is insufficient.

In such cases, the use of indexes with a different sequence to that drawn on the balance chart design is advised. This strategy will not alter the final result.

5. From the last level descend vertically down to the point of intersection with the horizontal line corresponding to the ZFW: this point gives the C.G. in % of M.A.C.
6. The table at the back of the balance chart shows the variation of the moment index according to the quantity of fuel in the tanks. This variation in index must be marked on the diagram starting from the ZFW point: by intersecting the vertical line obtained with the horizontal line corresponding to the TOW, the C.G. in % of M.A.C. at TOW is determined.

Note: In the case of ferry, training or test flights, the C.G. may fall within the zone "Certified Limit", for the commercial flights with passenger on board, shall remain in the zone "Operational Limit".

7. Balance conditions relative to the TOW and the ZFW, expressed in MAC (mean aerodynamic chord) percentages, must be recorded in the "balance conditions" box of the Loadsheel. For Loadsheel processed by an automatic system (EDP):
 - the balance chart need not be compiled if the Loadsheel contains the "balance conditions" at TOW and ZFW expressed in MAC percentages
 - a partial compilation of the balance chart is required if the Loadsheel gives different "balance conditions" from those required
 - a complete compilation of the balance chart is required if the Loadsheel does not contain "balance conditions"

4.4.2.1 Balance Chart Example

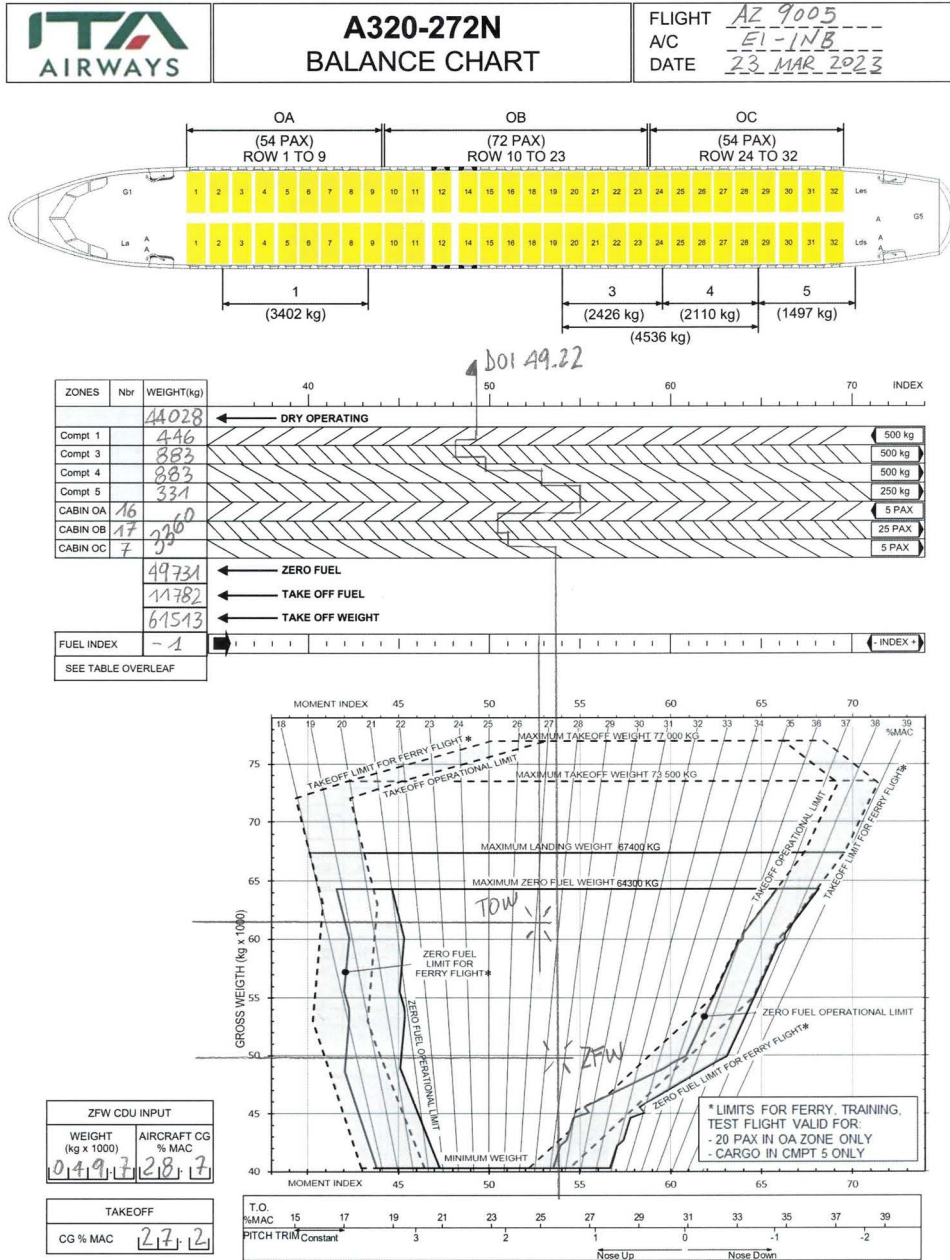

BALANCE CHART

USE OF BALANCECHART. For explanation of use of the Balance Chart, see FCOM PER-LOD-WBA-LTS. Refer to Crew Alert Notice or Mass and Balance Data Sheet to check for any updated values.

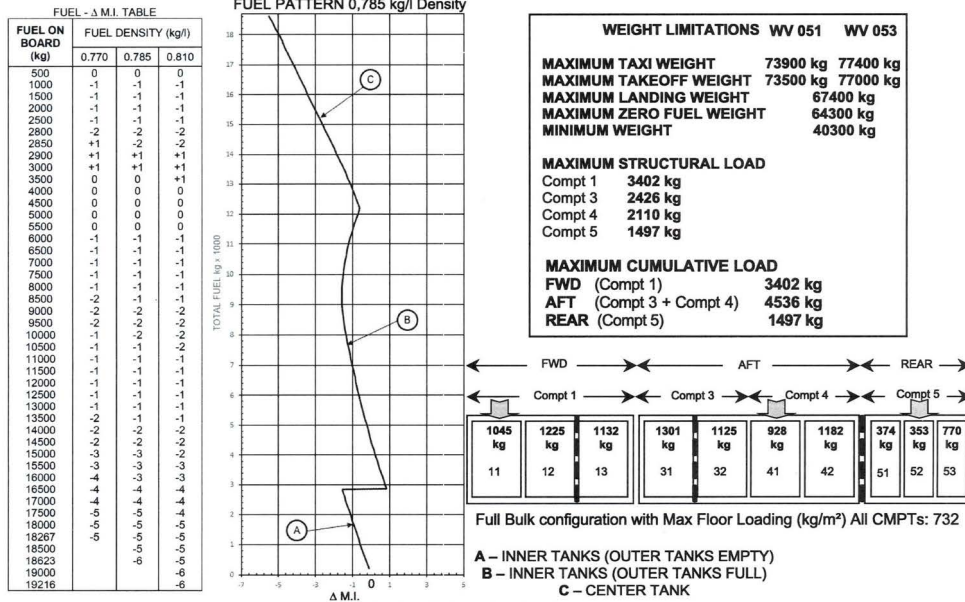

LOAD LIMITATION CHECK

- 1) According to the number of passenger, for each Passenger Cabin (**OB not involved because considered in analysis**) enter the Weight/Bending Index columns reporting the respective values.
- 2) For each Bay of Cargo Compartment, enter the table with the relevant weight and report the Weight and the corresponding Bending Index in the proper columns.
- 3) According to the **A/C ZFWCG**, compute the total values and compare the total Weight/Bending Index for both FWD and AFT LIMITS with the structural ones.
- 4) The structural limits must always be **EQUAL to or GREATER** than the total ones found in 3).

PASSENGER CABIN				PASSENGER CABIN				Cargo compartment - "BULK" loading (no CLS installed)					STRUCTURAL LIMITATIONS FWD				STRUCTURAL LIMITATIONS AFT					
Psg	WEIGHT (kg)	BENDING INDEX (B.I.)		Psg	WEIGHT (kg)	BENDING INDEX (B.I.)		WEIGHT (kg)	BENDING INDEX (B.I.)				ZFWCG (kg)	WEIGHT (kg)		BENDING INDEX (B.I.)		ZFWCG (kg)	WEIGHT (kg)		BENDING INDEX (B.I.)	
		FWD-OA	AFT-OC			CMPT 1	CMPT 3		CMPT 4	CMPT 5	WEIGHT	BENDING INDEX		WEIGHT	BENDING INDEX	WEIGHT	BENDING INDEX		WEIGHT	BENDING INDEX		
1	84	6	10	31	2604	139	261															
2	168	12	19	32	2688	142	268															
3	252	17	29	33	2772	144	274															
4	336	23	39	34	2856	147	281															
5	420	29	49	35	2940	150	287															
6	504	35	58	36	3024	152	294															
7	588	40	68	37	3108	154	300															
8	672	45	77	38	3192	157	306															
9	756	51	86	39	3276	159	312															
10	840	56	95	40	3360	161	318															
11	924	61	104	41	3444	163	324															
12	1008	66	113	42	3528	165	330															
13	1092	71	122	43	3612	166	336															
14	1176	75	130	44	3696	168	341															
15	1260	80	139	45	3780	169	347															
16	1344	84	147	46	3864	171	352															
17	1428	89	155	47	3948	172	358															
18	1512	93	164	48	4032	174	363															
19	1596	97	172	49	4116	175	368															
20	1680	101	180	50	4200	175	373															
21	1764	105	187	51	4284	176	377															
22	1848	109	195	52	4368	177	382															
23	1932	113	203	53	4452	178	387															
24	2016	117	211	54	4536	179	392															
25	2100	120	218																			
26	2184	123	225																			
27	2268	127	233																			
28	2352	130	240																			
29	2436	133	247																			
30	2520	136	254																			

 Volume II HLM	WEIGHT & BALANCE	4.5	Page 1
	FLIGHT DOCUMENTATION COLLECTION AND FILING	Ed 2 Rev 15/07 aug 25	

4.5 FLIGHT DOCUMENTATION COLLECTION AND FILING

The whole documentation for each flight must be archived, in original hard copy or electronically (even scanned), for a period described in the table below. It will be Ground staff responsibility to collect the signed copies listed in “document” column:

FILING PERIOD	DOCUMENT
6 MONTHS (*)	<ul style="list-style-type: none"> • Loading Instructions • Loadsheet (***) • Balance Chart (if manual) • The first 2 pages of the Operational Flight Plan (OFP) (****) • Summary Fuel Page (for JIT flights) • Walk-Around Checks Form • The ATL (ITA) and ACL (ITA) YELLOW pages (**) • Cargo Manifest • NOTOC (if applicable) • Messages (LDM and CPM in & out) • Fuel Order Document (****)

Note: Further documentation may be requested according to Company requirements or to local authority regulation.

(*) - The period starts from the date of document issue and may be longer than six months when, as per Company request, it is necessary or helpful for administrative or legal proceedings.

(**) - The ATL and ACL YELLOW pages can be filed for just 3 months.

(***) - ACARS Loadsheet, accepted by the Captain, is filed centrally in the Company server “Aircom Server”.

(****) - The departing flight Station (except for FCO) must deliver to the cockpit crew the first 2 pages of the OFP (OFP is part of the Briefing Package (BP)). The FCO station instead of the OFP pages uses the Fuel Order Document issued by DCS ALTEA FM. Before flight departure, ramp agent shall collect these pages of the OFP (Fuel Order Document for FCO) signed by Captain certifying the fuel quantity loaded on board.

Note: Any printing of the BP, to be delivered to Captain, must take place with a maximum advance of 100 minutes before the flight departure. This is applicable for all flights operated by Narrow Body aircraft only, in order to ensure the accuracy of the data.

INFORMATION PER AIRCRAFT TYPE

 ITA AIRWAYS Volume II HLM	INFORMATION PER AIRCRAFT TYPE	5.1	Page 1
	A-350 - ITA	Ed 2/20 apr 2022	

5.1 A-350 - ITA

5.1.1 HOLDS

5.1.1.1 Cargo compartment specifications

CARGO COMPARTMENT SPECIFICATIONS A-350	
MAX CARGO/BAGS CAPACITY	42500 Kg
MAX CARGO/BAGS VOLUME	171,5 m ³
FORWARD HOLD (compartments 1-2)	<ul style="list-style-type: none"> • Up to 6 PALLET 88" / 96" any INTERMIX • Up to 20 AKE CONTAINERS
AFT HOLD (compartments 3-4)	<ul style="list-style-type: none"> • Up to 5 PALLET 88" / 96" any INTERMIX • Up to 16 AKE CONTAINERS
BULK HOLD (compartment 5)	Kg 1500 - Volume 10,4 m ³ - BULK LOAD

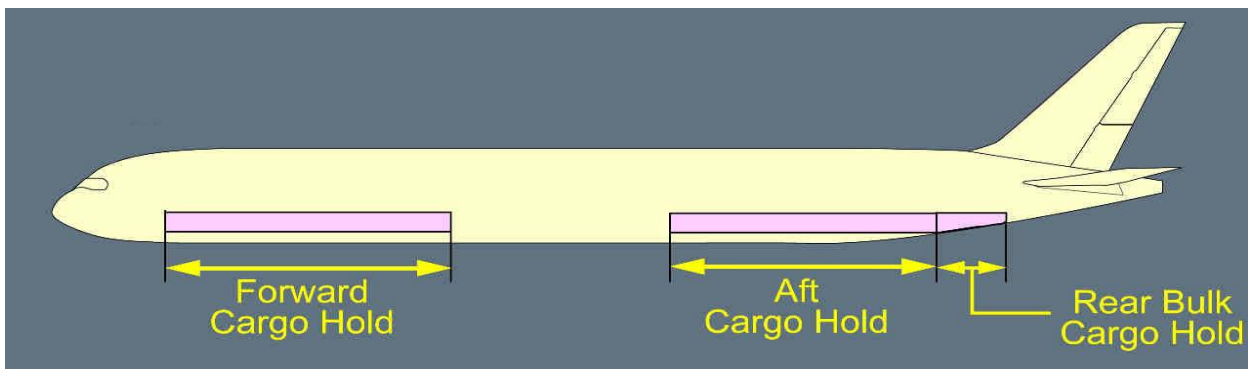

A350 aircraft is built with composite material so it needs special attention during ground handling. Ground staff, in case of impact with the aircraft while moving vehicles or equipment, shall always request engineering or captain assistance in order to evaluate correctly a possible damage. Further, for all equipment, except for the ones used for passenger assistance, it will be applied the "NO TOUCH POLICY".

 Volume II HLM	INFORMATION PER AIRCRAFT TYPE	5.1	Page 2
	A-350 - ITA	Ed 2/20 apr 2022	

Composite material - Nacelle structure



Following ULD positions in FORWARD COMPARTMENTS:

- **ULD base 88"x125"** (es. PAG, AAP, RAP)

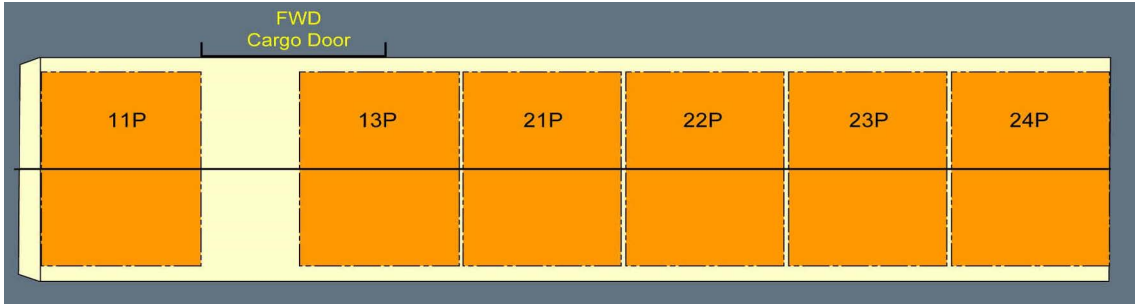

- **ULD base 96"x125"** (es. PMC, AMP)

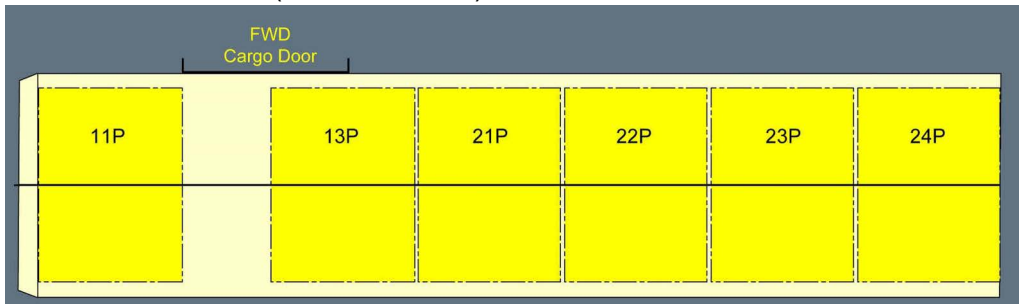

- **ULD base 60.4"x61.5"** (es. AKE)

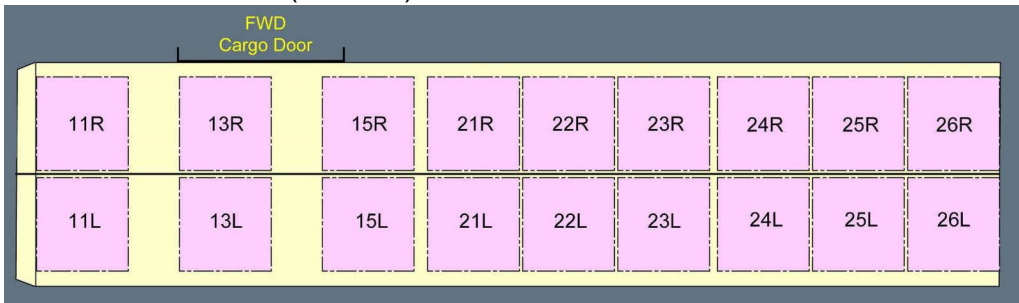

- **ULD base 60.4"x61.5"** (es. AKE)

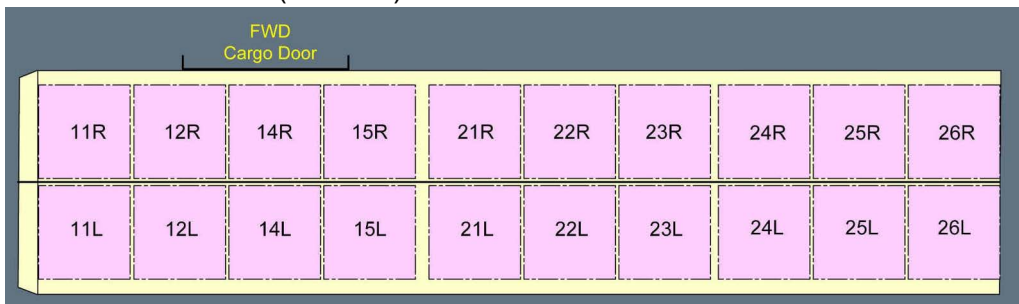

Pallet height must not exceed 162.5 cm (64 inches)

Following ULD positions in AFT COMPARTMENTS:

- **ULD base 88"x125"** (es. PAG, AAP, RAP)

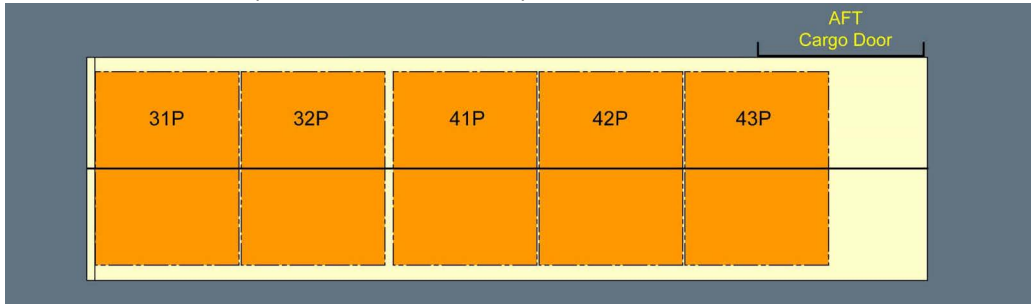

- **ULD base 96"x125"** (es. PMC, AMP)

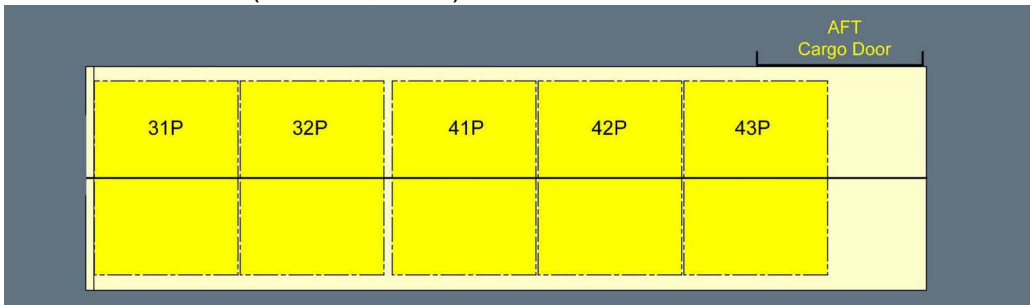

- **ULD base 60.4"x61.5"** (es. AKE)

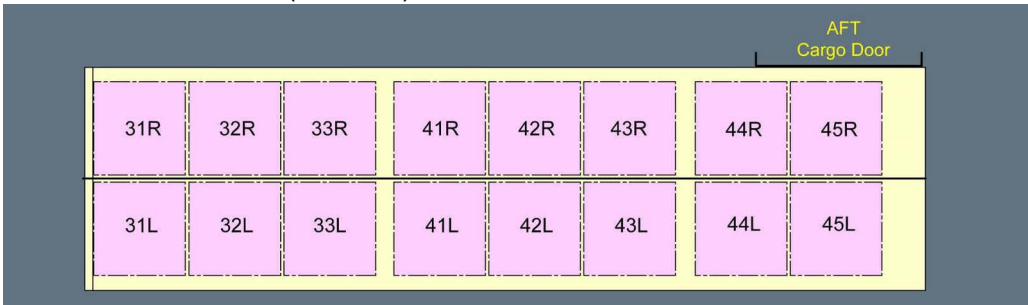

Pallet height must not exceed 162.5 cm (64 inches)

 Volume II HLM	INFORMATION PER AIRCRAFT TYPE	5.1	Page 5
	A-350 - ITA	Ed 2 Rev 17/27 jan 26	

Compartment 5 "Bulk" is reserved for bulk loads.

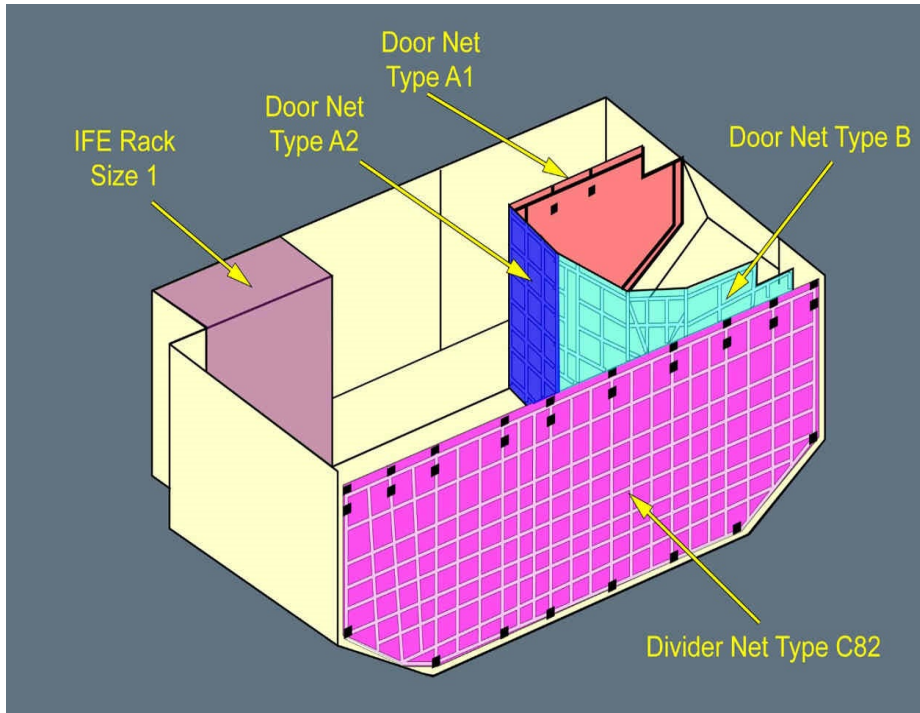

 Volume II HLM	INFORMATION PER AIRCRAFT TYPE	5.1	Page 6
	A-350 - ITA	Ed 2 Rev 9/14 jun 24	

Forward and aft loading compartment configurations are flexible as they allow a **miscellaneous of pallet/containers based 88"/96"x125"** (PAG, PMC, RAP, AAP, AMP) **and AKE containers, or PKC pallet** respecting the following conditions:

- Binding of ULD based 88"/96"x125" and AKE containers or PKC pallet is single type, that is, each position (i.e. 11P, 21R, 32P, 33L, etc.) has its own locks.



In case of a PMC (96"x125") in position 13P, due to cargo door dimension, it will not be possible to use positions 12L/12R 13L/13R.

Following table consider the constraint information above described and show the adopted loading configurations for the forward and aft compartments..

LOADING CONFIGURATION COMPARTMENTS 1 - 2 - 3 - 4																																
Reference Number																																
	COMPARTMENTS 3 - 4																															
	ULD base 88"/96"x125"						AKE/PKC										ULD base 88"/96"x125"					AKE/PKC										
	11P	13P	21P	22P	23P	24P	11 L/R	12 L/R	13 L/R	14 L/R	15 L/R	21 L/R	22 L/R	23 L/R	24 L/R	25 L/R	26 L/R	31P	32P	41P	42P	43P	31 L/R	32 L/R	33 L/R	41 L/R	42 L/R	43 L/R	44 L/R	45 L/R		
000 A							X	X		X	X	X	X	X	X	X	X							X	X	X	X	X	X	X		
010 A	X									X	X	X	X	X	X	X	X							X	X	X	X	X	X	X	X	
011 A		X					X	X				X	X	X	X	X	X							X	X	X	X	X	X	X	X	
012 A						X	X	X			X	X	X	X	X									X	X	X	X	X	X	X	X	
013 A							X	X		X	X	X	X	X	X	X	X	X								X	X	X	X	X	X	
014 A							X	X		X	X	X	X	X	X	X	X					X		X	X	X	X	X	X			
020 A	X	X										X	X	X	X	X	X							X	X	X	X	X	X	X	X	
020 B	X	X							X			X	X	X	X	X	X							X	X	X	X	X	X	X	X	
021 A					X	X	X	X		X	X	X	X	X										X	X	X	X	X	X	X	X	
022 A					X	X	X	X		X	X	X	X	X			X									X	X	X	X	X	X	
023 A							X	X		X	X	X	X	X	X	X	X	X	X								X	X	X	X	X	
024 A							X	X		X	X	X	X	X	X	X	X			X	X			X	X	X				X	X	
030 A				X	X	X	X	X		X	X	X												X	X	X	X	X	X	X	X	
031 A				X	X	X	X	X		X	X	X	X	X			X									X	X	X	X	X	X	
032 A				X	X	X	X	X		X	X	X	X	X			X	X										X	X	X	X	X
033 A	X									X	X	X	X	X	X	X	X	X	X								X	X	X	X	X	

LOADING CONFIGURATION COMPARTMENTS 1 - 2 - 3 - 4																													
Reference Number																													
	COMPARTMENTS 3 - 4																												
	ULD base 88"/96"x125"						AKE/PKC										ULD base 88"/96"x125"					AKE/PKC							
	11P	13P	21P	22P	23P	24P	11 LR	12 LR	13 LR	14 LR	15 LR	21 LR	22 LR	23 LR	24 LR	25 LR	26 LR	31P	32P	41P	42P	43P	31 LR	32 LR	33 LR	41 LR	42 LR	43 LR	44 LR
034 A	x	x									x	x	x	x	x	x	x												
034 B	x	x					x			x	x	x	x	x	x	x	x							x	x	x	x	x	x
035 A							x		x	x	x	x	x	x	x	x		x	x	x		x						x	x
040 A			x	x	x	x	x	x		x												x	x	x	x	x	x	x	x
041 A				x	x	x	x	x		x	x						x							x	x	x	x	x	x
042 A					x	x	x	x		x	x	x	x				x	x						x	x	x	x	x	x
043 A	x	x									x	x	x	x	x	x	x	x						x	x	x	x	x	x
043 B	x	x									x	x	x	x	x	x	x	x						x	x	x	x	x	x
044 A							x	x		x	x	x	x	x	x	x		x	x	x	x	x							
050 A		x	x	x	x	x	x	x	x														x	x	x	x	x	x	x
051 A	x		x	x	x	x				x	x												x	x	x	x	x	x	x
052 A			x	x	x	x	x	x		x	x						x							x	x	x	x	x	x
053 A				x	x	x	x	x		x	x	x					x	x						x	x	x	x	x	x
054 A	x	x	x	x											x	x	x							x	x	x	x	x	x
054 B	x	x	x	x				x							x	x	x	x						x	x	x	x	x	x
055 A	x	x									x	x	x	x	x	x	x	x	x								x	x	x
055 B	x	x						x			x	x	x	x	x	x	x	x	x								x	x	x
056 A					x	x	x	x		x	x	x	x	x					x	x	x	x	x	x					

LOADING CONFIGURATION COMPARTMENTS 1 - 2 - 3 - 4																														
Reference Number	COMPARTMENTS 3 - 4																													
	ULD base 88"/96"x125"						AKE/PKC										ULD base 88"/96"x125"					AKE/PKC								
	11P	13P	21P	22P	23P	24P	11LR	12LR	13LR	14LR	15LR	21LR	22LR	23LR	24LR	25LR	26LR	31P	32P	41P	42P	43P	31LR	32LR	33LR	41LR	42LR	43LR	44LR	45LR
	060 A	x	x	x	x	x	x																	x	x	x	x	x	x	x
060 B	x	x	x	x	x	x				x													x	x	x	x	x	x	x	
061 A	x		x	x	x	x				x	x						x							x	x	x	x	x	x	
062 A			x	x	x	x	x	x		x	x						x	x							x	x	x	x	x	
063 A				x	x	x	x	x		x	x	x					x	x	x								x	x	x	
064 A			x	x	x	x	x	x		x	x								x	x			x	x	x				x	x
070 A	x	x	x	x	x	x											x								x	x	x	x	x	
070 B	x	x	x	x	x	x				x							x								x	x	x	x	x	
071 A			x	x	x	x	x	x		x	x						x	x	x									x	x	x
072 A					x	x	x	x		x	x	x	x				x	x	x	x	x									
080 A	x	x	x	x	x	x											x	x							x	x	x	x	x	
080 B	x	x	x	x	x	x				x							x	x							x	x	x	x	x	
081 A	x		x	x	x	x					x	x					x	x	x								x	x	x	
082 A	x		x	x	x	x					x	x							x	x	x	x	x	x						
090 A	x	x	x	x	x	x											x	x	x								x	x	x	
090 B	x	x	x	x	x	x				x							x	x	x								x	x	x	
091 A	x	x	x	x	x	x													x	x	x	x	x	x						
091 B	x	x	x	x	x	x				x									x	x	x	x	x	x						

LOADING CONFIGURATION COMPARTMENTS 1 - 2 - 3 - 4																													
Reference Number																													
	COMPARTMENTS 3 - 4																												
	ULD base 88"/96"x125"						AKE/PKC										ULD base 88"/96"x125"					AKE/PKC							
	11P	13P	21P	22P	23P	24P	11 L/R	12 L/R	13 L/R	14 L/R	15 L/R	21 L/R	22 L/R	23 L/R	24 L/R	25 L/R	26 L/R	31P	32P	41P	42P	43P	31 L/R	32 L/R	33 L/R	41 L/R	42 L/R	43 L/R	44 L/R
092 A	x		x	x	x	x				x	x						x	x	x	x								x	x
100 A	x	x	x	x	x	x											x	x	x	x								x	x
100 B	x	x	x	x	x	x			x								x	x	x	x								x	x
101 A	x		x	x	x	x				x	x						x	x	x	x	x								
110 A	x	x	x	x	x	x											x	x	x	x	x								
110 B	x	x	x	x	x	x				x							x	x	x	x	x								

- X - 1 ULD base 88"x125" oppure 96"x125"
- X - 2 AKE/PKC
- X - 1 ULD base 88"x125"

 ITA AIRWAYS Volume II HLM	INFORMATION PER AIRCRAFT TYPE	5.1	Page 11
	A-350 - ITA	Ed 2 Rev 17/27 jan 26	



Due to fire extinguishing system feature, shipments containing Dangerous Goods (DG) as flammable and combustibles (class 2.1, 3 and 4) shall be loaded necessarily in the compartments 3 and 4. Segregation criteria shall be always respected (i.e. in case of DG class 2.1, 3 and 4, lithium-ion, lithium metal and sodium-ion batteries shall be loaded exclusively in the compartments 1-2).

COMPARTMENT	SURFACE RESISTANCE (Kg/m ²)	LINEAR RESISTANCE (Kg/m)	USABLE VOLUME (m ³)	MAX STRUCTURAL LOAD (Kg)
1	659	2.093	35,8	22000
2			53,7	
3			26,8	19000
4			44,8	
51	415		10,4	1500

Cargo holds are pressurized and have the following systems installed:

- smoke detection system,
- fire extinguishing system,
- ventilation system (compartments 1 - 2 - 5)..

MAXIMUM ULD LOAD PER POSITION (Kg)		
ULD base dimensions (inches)		
88 x 125 (PAG-AAP-RAP)	96 x 125 (PMC-AMP)	60.4 x 61.5 (AKE-PKC)
4.626	5.103	1.588

 Volume II HLM	INFORMATION PER AIRCRAFT TYPE	5.1	Page 12
	A-350 - ITA	Ed 2/20 apr 2022	

5.1.1.2 Cargo compartment temperature and ventilation

The following table shows all necessary information for the transportation of goods that need specific temperature and ventilation on board this kind of aircraft..

HOLD	TEMPERATURE RANGE	VENTILATION	GROUND CONTROL	COCKPIT CONTROL
1 - 2	5°C - 25°C	SI	NO	SI
3 - 4		SI	NO	SI
5	5°C - 25°C	SI	NO	SI

Nota: Damaged or missing separation net or cover will restrict the performance of compartment 5 ventilation system

5.1.1.3 Resistance of fittings

All compartments can host single tie-down fittings for the restraint of bulk loads.

The following table shows the fittings minimum resistance in every direction..

COMPARTMENT	MINIMUM RESISTANCE
1 - 2 - 3 - 4 - 5	5000 LB / 2267 Kg

The resistance can be calculated by multiplying the fittings resistance by the coefficient related to the angle.

DIRECTION	COMPARTMENT	RESTRAINT FACTOR
FORWARD	ALL	1,5 G
BACKWARD	ALL	0,8 G
RIGHT - LEFT	1 - 2	0,89 G
	3 - 4	1,28 G
	5	1,55 G
UPWARD	1 - 2	1,5 G
	3 - 4	1,88 G
	5	2,24 G

5.1.1.4 Forward hold (compartment 1-2) cargo door maximum dimensions

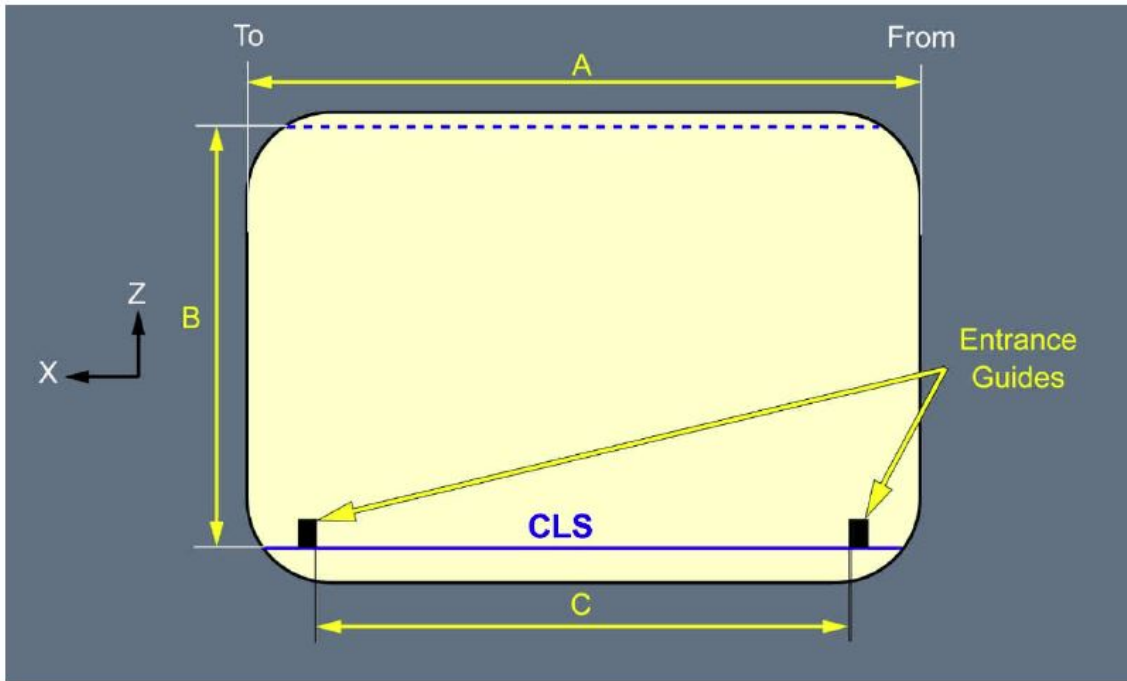

Legend		Dimensions	
		(m)	(in)
A	Clear opening width	2.852	112.28
B	Clear opening height	1.679	66.10
C	Door width at CLS level	2.533	99.72

5.1.1.5 Aft hold (compartment 3-4) cargo door maximum dimensions

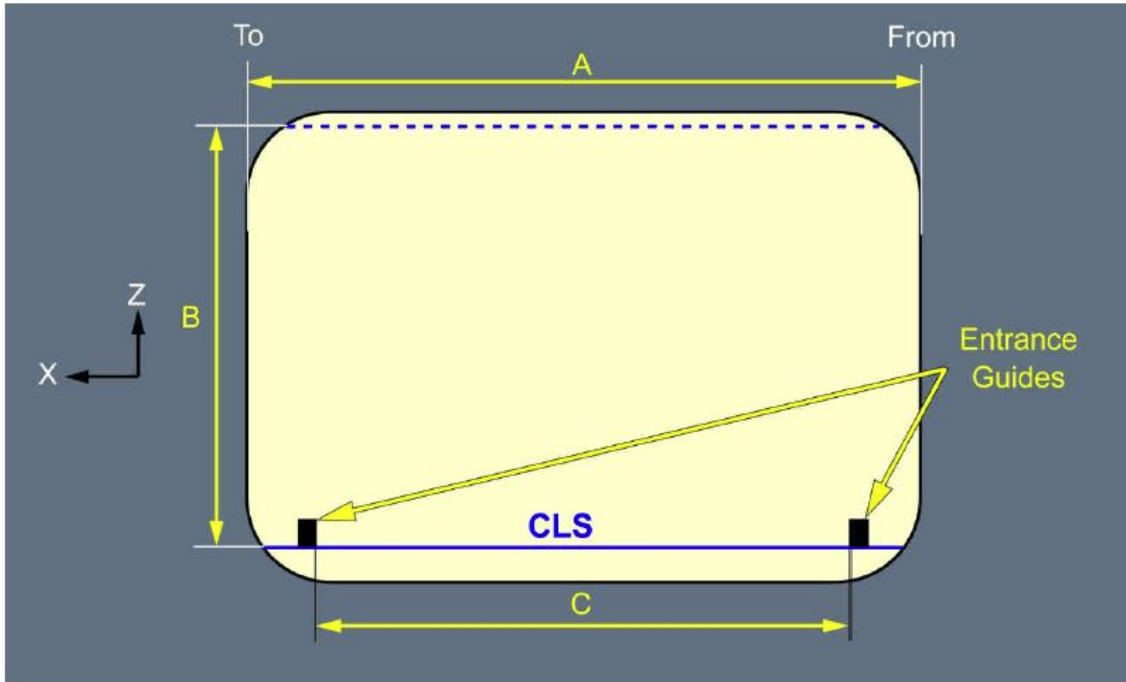

Legend		Dimensions	
		(m)	(in)
A	Clear opening width	2.797	110.12
B	Clear opening height	1.679	66.10
C	Door width at CLS level	2.490	98.03

5.1.1.6 Bulk hold (compartment 5) cargo door maximum dimensions

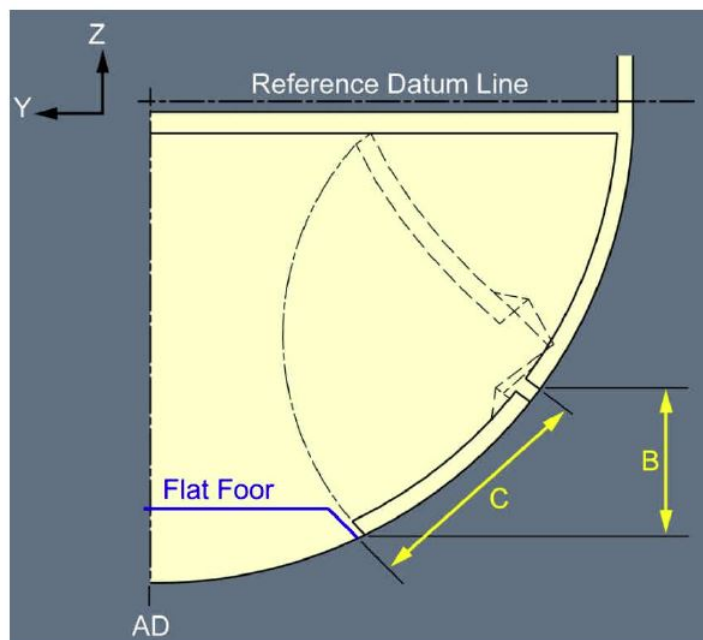
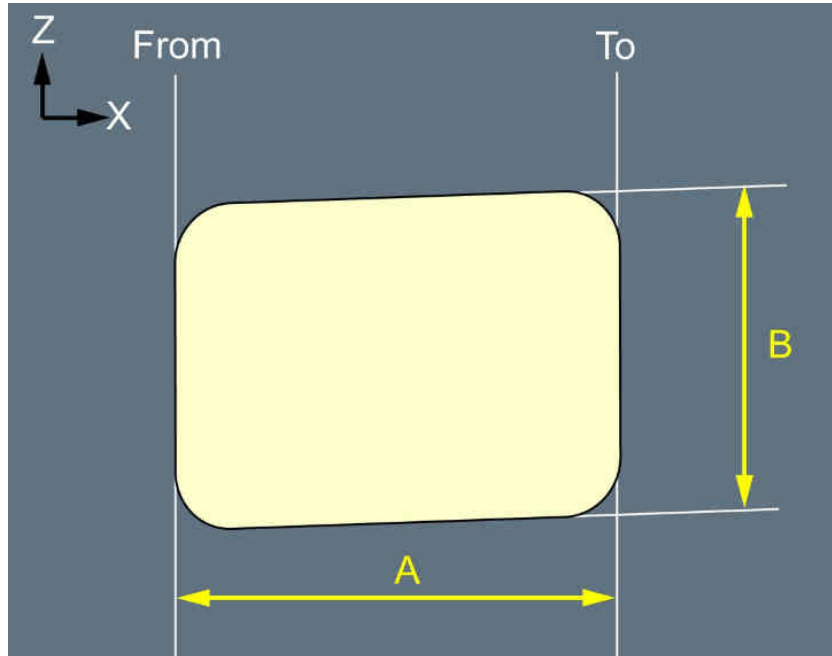

Legend		Dimensions	
		(m)	(in)
A	Clear opening width	0.950	37.40
B	Clear opening height (Vertical)	0.762	30.00
C	Clear opening height in plan view	1.230	48.42

 ITA AIRWAYS Volume II HLM	INFORMATION PER AIRCRAFT TYPE	5.1	Page 16
	A-350 - ITA	Ed 2/20 apr 2022	

5.1.1.7 Divider net between compartment 4 and 5

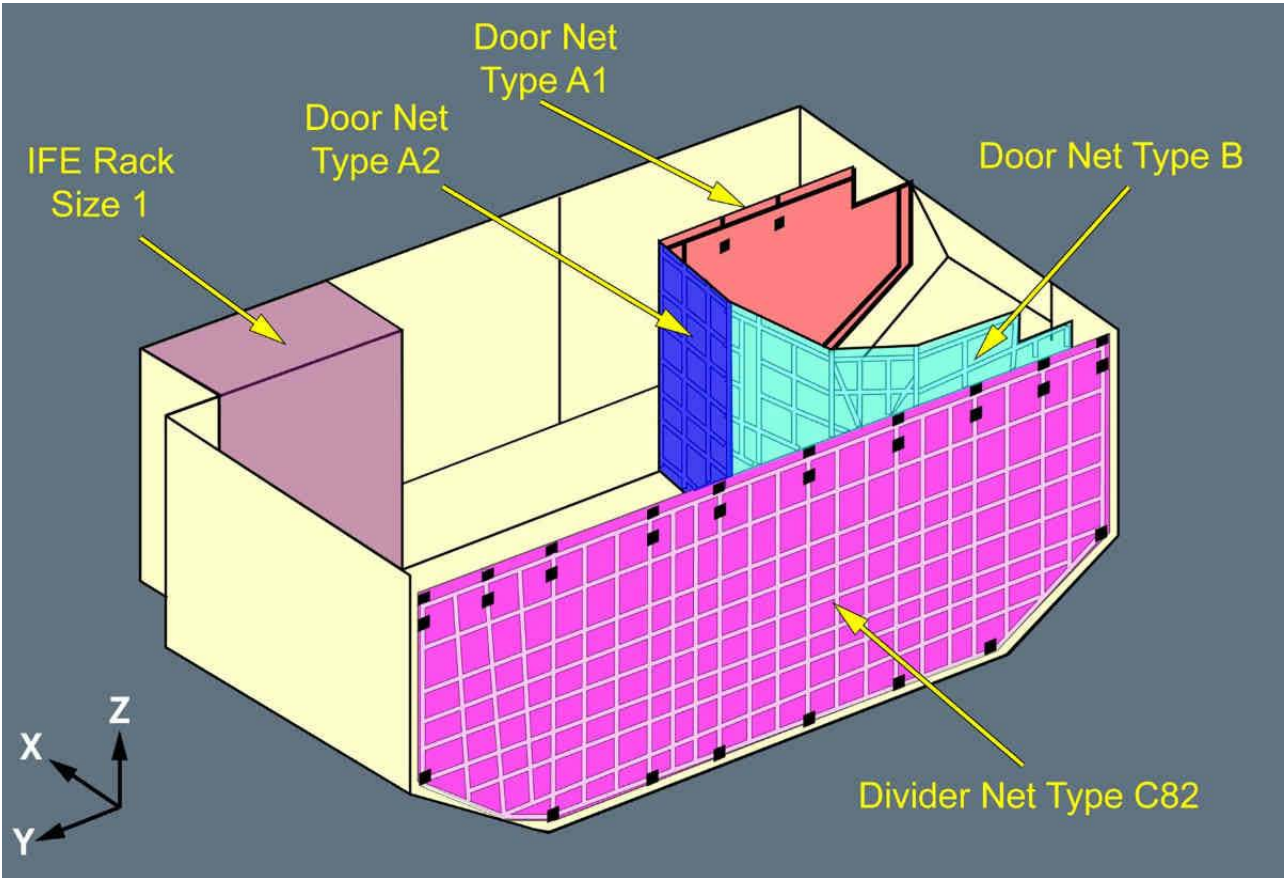

 Volume II HLM	INFORMATION PER AIRCRAFT TYPE	5.1	Page 17
	A-350 - ITA	Ed 2/20 apr 2022	

5.1.1.8 Maximum dimensions for conventional load in compartment 5

Maximum dimensions for cargo packages which will pass through the bulk door (compartment 5) are shown in the following paragraphs:

- par. 5.1.1.8.1 - for upright loading.
- par. 5.1.1.8.2 - for upright and tilted loading,
- par. 5.1.1.8.3 - for crosswise loading.

These dimensions are approximate values and refer to rectangular packages..

5.1.1.8.1 Upright loading

Upright loading applies to heavy packages, which only can be loaded with the assistance of mechanical ground support equipment and in a position parallel to the bulk compartment floor.

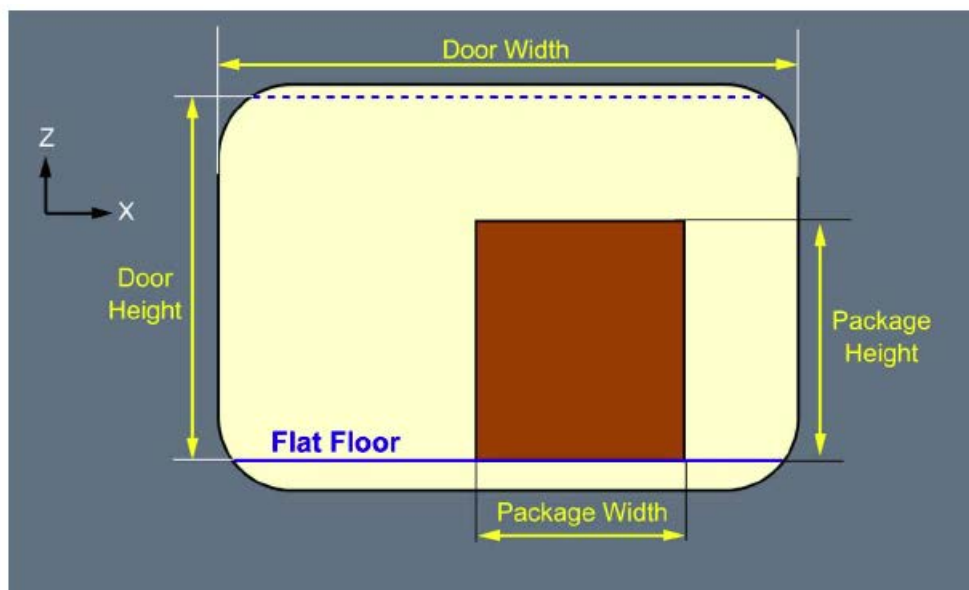

MAX Package Width		MAX Package Height		MAX Package Length		Package Positioning
(m)	(in)	(m)	(in)	(m)	(in)	
0.851	33.50	0.700	27.50	1.650	67.00	Figure 1
0.851	33.50	0.700	27.50	1.550	61.00	Figure 2
0.330	13.00	0.700	27.50	2.400	94.50	Figure 3

Figure 1: Upright Loading: Package lengthwise on flat floor

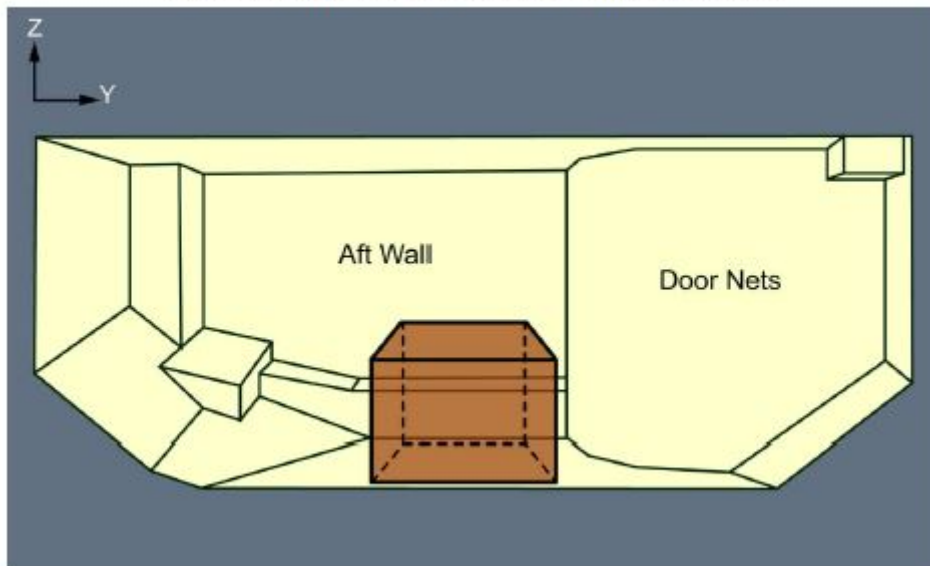
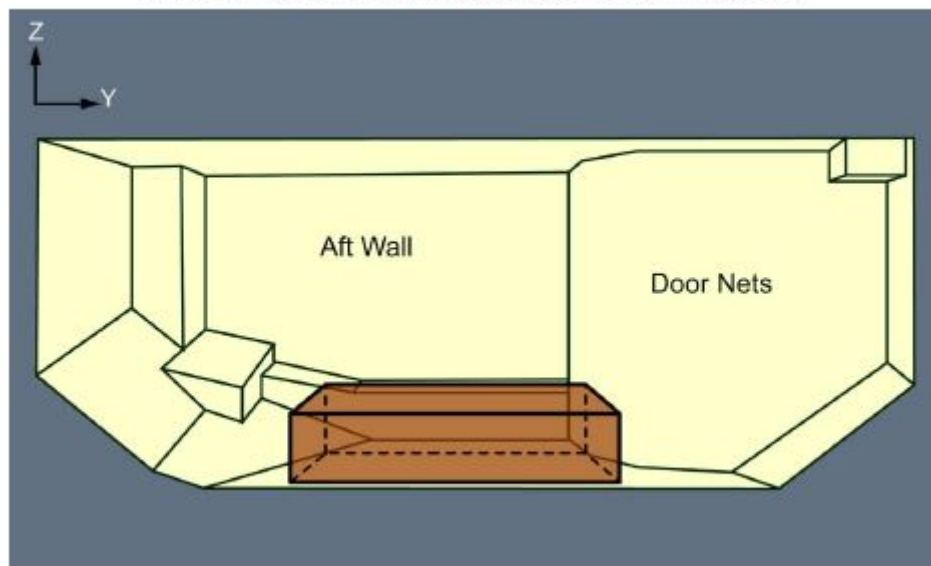

Figure 2: Upright Loading: Small package crosswise on flat floor





 Volume II HLM	INFORMATION PER AIRCRAFT TYPE	5.1	Page 19
	A-350 - ITA	Ed 2/20 apr 2022	

Figure 3: Upright Loading: Long package crosswise on flat floor

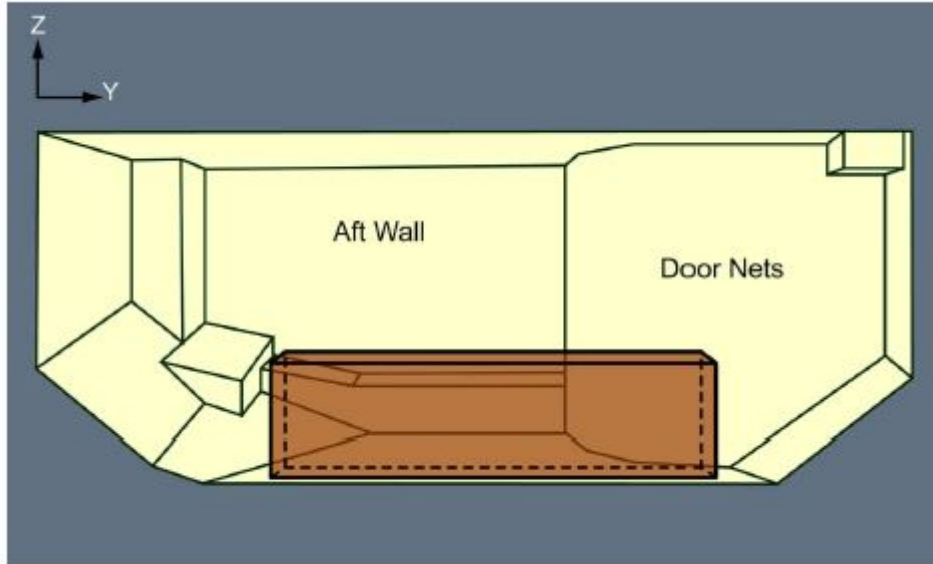

 ITA AIRWAYS Volume II HLM	INFORMATION PER AIRCRAFT TYPE	5.1	Page 20
	A-350 - ITA	Ed 2/20 apr 2022	

5.1.1.8.2 Upright and tilted loading

Upright loading and tilted loading applies to low density packages (weighing less than 150 Kg), which can be manoeuvred by hand. For loading the packages with maximum dimensions shown in table 2 it is not necessary to tilt the packages, but they must be lifted on the sloping part of the floor (provided that the package does not have a rigid structure).

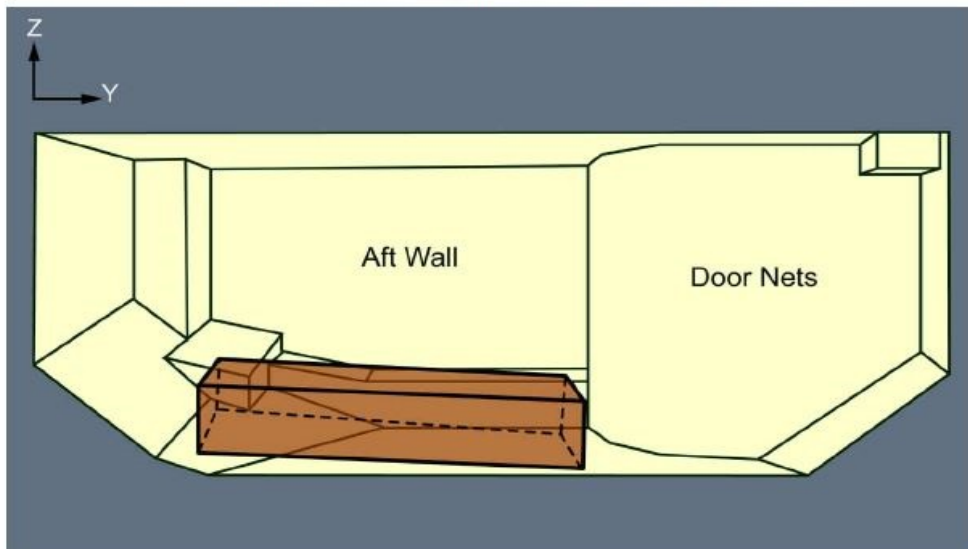
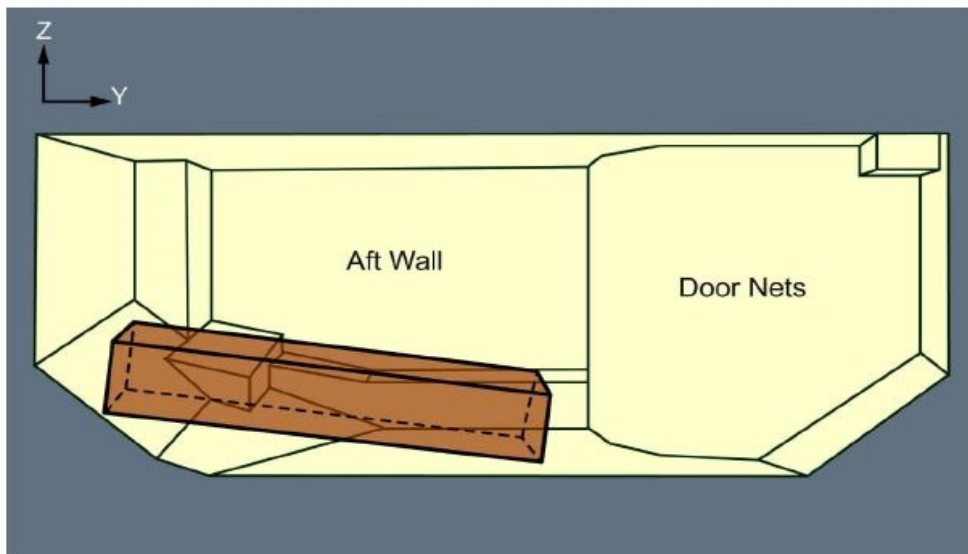

Considering weight and volume, it is mandatory the usage of load spreaders for tilted loading, that shall be positioned under the sections which are in contact with the hold floor.

5.1.1.8.3 Crosswise loading

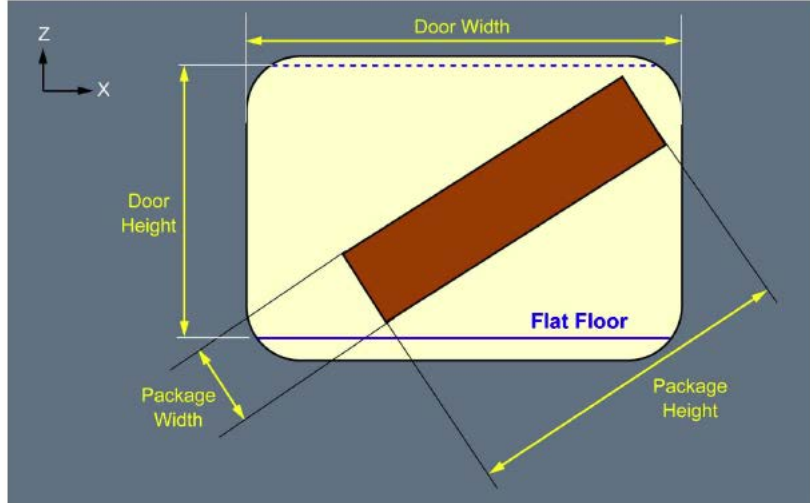

Package Width		Package Height		Package Length		Package Positioning
(m)	(in)	(m)	(in)	(m)	(in)	
0.330	13.00	1.100	43.00	2.400	94.50	Figure 4
0.850	33.50	1.000	39.30	2.300	90.50	Figure 5
1.200	47.20	0.200	7.90	2.400	94.50	Figure 6
0.950	37.40	0.500	19.70	2.200	86.60	Figure 6
1.200	47.20	0.500	19.70	2.000	78.70	Figure 7

Figure 4: Tilted Loading: Long package crosswise on flat floor

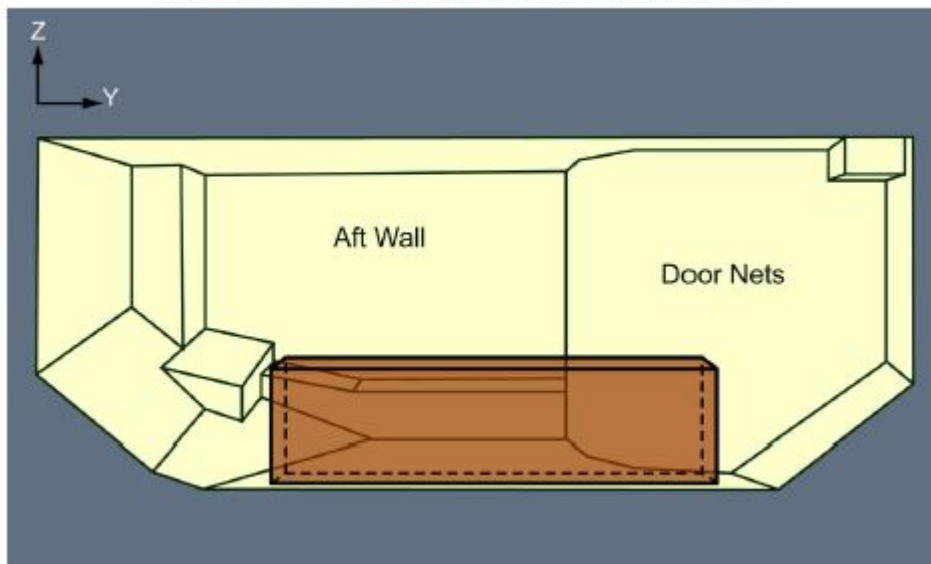

Figure 5: Tilted loading: Package lengthwise partly on rear step

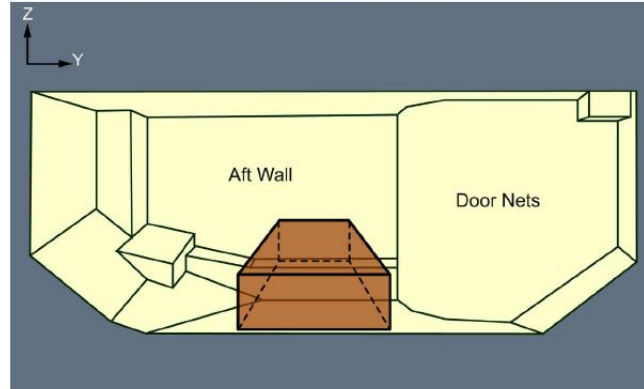

Figure 6: Tilted loading: Package crosswise partly on sloped floor

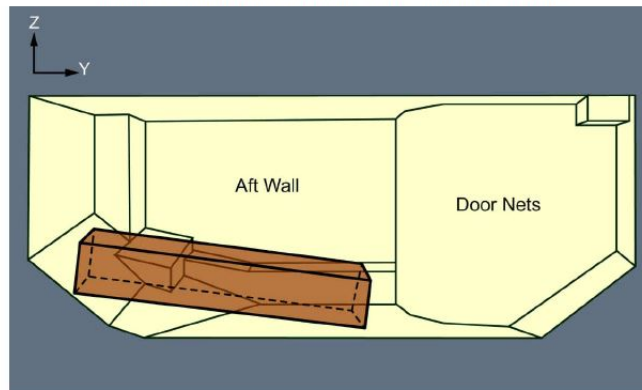
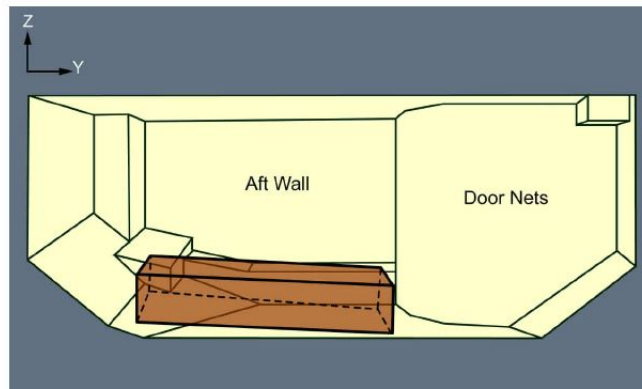

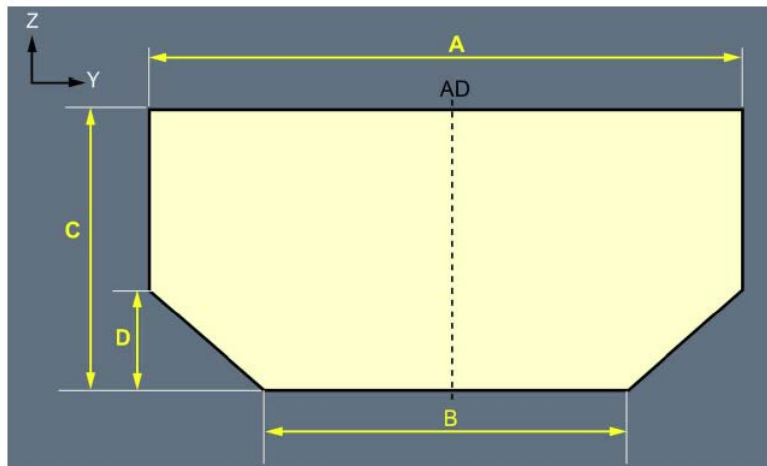

Figure 7: Tilted loading: Package crosswise partly on sloped floor



 Volume II HLM	INFORMATION PER AIRCRAFT TYPE	5.1	Page 23
	A-350 - ITA	Ed 2/20 apr 2022	

5.1.1.9 Cross section of compartments 1-2-3-4 - internal dimensions for the loading of conventional loads



Legenda	Dimensioni	
	(m)	(in)
A	4.064	160.00
B	3.175	125.00
C	1.626	64.00
D	0.498	19.60

Note:

- those given are the maximum dimensions: pallets must be built up in such a way as to keep the 5 cm / 2" minimum clearance from ceiling lights, smoke detectors and compartment contour,
- the pallet is about 2,5 cm (1") thick, and should be subtracted from the available height.

Overhangs on short sides of pallet based 88"/96"x125" are allowed

Overhangs on long side (125") of pallet based 88"x125" are allowed up to 8" (20 cm) provided that the overhang is not positioned next front / rear bulkheads and that a related obliged clearance is built in the adjoining pallet, if necessary

Overhangs on long side (125") of pallet based 96"x125" are not allowed

 ITA AIRWAYS Volume II HLM	INFORMATION PER AIRCRAFT TYPE		5.1	Page 24
	A-350 - ITA		Ed 2/20 apr 2022	

5.1.2 FUEL

Fuel is contained in three tanks, two in each cantilever wing box and one in the wing box center section.

Layout and identification of these tanks are shown in the illustration below.

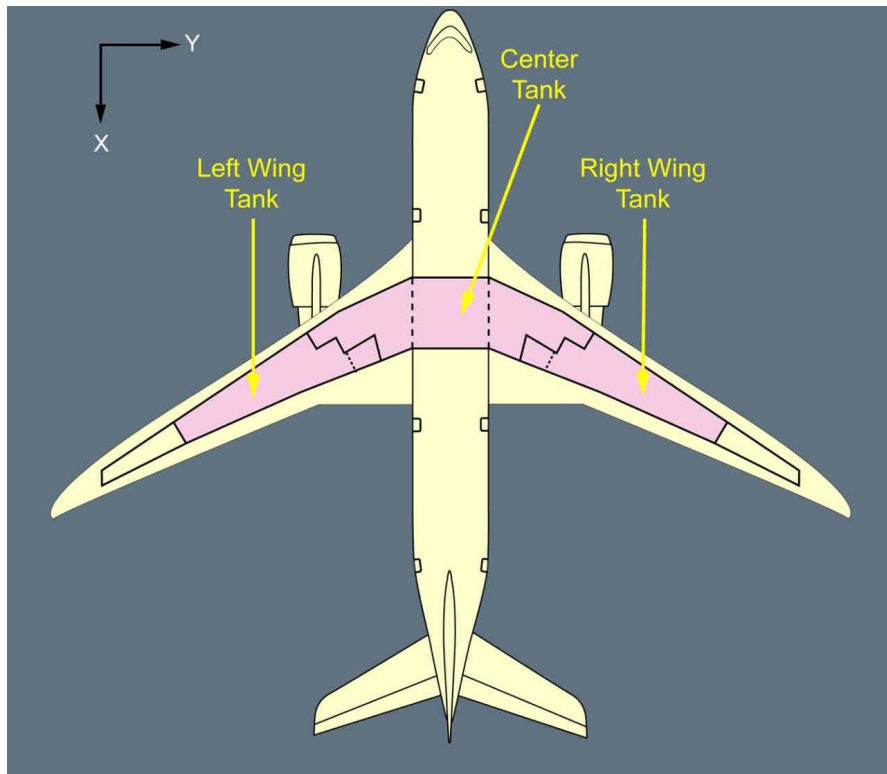

	A350-900 FUEL TANKS CAPACITY			
	Left Wing Tank	Right Wing Tank	Center Tank	TOTAL
CAPACITY (Lt.)	29900	29900	80900	140700
WEIGHT (Kg)	23400	23400	63500	110400

 ITA AIRWAYS Volume II HLM	INFORMATION PER AIRCRAFT TYPE	5.1	Page 25
	A-350 - ITA	Ed 2/20 apr 2022	

5.1.3 USE OF MARKER CONES

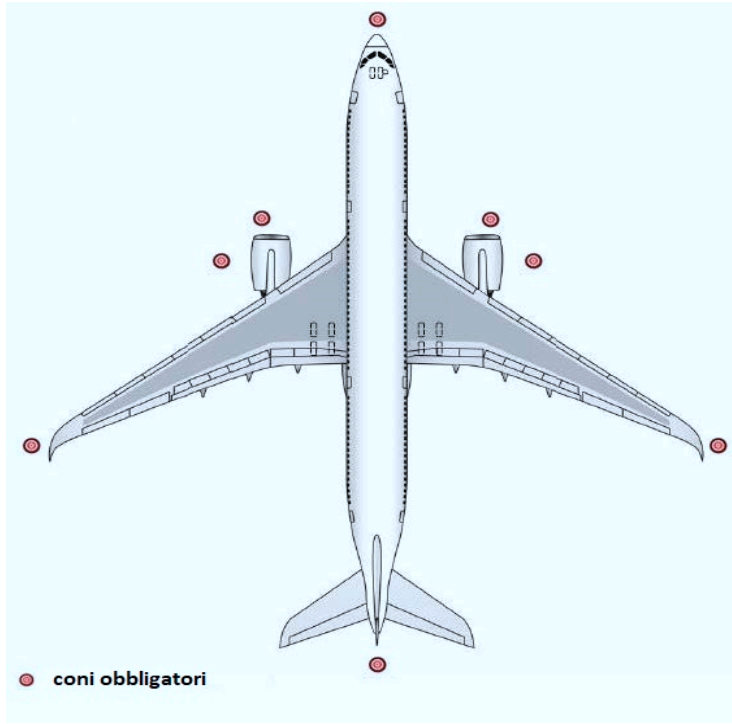

5.1.4 CHOCKING OF AIRCRAFT

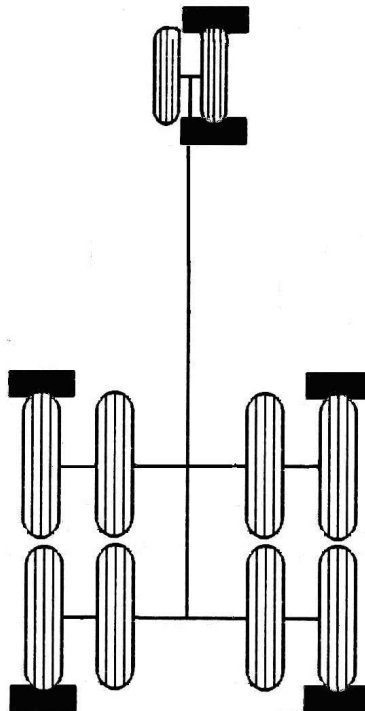

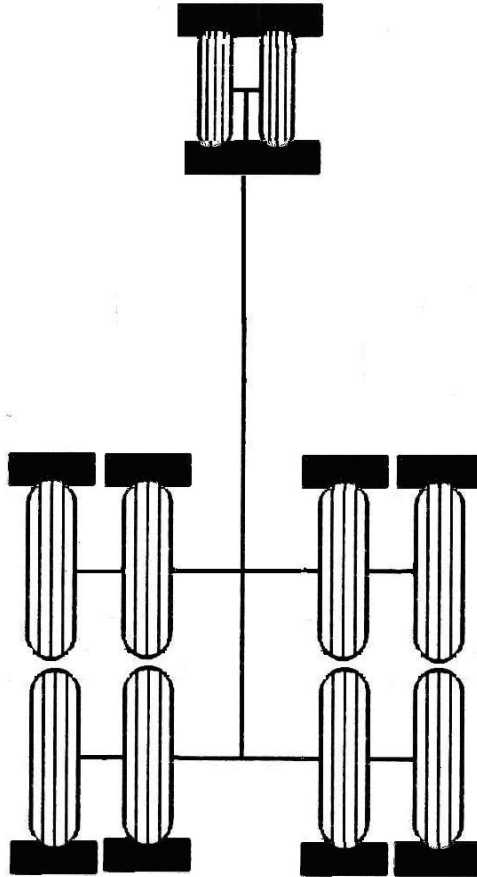

 Volume II HLM	INFORMATION PER AIRCRAFT TYPE	5.1	Page 26
	A-350 - ITA	Ed 2/20 apr 2022	

5.1.5 CHOCKING OF AIRCRAFT WITH WIND OVER 25 kt (46.3 km/h)

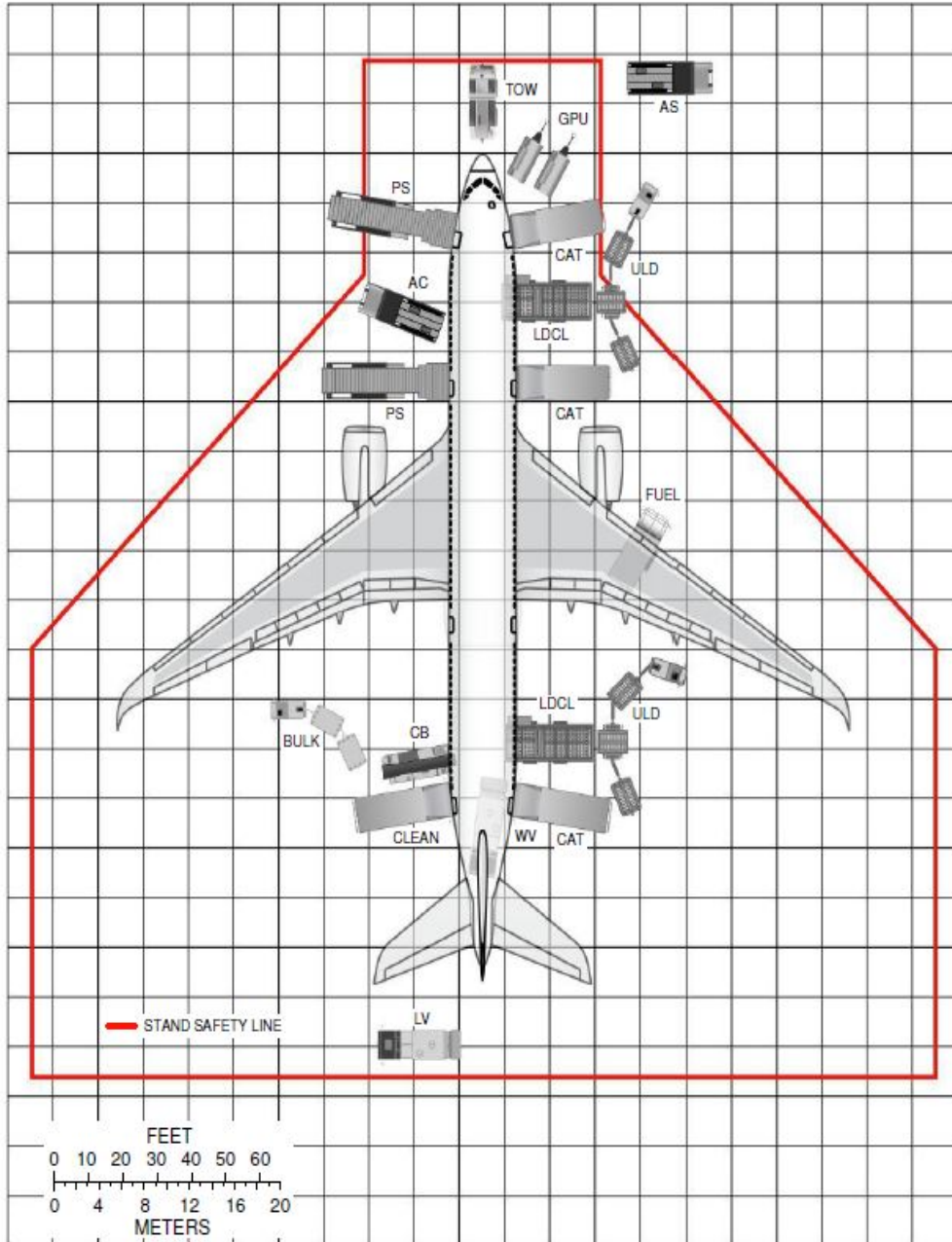

5.1.6 SERVICING ARRANGEMENTS



 Volume II HLM	INFORMATION PER AIRCRAFT TYPE	5.1	Page 28
	A-350 - ITA	Ed 2/20 apr 2022	

5.1.7 TOILETTE DRAIN

Below, the description of operational procedures for draining, flushing and filling of the chemical precharge.

1. Open service panel access door.
2. Unlock drain right valve using unlock lever.
3. Connect the waste drain hose coupling to panel drain nipple and assure that the hose is well connected.
4. Turn the left drain handle to unlock and pull until is fully extended.
5. While the tanks drain, feel the drain hose and make sure that all waste is draining out.

Note: If the draining is not performed correctly, inform a Company representative.

6. Turn the right drain handle to unlock and pull until is fully extended.
7. While the tanks drain, feel the drain hose and make sure that all waste is draining out.

Note: If the draining is not performed correctly, inform a Company representative.

8. Connect water supply hose coupling to the left flush nipple.
9. Flush the tank using 15 litres of chemical precharge, the pressure must not exceed 35 PSI.
10. Repeat the operation with the right flush nipple.
11. Close both drain handles valve.
12. Remove the waste drain hose coupling to panel drain nipple and leave the fitting cap opened.
13. Fill 18 litres of disinfectant precharge solution in the right tank, repeat the operation for the left tank.

Note: In case of leakage of chemical precharge from drain valves, inform a Company representative.

14. Closed the valves drain cap and latch the service panel.

 ITA AIRWAYS Volume II HLM	INFORMATION PER AIRCRAFT TYPE	5.1	Page 29
	A-350 - ITA	Ed 2/20 apr 2022	

5.1.7.1 Toilette drain servicing panel

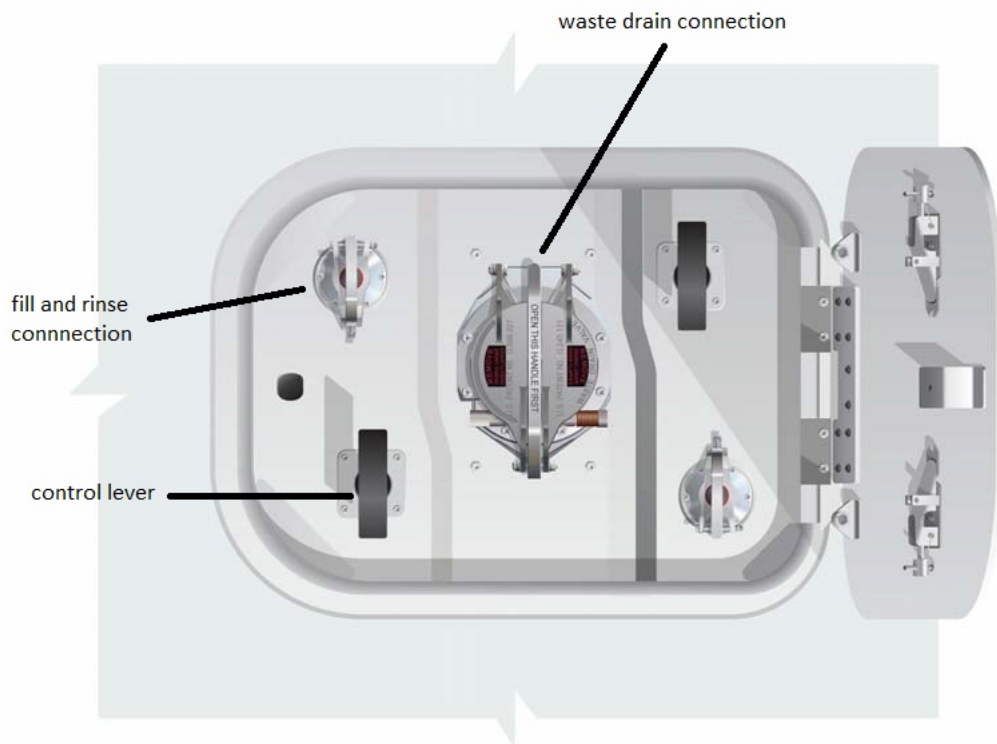
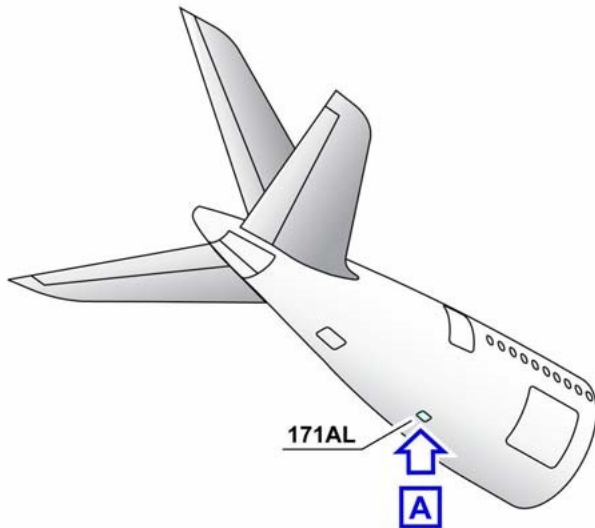

 Volume II HLM	INFORMATION PER AIRCRAFT TYPE	5.1	Page 30
	A-350 - ITA	Ed 2/20 apr 2022	

5.1.8 FILLING POTABLE WATER

Potable water service shall always be performed in automatic mode (electrically powered aircraft). If for technical reasons is not possible to operate in automatic mode use manual mode. Adopting this procedure the tanks will be filled to FULL; in this case is mandatory to inform the Flight Deck that the water quantity is up to full.

Below, the description of operational procedures for filling potable water.

AUTOMATIC (electrically powered aircraft).

1. Open the service panel access door.
2. Remove fill nipple cap.
3. Connect fill service hose.
4. Turn the handle for the fill valve "*Fill Handle Valve*" to PULL TO FILL position and pull.

5. Select the water quantity foreseen for type of flight (75% is the standard quantity already included in the adjustment values) on "*Pre-Selector Switch*". Fill the tanks, the water pressure must not exceed 125 PSI. Once the water quantity matches the selected quantity the handle automatically returns on NORMAL position.

6. Close water supply valve and remove the service hose.
7. Check that there's no leakage of water from the fill valve.

Note: In case of leakage inform a Company representative.

8. Install cap on fill nipple.
9. Close and latch the service panel.

MANUAL

1. Open the service panel access door.
2. Remove fill nipple cap.
3. Connect fill service hose.
4. Turn the handle for the fill valve "*Fill Handle Valve*" to PULL TO FILL position and pull.
5. Open potable water source valve, the water pressure must not exceed 125 PSI.
6. Stop the procedure to fill the water tanks when water flows from the "*Overflow Port*". Turn the handle manually on NORMAL position.
7. Remove the service hose.
8. Check that there's no leakage of water from the fill valve.

Note: In case of leakage inform a Company representative.

9. Install cap on fill nipple.
10. Close and latch the service panel.

 Volume II HLM	INFORMATION PER AIRCRAFT TYPE	5.1	Page 31
	A-350 - ITA	Ed 2/20 apr 2022	

5.1.8.1 Potable water servicing panel

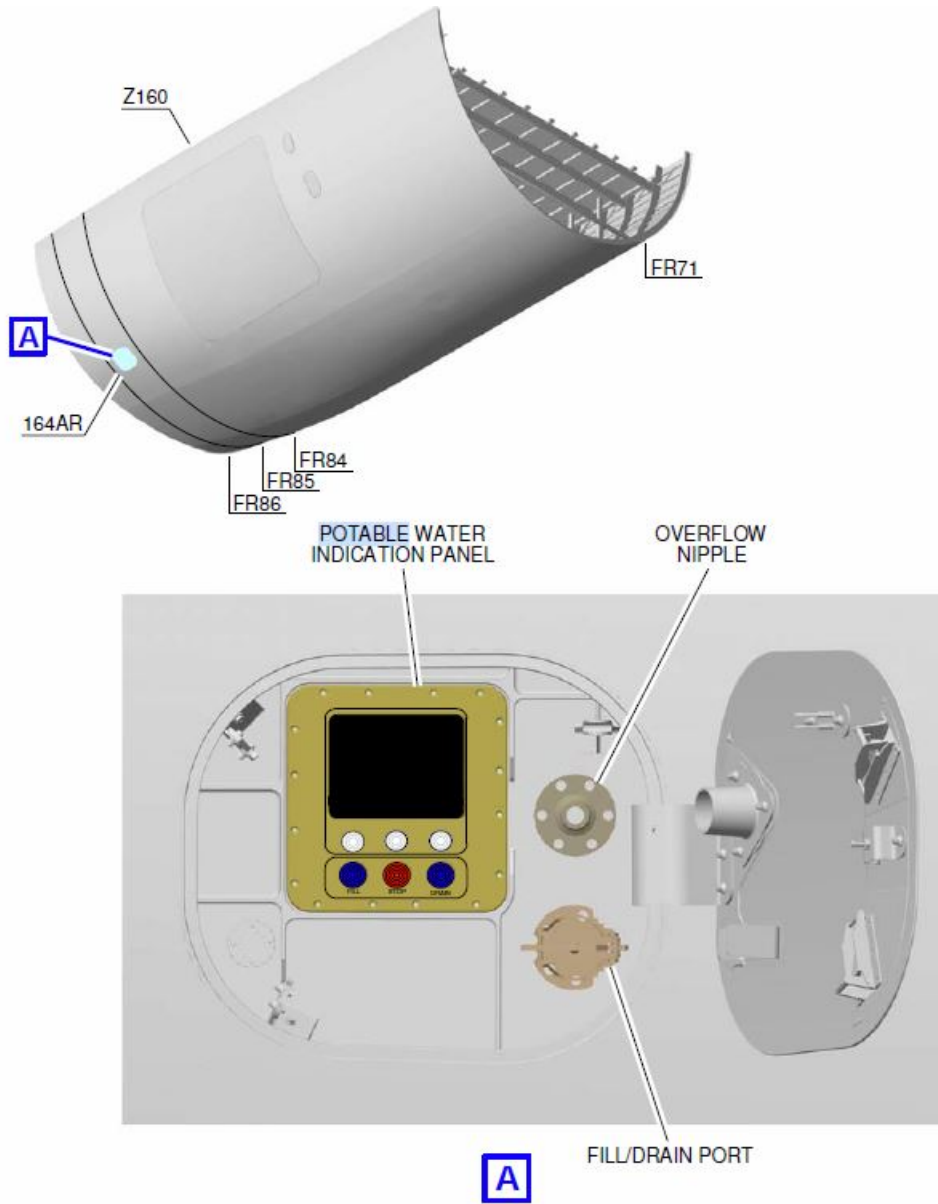

 ITA AIRWAYS Volume II HLM	INFORMATION PER AIRCRAFT TYPE	5.1	Page 32
	A-350 - ITA	Ed 2/20 apr 2022	

5.1.9 SAFETY AREAS

5.1.9.1 Idle thrust - Intake and Blast areas

The Intake and Blast areas at Idle thrust of the aircraft must be observed and no personnel and equipment must stay within these areas when the engines are operating.

The Blast areas refer to the area behind the aircraft, starting from the aft end of operating engines. The safety distances shown in the table below must be observed.

IDLE THRUST (length of danger areas)		
- A - INTAKE AREA	- B - BLAST AREA	- C -
4.6 m	67.0 m	1.6 m

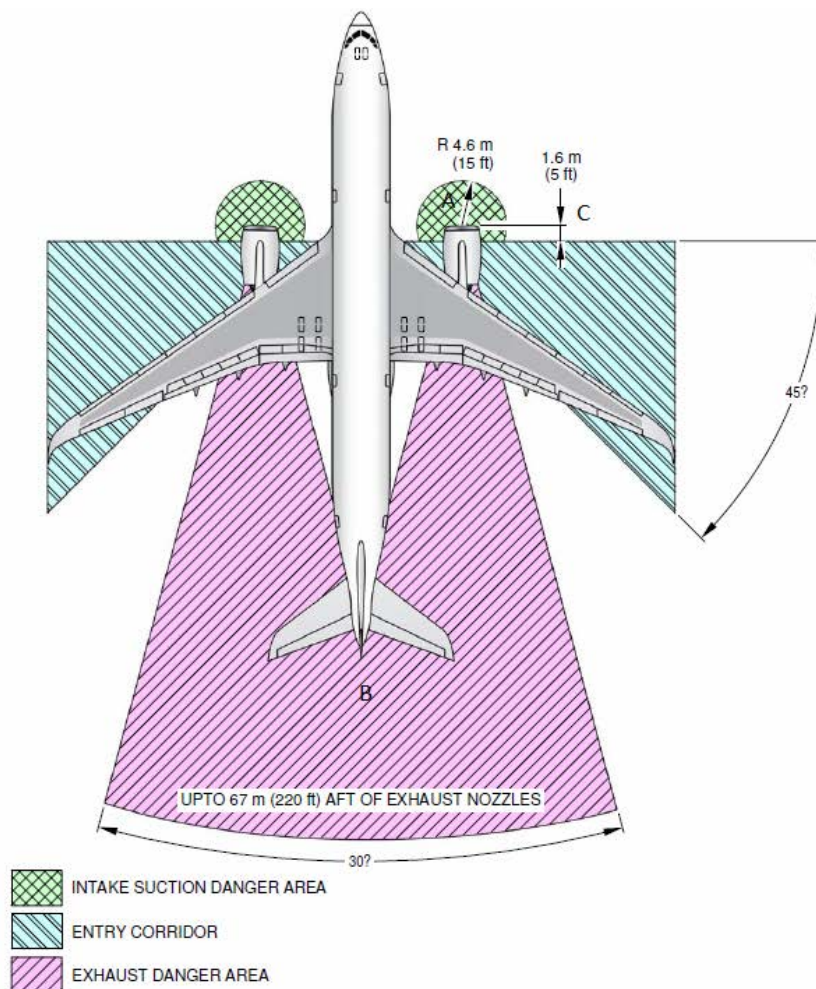

5.1.10 Steering limits

steering angle	right main landing gear (RMLG)	left main landing gear(LMLG)	nose landing gear (NLG)	wing	nose	tail
20	76.3 m	86.9 m	86 m	113.6 m	87.1 m	96 m
25	58.7 m	69.3 m	69.6 m	96.2 m	71.2 m	79.7 m
30	46.7 m	57.3 m	58.9 m	84.3 m	60.8 m	69 m
35	38 m	48.6 m	51.5 m	75.7 m	53.7 m	61.5 m
40	31.1 m	41.7 m	45.9 m	68.9 m	48.5 m	55.9 m
45	25.7 m	36.3 m	41.8 m	63.7 m	44.7 m	51.7 m
50	21.1 m	31.7 m	38.6 m	59.2 m	41.8 m	48.3 m
55	17.4 m	28 m	36.2 m	55.5 m	39.6 m	45.7 m
60	14.1 m	24.7 m	34.3 m	52.4 m	38 m	43.5 m
65	11.4 m	22 m	32.9 m	49.8 m	36.7 m	41.9 m
70	9.2 m	19.8 m	31.9 m	47.7 m	35.9 m	40.6 m
72 (MAX)	8.5 m	19.1m	31.6m	47 m	35.6 m	40.2 m

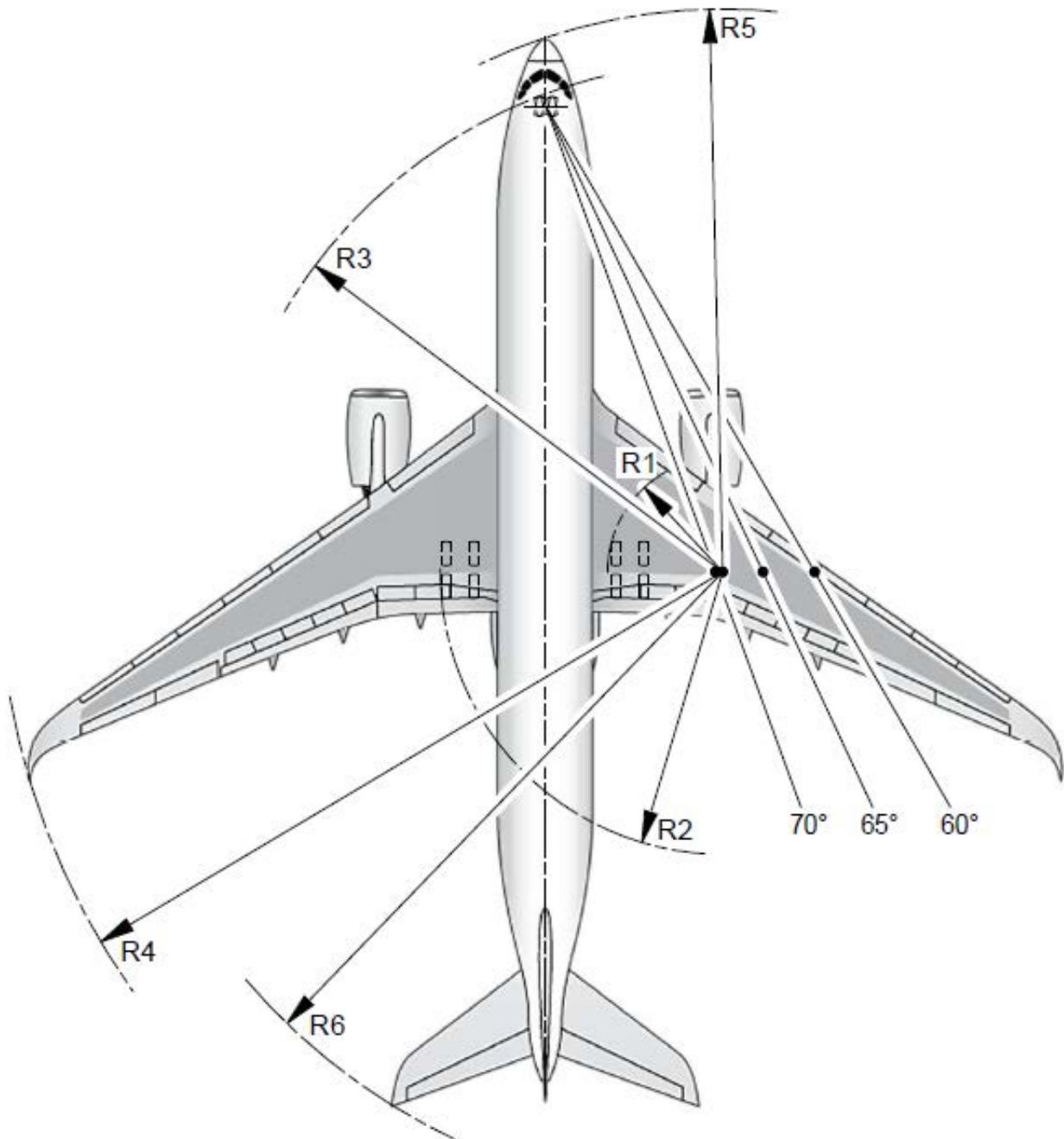

 ITA AIRWAYS Volume II HLM	INFORMATION PER AIRCRAFT TYPE	5.2	Page 1
	A330-900 ITA	Ed 2 Rev 14/05 jun 25	

5.2 A330-900 ITA

5.2.1 HOLDS

5.2.1.1 Cargo compartments specifications

CARGO COMPARTMENT SPECIFICATIONS A-330 900	
MAX CARGO/BAGS CAPACITY	43.313 Kg
MAX CARGO/BAGS VOLUME	128,7 m ³
FORWARD HOLD (compartments 1-2)	<ul style="list-style-type: none"> • Up to 6 PALLET 88" / 96" (PAG-PMC) • Up to 18 CONTENITORI AKE • Up to 9 PALLET 60,4 (PLA)
AFT HOLD (compartments 3-4)	<ul style="list-style-type: none"> • Up to 4 PALLET 88" (PAG) • Up to 3 PALLET 96" (PMC) • Up to 12 CONTAINER AKE • Up to 6 PALLET 60.4" (PLA)
BULK HOLD (compartment 5)	Kg 3.468 - Volume 19,5 m ³ - BULK LOAD

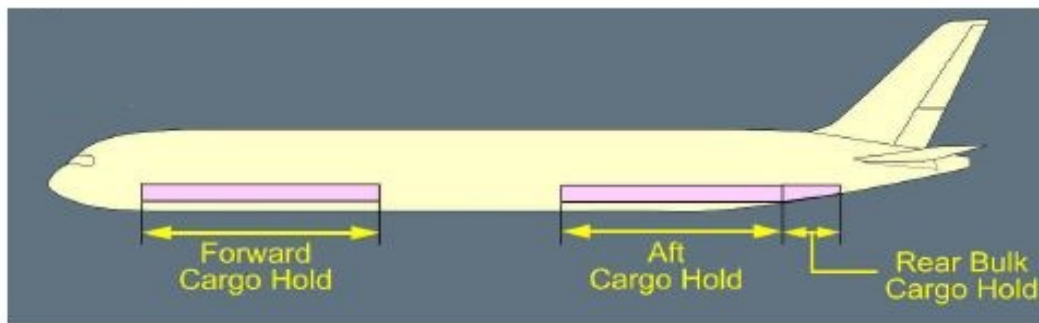

	H-ARMS			
	From		To	
	(m)	(in)	(m)	(in)
Forward cargo hold (Compartments 1 and 2)	14.459	569.25	29.477	1 160.51
Aft cargo hold (Compartments 3 and 4)	39.991	1 574.45	52.315	2 059.65
Rear bulk cargo hold (Compartment 5)	52.315	2 059.65	56.354	2 218.66

 Volume II HLM	INFORMATION PER AIRCRAFT TYPE	5.2	Page 2
	A330-900 ITA	Ed 2 Rev 3/26 may 23	

ULD positions in FORWARD COMPARTMENTS:

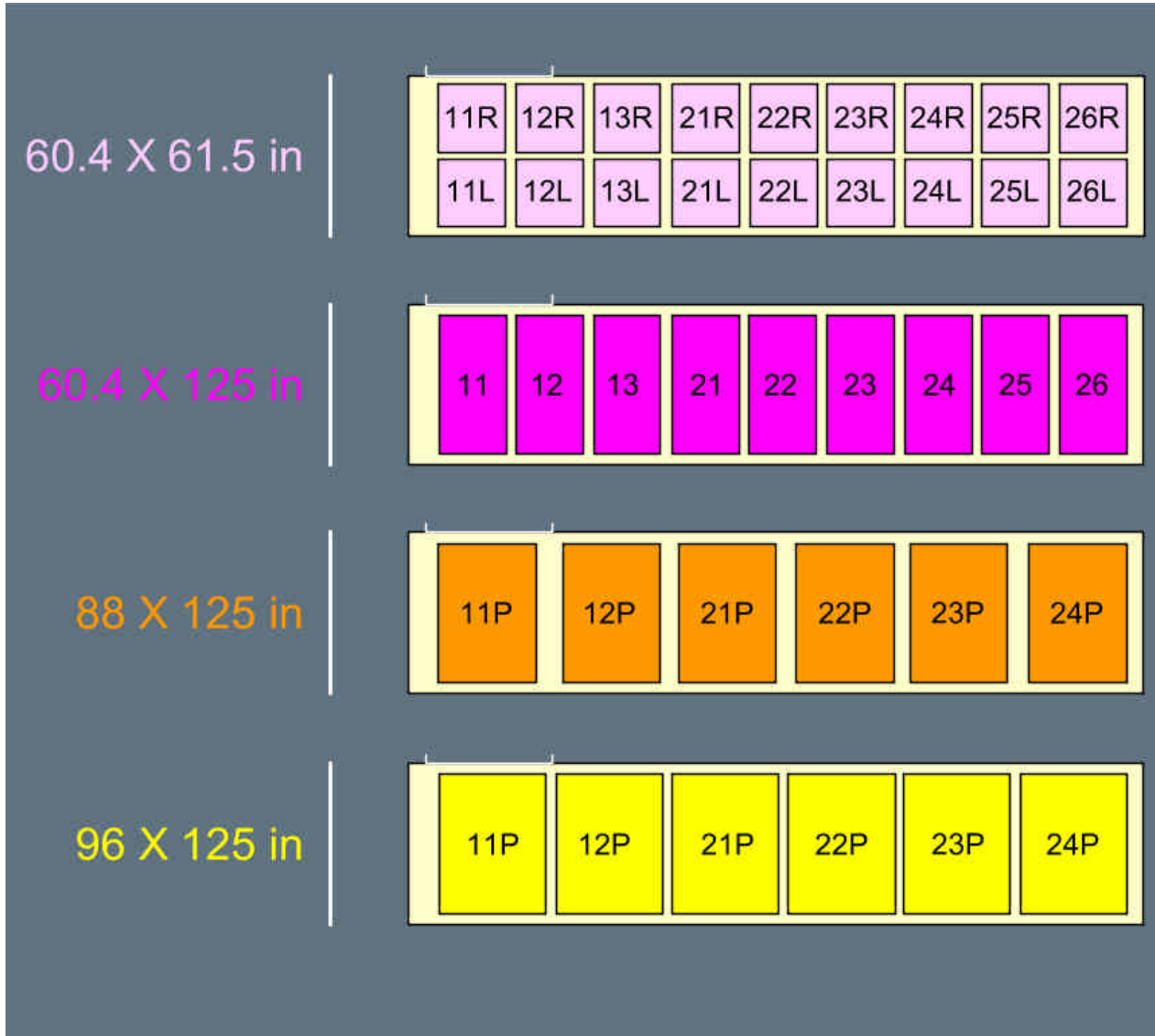

Pallet height must not exceed 162.5 cm (64 inches)

ULD positions in AFT COMPARTMENTS:



Pallet height must not exceed 162.5 cm (64 inches)



LDMRC (Lower Deck Module Rest Container) is installed in pos 31. As fixing hooks between pos 31 and 32 are double use, before loading an ULD and just after offloading it, it is mandatory to check the integrity of the hooks and eventually advise Company and technician.

 Volume II HLM	INFORMATION PER AIRCRAFT TYPE	5.2	Page 4
	A330-900 ITA	Ed 2 Rev 3/26 may 23	



Due to LDMRC installation it is mandatory to respect the following limitations:
 NO ICE in pos 3-4
 NO RRY, RCL e HUM in pos 32 and 33
 NO high density cargo (360kg per cubic meter) and piercing cargo for shape and dimensions



Attention: the LDMCR door shall always be closed before starting loading (CLS will be automatically inhibited). It is forbidden to open the door if not authorized. If CLS is not working, before alerting technician, check if the door is not closed properly.

 Volume II HLM	INFORMATION PER AIRCRAFT TYPE	5.2	Page 5
	A330-900 ITA	Ed 2 Rev 5/02 nov 23	

Aft hold loading configurations:

COMPARTMENT 3 - 4									
ULD base 88"/96"x125"				container AKE or PLA base					
32P	33P	41P	42P	32 L/R	33 L/R	34 L/R	41 L/R	42 L/R	43 L/R
88	88	88	88						
96	88	88	88						
96	88	88							ake
96	88	88							pla
96	88						ake	ake	ake
96	88						pla	pla	pla
88	96						ake	ake	ake
88	96						pla	pla	pla
88	96	88	96						
88	96	88	88						
96	88	88	96						
96		96	96						
96		96	88						
				ake	ake	ake	ake	ake	ake
				pla	pla	pla	pla	pla	pla

 Volume II HLM	INFORMATION PER AIRCRAFT TYPE	5.2	Page 6
	A330-900 ITA	Ed 2 Rev 3/26 may 23	

Compartment 5 “Bulk” is reserved for bulk loads and is divided in 3 sections: 51, 52 and 53.

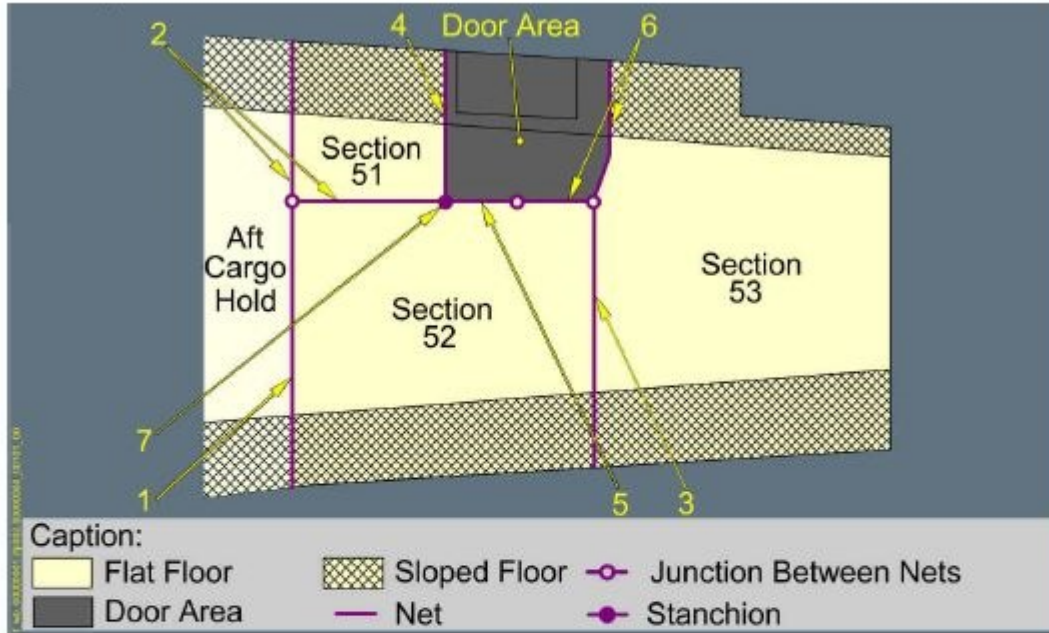

Legend	Related Net Type
1	Divider net 1
2	Corner net
3	Divider net 2
4	Door net type A
5	Door net type C
6	Door net type B
7	Stanchion

 Volume II HLM	INFORMATION PER AIRCRAFT TYPE	5.2	Page 7
	A330-900 ITA	Ed 2 Rev 17/27 jan 26	

Forward and aft loading compartment configurations are flexible as they allow a miscellaneous of **intermix between pallet base 88”/96”x125”** (PAG, PMC, RAP, AAP, AMP, PAJ) **or between container AKE and PLA.**

COMPARTMENT	SURFACE RESISTANCE (Kg/m ²)	LINEAR RESISTANCE (Kg/m)	USABLE VOLUME (m ³)	MAX STRUCTURAL LOAD (Kg)	
1	659	2.070	25,8	10.206	22.861
2			51,6	20.412	
3			25,8	9.729	16.984
4			25,8	10.206	
51	732		1,8	339	3.468
52			7,8	1.413	
53			9,9	1.716	



Due to fire extinguishing system feature, shipments containing Dangerous Goods (DG) as flammable and combustibles (class 2.1, 3 and 4) shall be loaded necessarily in the compartments 3 and 4. Segregation criteria shall be always respected (i.e. in case of DG class 2.1, 3 and 4, lithium-ion, lithium metal and sodium-ion batteries shall be loaded exclusively in the compartments 1-2).

Cargo holds are pressurized and have the following systems installed:

- smoke detection system,
- fire extinguishing system,
- ventilation system (compartments 1 - 2 - 5).

MAXIMUM ULD LOAD PER POSITION (Kg)			
Dimensioni base ULD (inches)			
88 x 125 (PAG-AAP-RAP-PAJ)	96 x 125 (PMC-AMP)	60.4 x 61.5 (AKE)	60.4 x 125 (PLA)
4.626	5.102	1.587	3.174

 ITA AIRWAYS Volume II HLM	INFORMATION PER AIRCRAFT TYPE	5.2	Page 8
	A330-900 ITA	Ed 2 Rev 3/26 may 23	

5.2.1.2 Cargo compartment temperature and ventilation

The following table shows all necessary information for the transportation of goods that need specific temperature and ventilation on board this kind of aircraft.

BAGAGLIAIO	RANGE DELLE TEMPERATURE	POSSIBILITÀ VENTILAZIONE	CONTROLLO DA TERRA	CONTROLLO DA COCKPIT
1 - 2	5°C - 25°C	YES	NO	YES
3 - 4		NO	NO	NO
5	5°C - 25°C	YES	NO	YES

Note: *Damaged or missing separation net or cover will restrict the performance of compartment 5 ventilation system*

5.2.1.3 Resistance of fittings

All compartments can host single tie-down fittings for the restraint of bulk loads. The following table shows the fittings minimum resistance in every direction..

COMPARTMENT	MINIMUM RESISTANCE
1 - 2 - 3 - 4 - 5	5000 LB / 2267 Kg

The resistance can be calculated by multiplying the fittings resistance by the coefficient related to the angle (9.3.3 LOAD RESTRAINT FACTORS).

DIRECTION	COMPARTMENT	RESTRAINT FACTOR
FORWARD	ALL	1,5 G
BACKWARD	ALL	0,8 G
RIGHT - LEFT	1 - 2	0,89 G
	3 - 4	1,28 G
	5	1,55 G
UPWARD	1 - 2	1,5 G
	3 - 4	1,88 G
	5	2,24 G

5.2.1.4 Forward hold (compartment 1-2) cargo door maximum dimensions

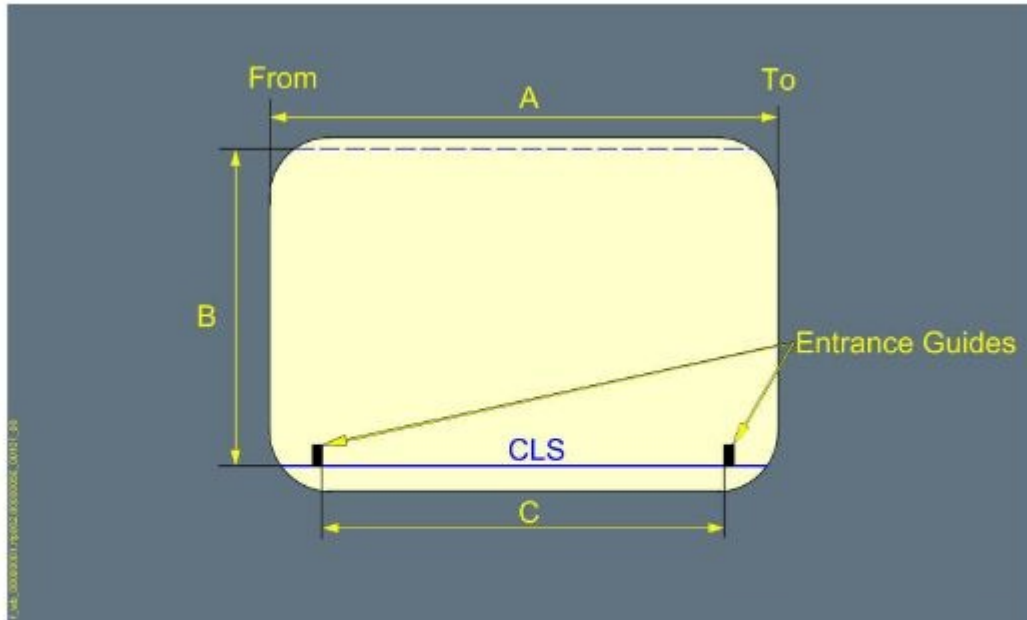

Legend		Dimensions	
		(m)	(in)
A	Clear opening width	2.701	106.34
B	Clear opening height	1.699	66.89
C	Door width at CLS level	2.446	96.30

5.2.1.5 Aft hold (compartment 3-4) cargo door maximum dimensions

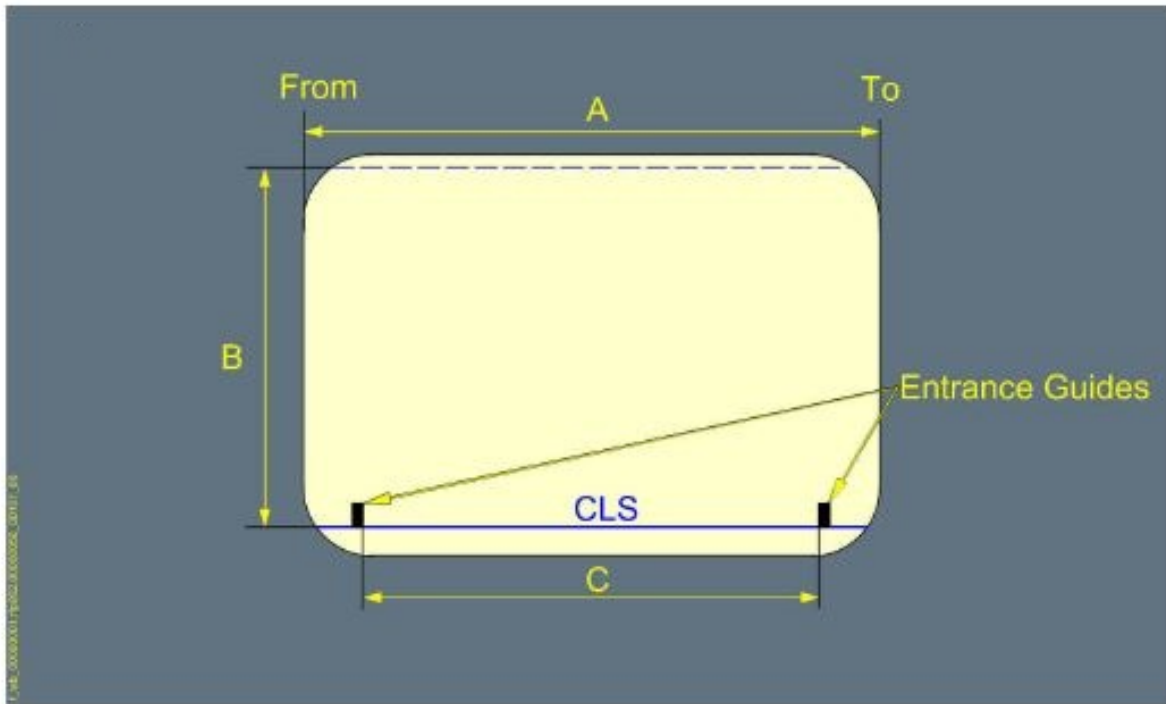

Legend		Dimensions	
		(m)	(in)
A	Clear opening width	2.721	107.13
B	Clear opening height	1.682	66.22
C	Door width at CLS level	2.446	96.30

5.2.1.6 Bulk hold (compartment 5) cargo door maximum dimensions

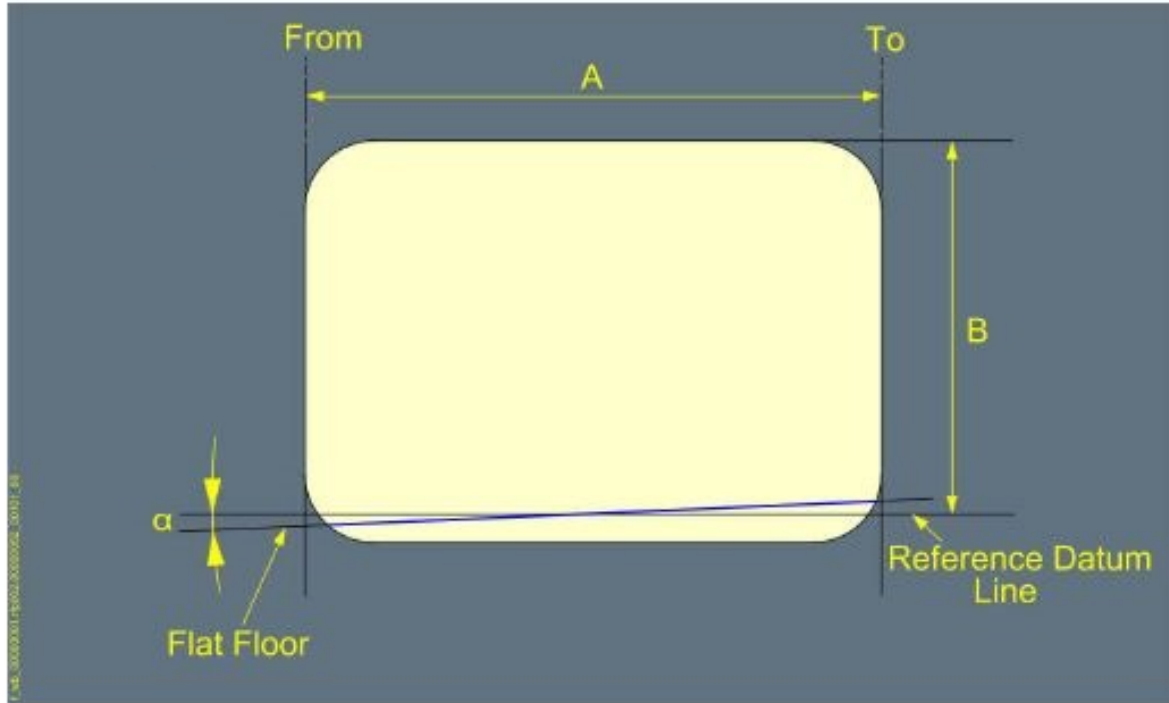

Legend		Dimensions		
		(m)	(in)	(Degree)
A	Clear opening width	0.950	37.40	-
B	Clear opening height	0.620	24.41	-
α	Angle between the flat floor and the reference datum line	-	-	1.20

 Volume II HLM	INFORMATION PER AIRCRAFT TYPE			5.2	Page 12
	A330-900 ITA			Ed 2 Rev 3/26 may 23	

5.2.1.7 Maximum dimensions for conventional load in compartment 5

The maximum dimensions of cargo packages which will pass through the bulk cargo door (compartment 5) are shown in the following tables:

- A. **Table 1 - for upright loading**
- B. **Table 2 - for upright and for tilted loading**

These dimensions are approximate values and refer to rectangular packages. Vertical loading shall be applied to heavy items that can be loaded only with the support of mechanical equipment (fork-lift) and shall be positioned alongside with the pavement.

Tabella 1

HEIGHT (cm)	Section 51, 52, 53	10 - 56					
WIDTH (cm)	Section 51, 52, 53	10	25	40	55	70	85
LENGTH (cm)	Section 51	<i>trial loading recommended</i>					
	Section 52	240	225	210	200	180	180
	Section 53	250	235	225	210	210	210

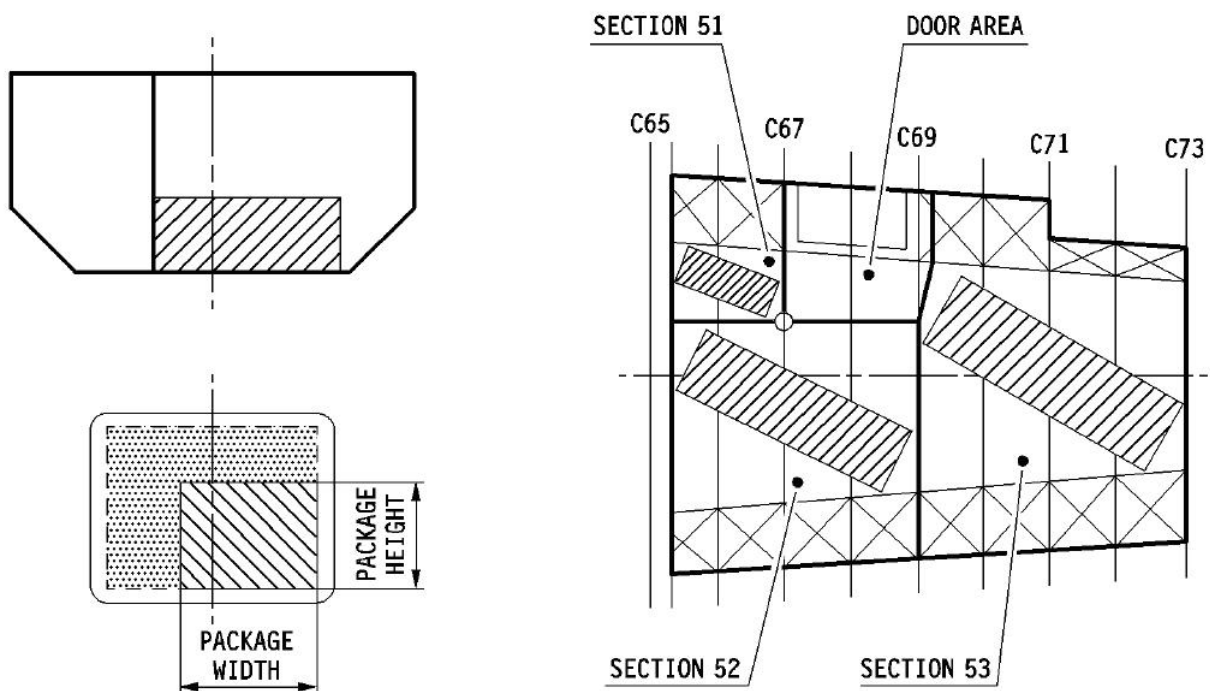

 ITA AIRWAYS Volume II HLM	INFORMATION PER AIRCRAFT TYPE			5.2	Page 13
	A330-900 ITA			Ed 2 Rev 3/26 may 23	

5.2.1.7.1 B) Upright loading and tilted loading

Upright loading and tilted loading applies to low density packages (weighing less than 150 Kg), which can be manoeuvred by hand. For loading the packages with maximum dimensions shown in table 2 it is not necessary to tilt the packages, but they must be lifted on the sloping part of the floor (provided that the package does not have a rigid structure).

Table 2

HEIGHT (cm)	Section 51, 52, 53	10 - 56						< 10
WIDTH (cm)	Section 51, 52, 53	10	25	40	55	70	85	100
LENGTH (cm)	Section 51	<i>trial loading recommended</i>						
	Section 51	280	270	250	250	225	225	225
	Section 51	290	280	270	260	250	250	250

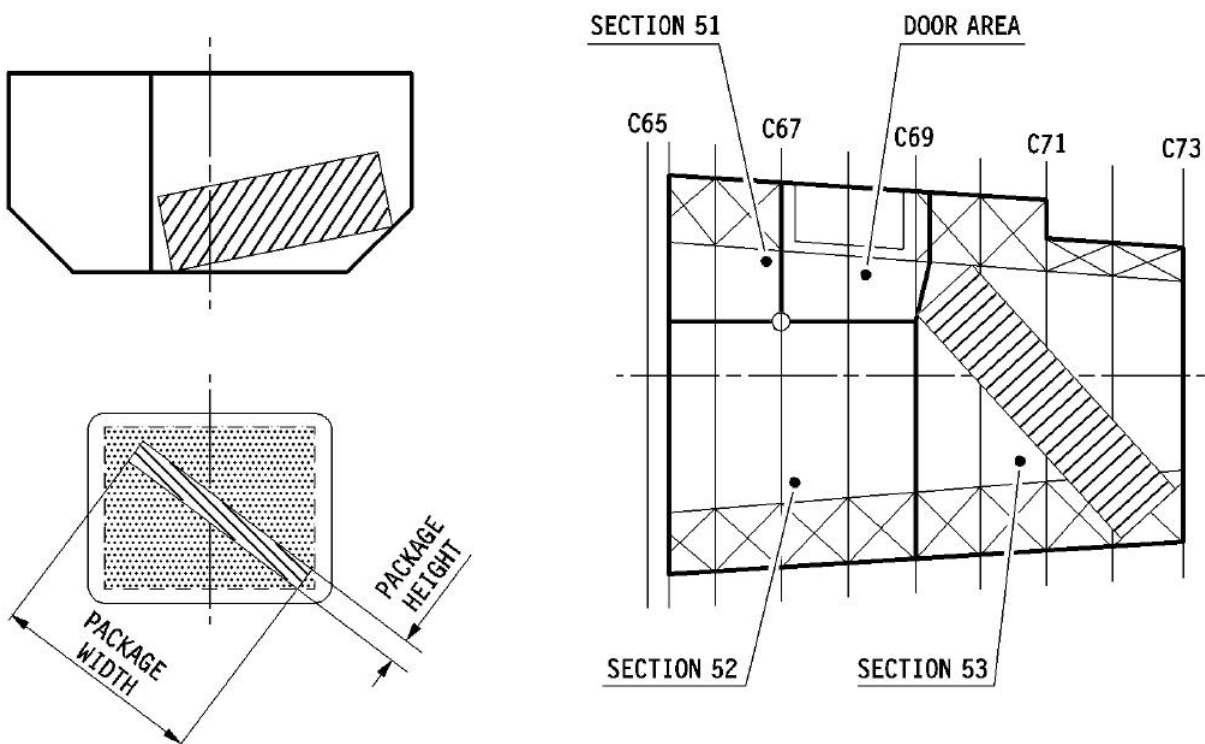

 Volume II HLM	INFORMATION PER AIRCRAFT TYPE	5.2	Page 14
	A330-900 ITA	Ed 2 Rev 3/26 may 23	

5.2.1.8 Cross section of compartments 1-2-3-4 - internal dimensions for the loading of conventional loads

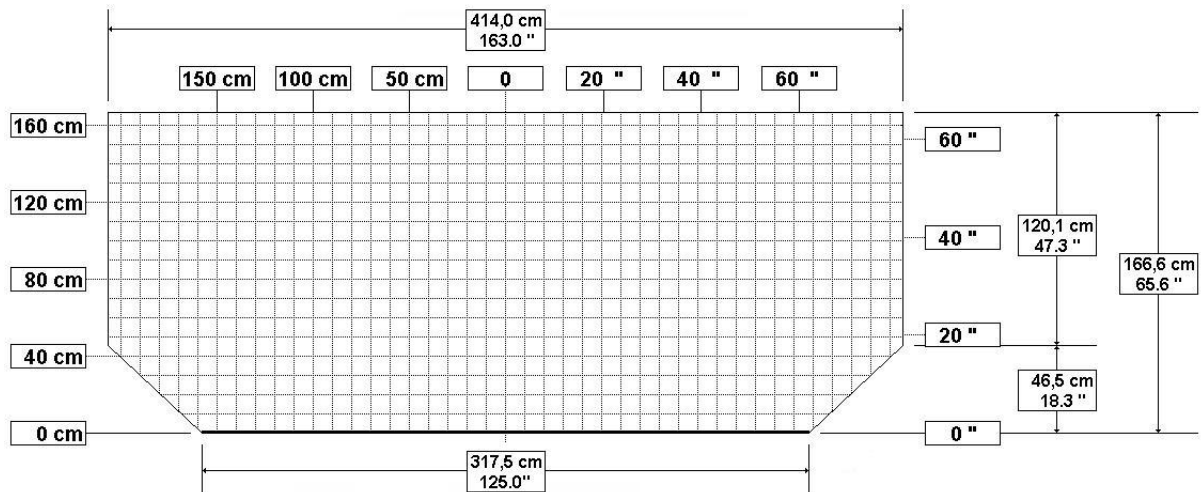

Notes:

- the side of each square is 10 cm (4,0") long,
- those given are the maximum dimensions: pallets must be built up in such a way as to keep the 5 cm / 2" minimum clearance from ceiling lights, smoke detectors and compartment contour,
- the pallet is about 2,5 cm (1") thick, and should be subtracted from the available height.

Overhangs on short sides of pallet based 88"/96"x125" are allowed

Overhangs on long side (125") of pallet based 88"x125" are allowed up to 8" (20 cm) provided that the overhang is not positioned next front / rear bulkheads and that a related obliged clearance is built in the adjoining pallet, if necessary

Overhangs on long side (125") of pallet based 96"x125" are not allowed

 ITA AIRWAYS Volume II HLM	INFORMATION PER AIRCRAFT TYPE		5.2	Page 15
	A330-900 ITA			Ed 2 Rev 3/26 may 23

5.2.2 FUEL

The fuel is contained in six tanks, two in each cantilever wing box, one in the wing box center section and one in the horizontal tail plane.

Layout and identification of these tanks are shown in the illustration below.

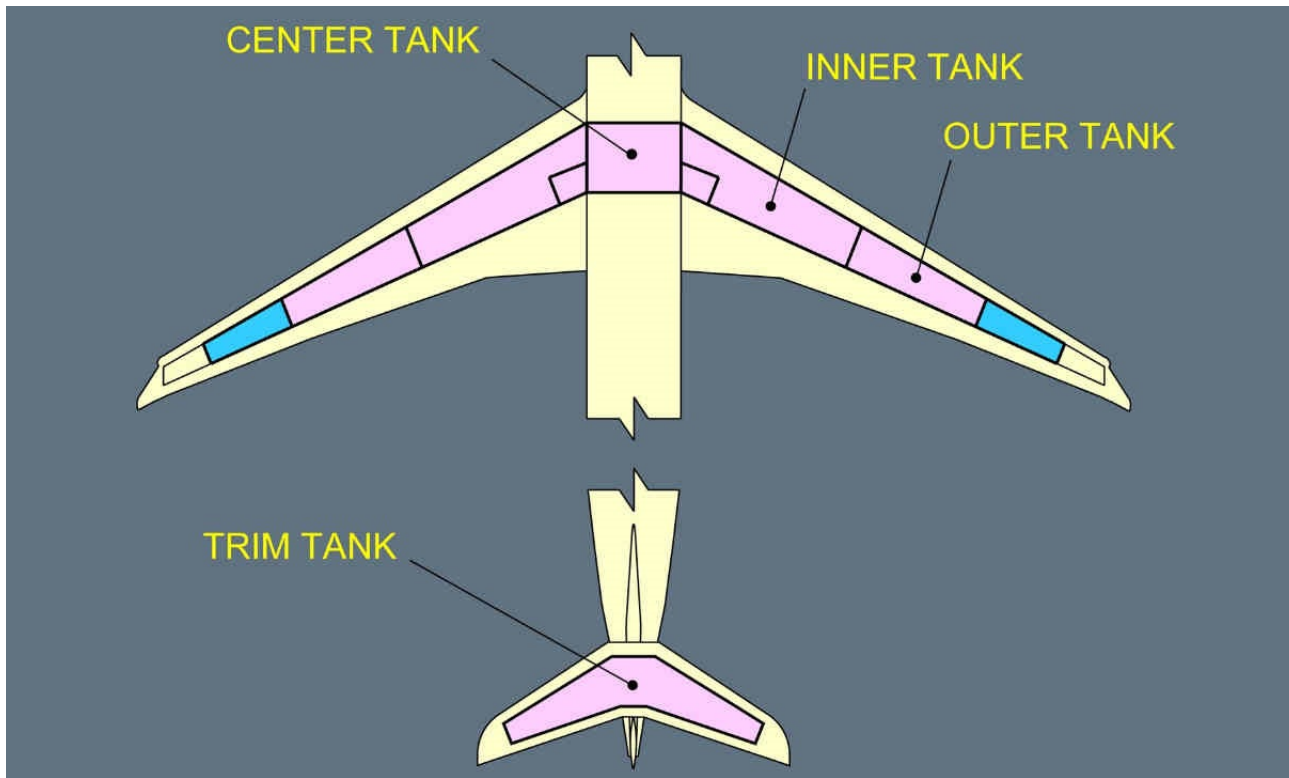

	A330-900 FUEL TANKS CAPACITY						
	Outer Tank Left	Inner Tank Left	Center Tank	Inner Tank Right	Outer Tank Right	Trim Tank	TOTAL
CAPACITY (Lt.)	3.650	42.000	41.560	42.000	3.650	6.230	139.090
WEIGHT (Kg)	2.865	32.970	32.625	32.970	2.865	4.890	109.185

If, for technical reasons, the fuel distribution in A330 aircraft tanks differs from the standard, the procedure 4.3.3.4 A330 non-standard fuel distribution must be applied.

Fuelling can be performed only on the right side

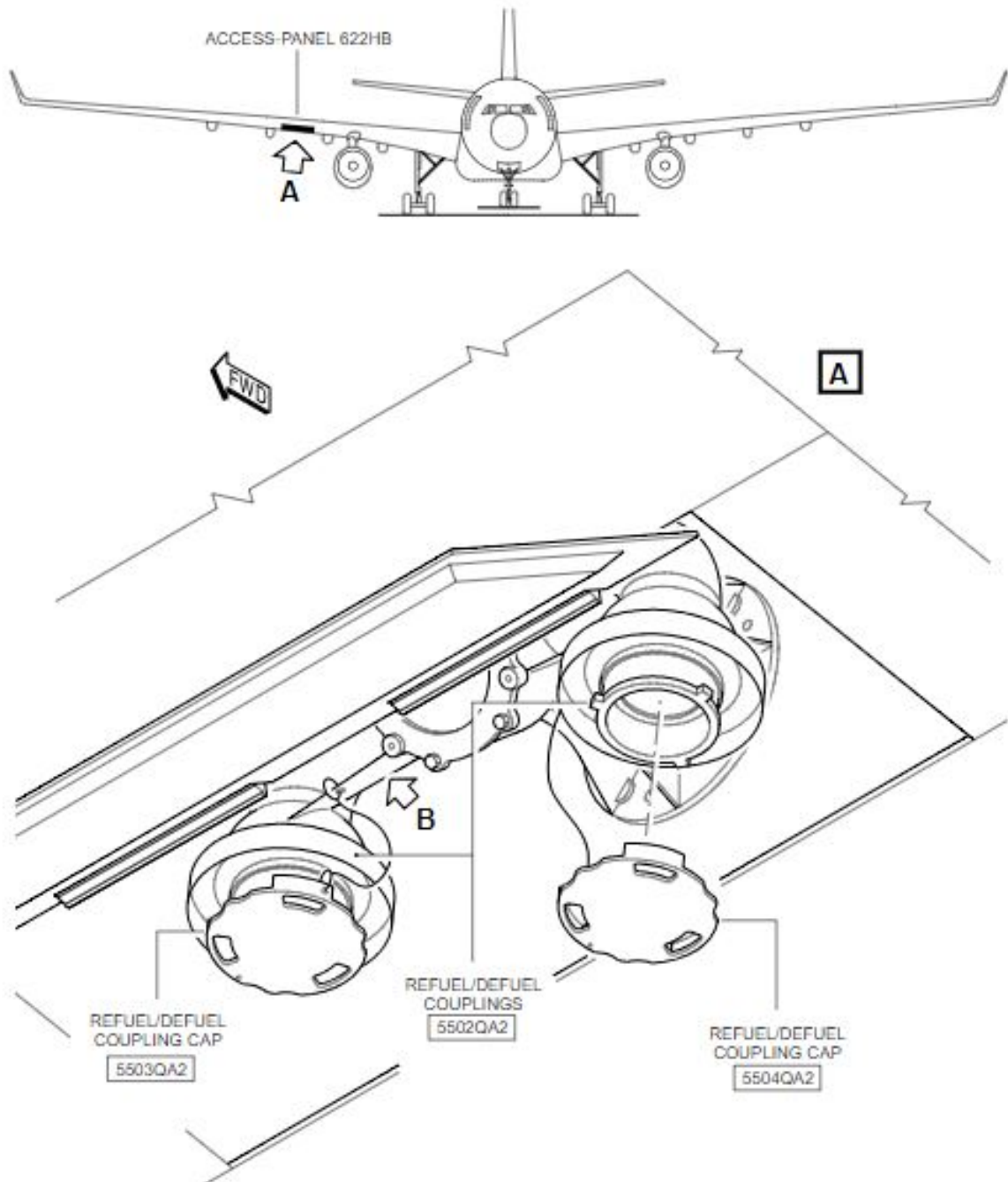

 Volume II HLM	INFORMATION PER AIRCRAFT TYPE	5.2	Page 17
	A330-900 ITA	Ed 2 Rev 3/26 may 23	

5.2.3 USE OF MARKER CONES

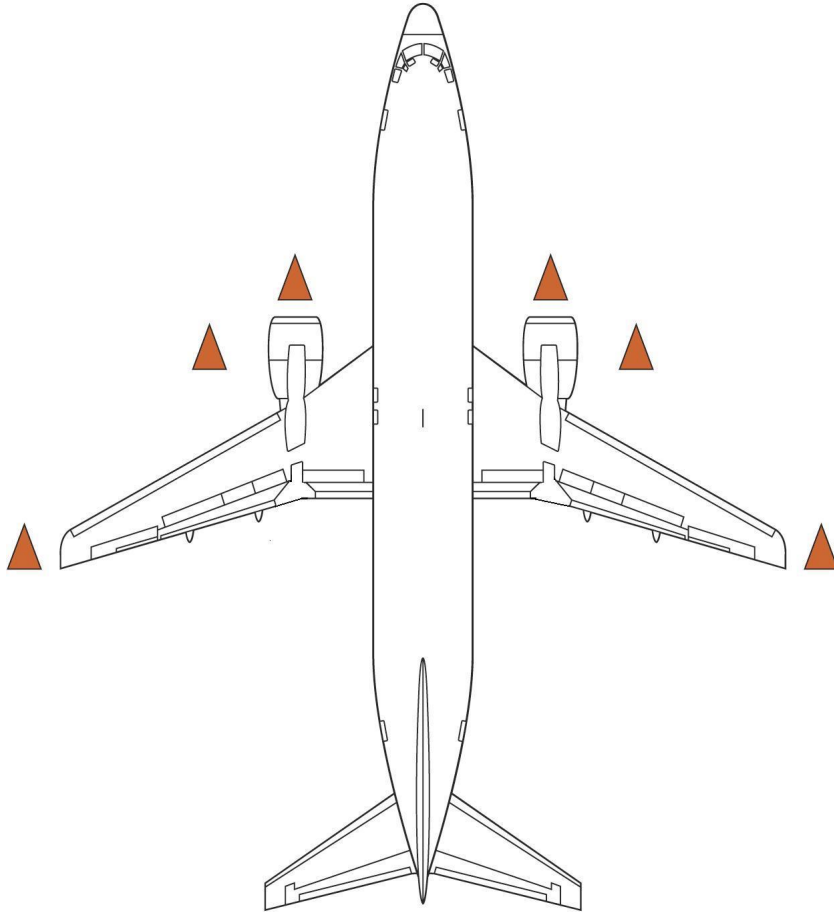

5.2.4 CHOCKING OF AIRCRAFT

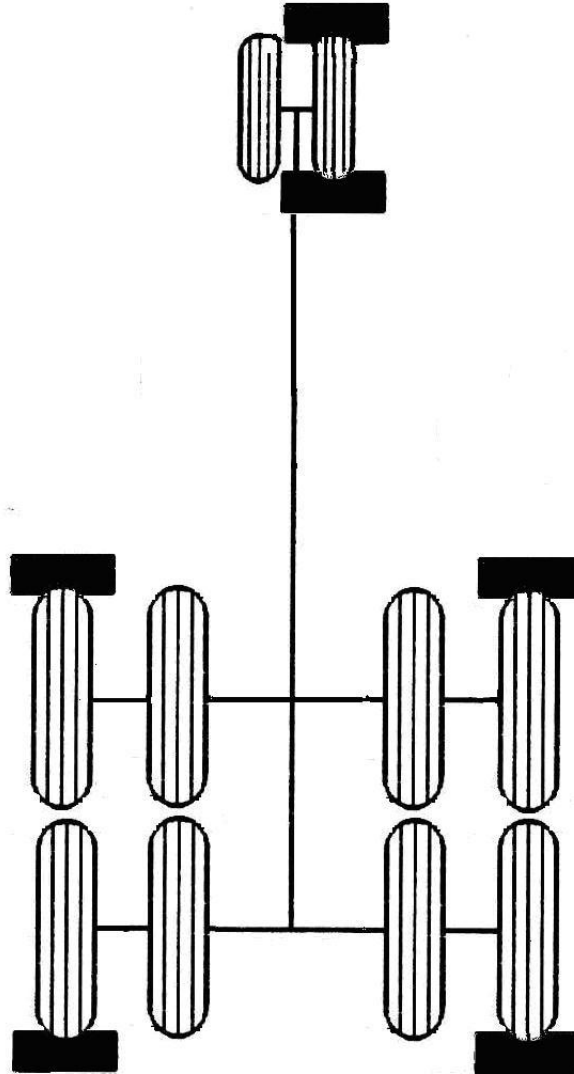

 Volume II HLM	INFORMATION PER AIRCRAFT TYPE	5.2	Page 19
	A330-900 ITA	Ed 2 Rev 3/26 may 23	

5.2.5 Chocking of aircraft with wind over 25kt (46.3 km/h)

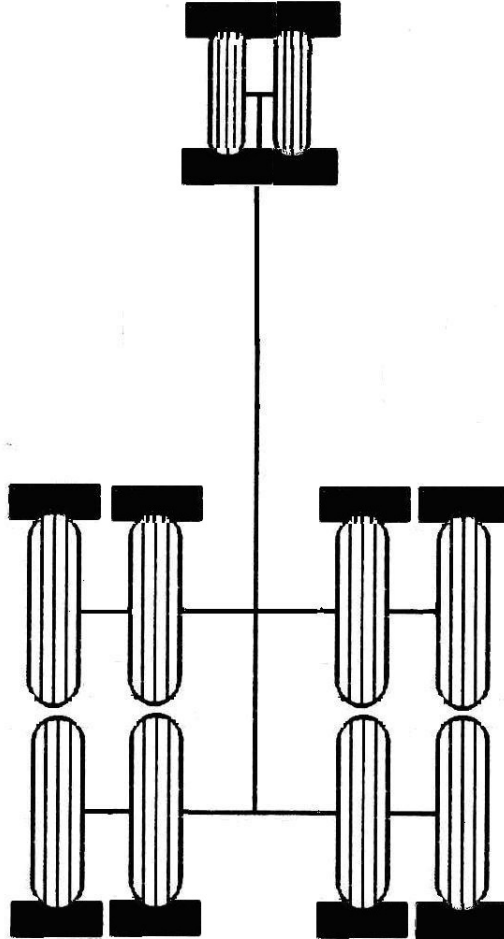

5.2.6 SERVICING ARRANGMENTS

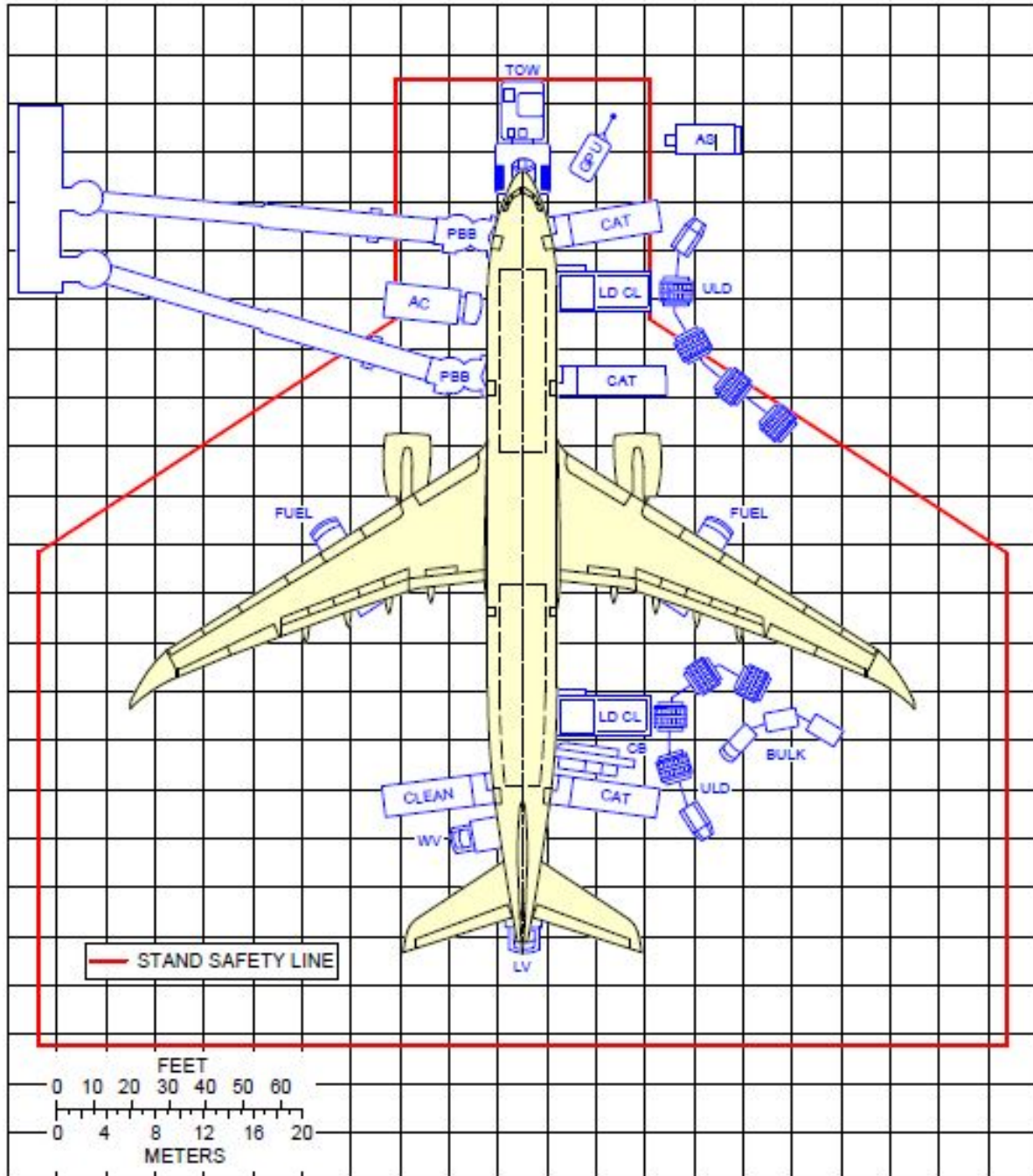

NOTE:
TYPICAL RAMP LAYOUT APPLICABLE TO A330-300 AND A330-900.

 Volume II HLM	INFORMATION PER AIRCRAFT TYPE	5.2	Page 21
	A330-900 ITA	Ed 2 Rev 3/26 may 23	

5.2.7 TOILETTE DRAIN

Below, the description of operational procedures for draining, flushing and filling of the chemical precharge.

1. Open service panel access door.
2. Unlock drain right valve using unlock lever.
3. Connect the waste drain hose coupling to panel drain nipple and assure that the hose is well connected.
4. Turn the left drain handle to unlock and pull until is fully extended.
5. While the tanks drain, feel the drain hose and make sure that all waste is draining out.

Note: If the draining is not performed correctly, inform a Company representative.

6. Turn the right drain handle to unlock and pull until is fully extended.
7. While the tanks drain, feel the drain hose and make sure that all waste is draining out.

Note: If the draining is not performed correctly, inform a Company representative.

8. Connect water supply hose coupling to the left flush nipple.
9. Flush the tank using 100 litres of chemical precharge, the pressure must not exceed 35 PSI.
10. Repeat the operation with the right flush nipple.
11. Close both drain handles valve.
12. Remove the waste drain hose coupling to panel drain nipple and leave the fitting cap opened.
13. Fill 18 litres of disinfectant precharge solution in the right tank, repeat the operation for the left tank.

Note: In case of leakage of chemical precharge from drain valves, inform a Company representative.

14. Closed the valves drain cap and latch the service panel.

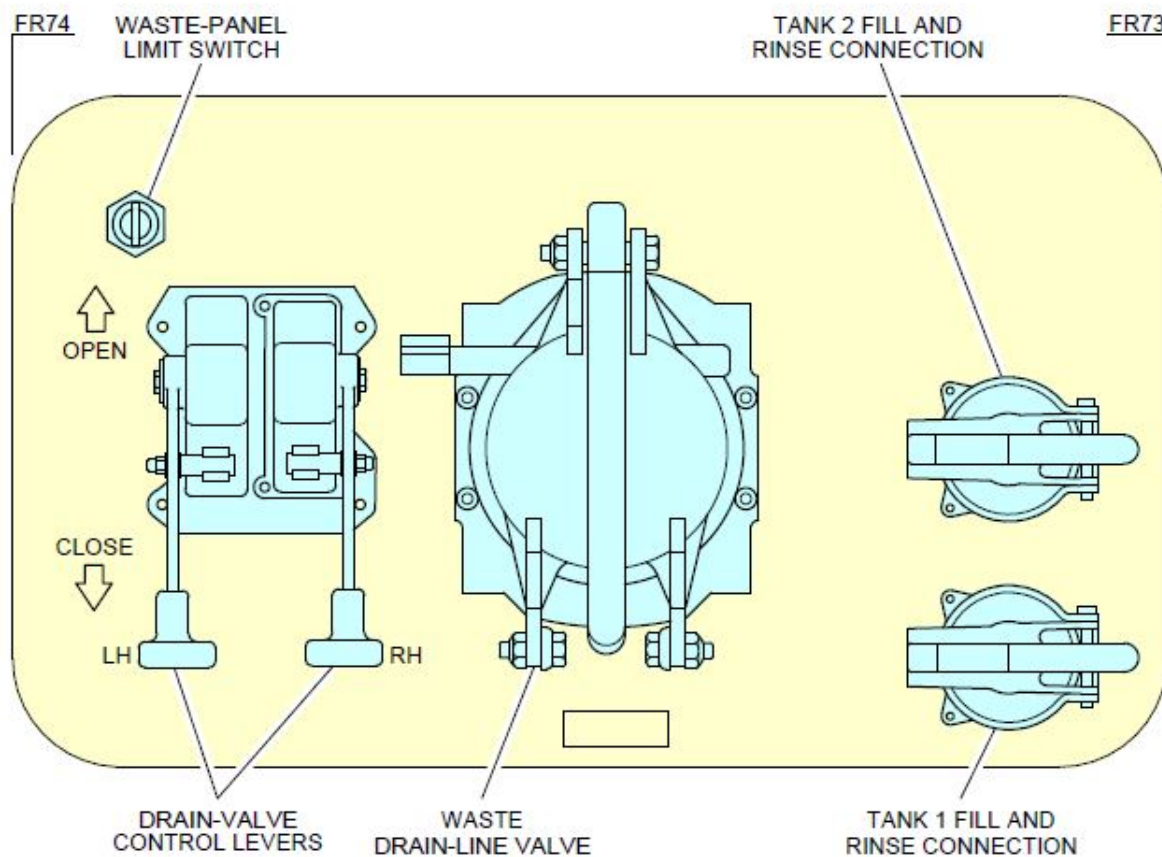
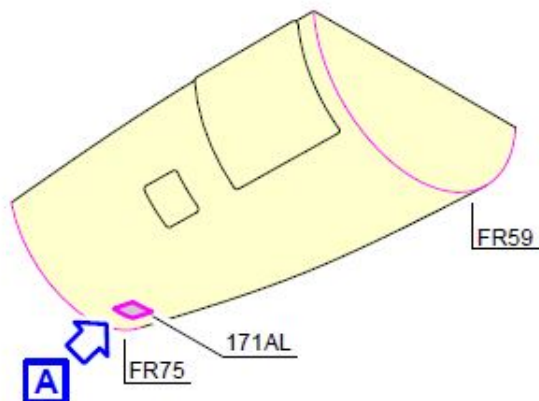

 ITA AIRWAYS Volume II HLM	INFORMATION PER AIRCRAFT TYPE	5.2	Page 23
	A330-900 ITA	Ed 2 Rev 3/26 may 23	

5.2.8 FILLING POTABLE WATER

Potable water service shall always be performed in automatic mode (electrically powered aircraft). If for technical reasons is not possible to operate in automatic mode use manual mode. Adopting this procedure the tanks will be filled to FULL; in this case is mandatory to inform the Flight Deck that the water quantity is up to full.

Below, the description of operational procedures for filling potable water.

AUTOMATIC (electrically powered aircraft).

1. Open the service panel access door.
2. Remove fill nipple cap.
3. Connect fill service hose.
4. Turn the handle for the fill valve "*Fill Handle Valve*" to PULL TO FILL position and pull.

5. Select the water quantity foreseen for type of flight (75% is the standard quantity already included in the adjustment values) on "*Pre-Selector Switch*". Fill the tanks, the water pressure must not exceed 125 PSI. Once the water quantity matches the selected quantity the handle automatically returns on NORMAL position.

6. Close water supply valve and remove the service hose.
7. Check that there's no leakage of water from the fill valve.

Note: In case of leakage inform a Company representative.

8. Install cap on fill nipple.
9. Close and latch the service panel.

MANUAL

1. Open the service panel access door.
2. Remove fill nipple cap.
3. Connect fill service hose.
4. Turn the handle for the fill valve "*Fill Handle Valve*" to PULL TO FILL position and pull.
5. Open potable water source valve, the water pressure must not exceed 125 PSI.
6. Stop the procedure to fill the water tanks when water flows from the "*Overflow Port*". Turn the handle manually on NORMAL position.
7. Remove the service hose.
8. Check that there's no leakage of water from the fill valve.

Note: In case of leakage inform a Company representative.

9. Install cap on fill nipple.
10. Close and latch the service panel.

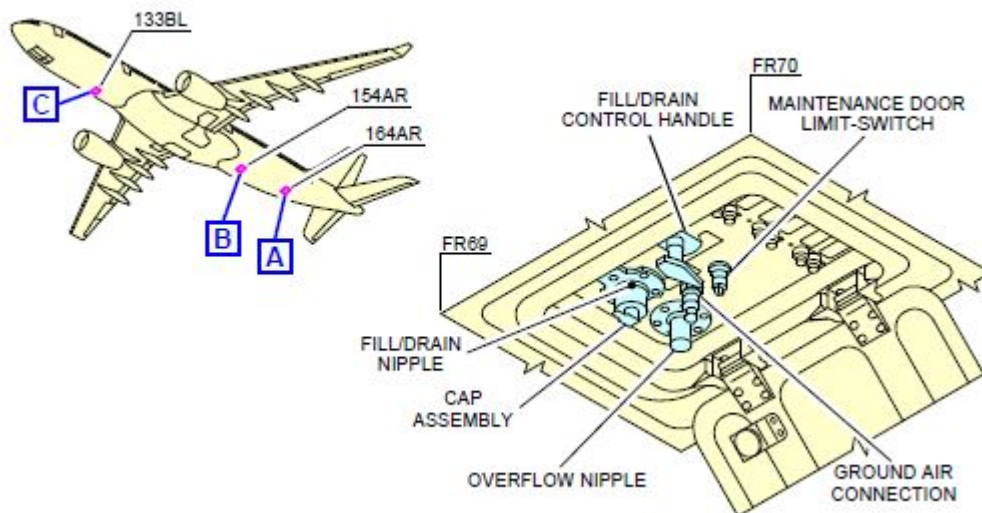

A
POTABLE-WATER SERVICE PANEL

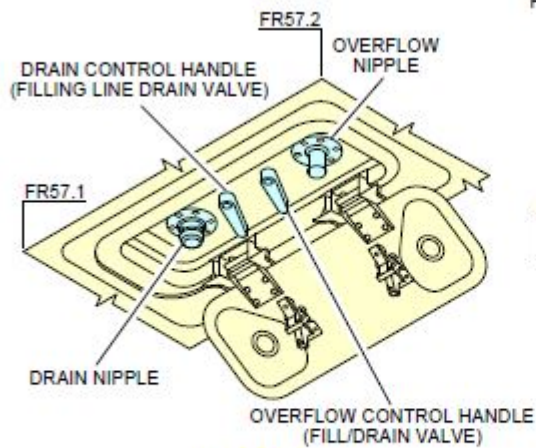

B
AFT POTABLE-WATER DRAIN PANEL

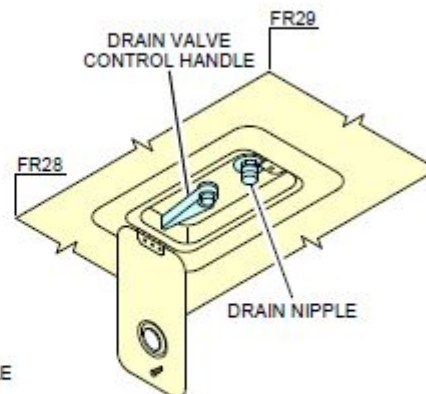

C
FWD POTABLE-WATER DRAIN PANEL

 ITA AIRWAYS Volume II HLM	INFORMATION PER AIRCRAFT TYPE	5.2	Page 25
	A330-900 ITA	Ed 2 Rev 3/26 may 23	

5.2.9 SAFETY AREAS

5.2.9.1 Idle thrust - Intake and Blast areas

The Intake and Blast areas at Idle thrust of the aircraft must be observed and no personnel and equipment must stay within these areas when the engines are operating.

The Blast areas refer to the area behind the aircraft, starting from the aft end of operating engines. The safety distances shown in the table below must be observed.

IDLE THRUST (length of danger areas)		
- A - INTAKE AREA	- B - BLAST AREA	- C -
4.3 m	67.1 m	1.5 m

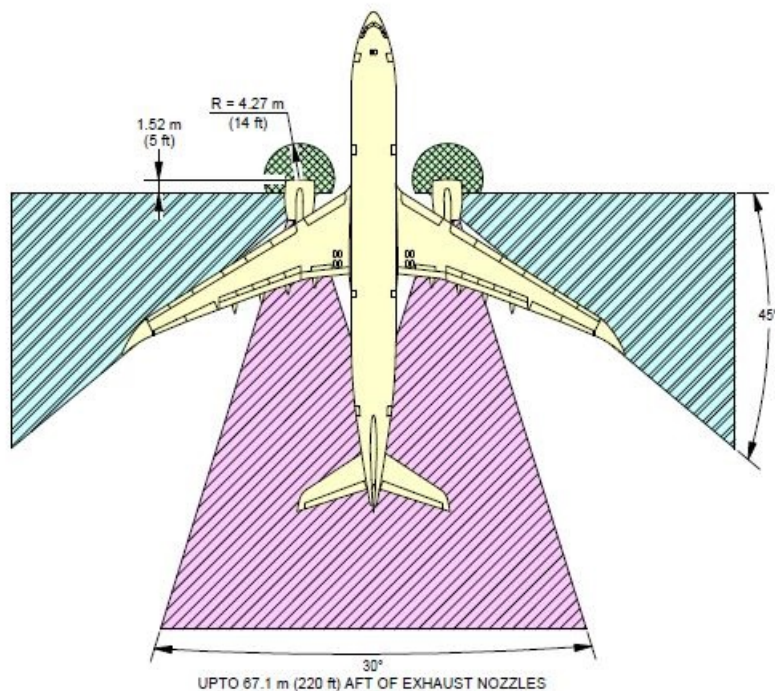

NOTE:

	INTAKE SUCTION DANGER AREA
	ENTRY CORRIDOR
	EXHAUST DANGER AREA

5.2.10 Steering limits

steering angle	right main landing gear (RMLG)	left main landing gear(LMLG)	nose landing gear (NLG)	wing	nose	tail
20	67.7 m	78.4 m	76.9 m	104.7 m	78.9 m	87.7 m
25	52.1 m	62.8 m	62.4 m	89.3 m	64.9 m	73.3 m
30	41.4 m	52.1 m	52.8 m	78.7 m	55.9 m	63.9 m
35	33.5 m	44.2 m	46.1 m	70.9 m	49.6 m	57.2 m
40	27.4 m	38.1 m	41.1 m	64.9 m	45.1 m	52.2 m
45	22.6 m	33.3 m	37.5 m	60.2 m	41.9 m	48.5 m
50	18.6 m	29.3 m	34.6 m	56.3 m	39.5 m	45.5 m
55	15.3 m	26 m	32.5 m	53 m	37.6 m	43.2 m
60	12.5 m	23.2 m	30.8 m	50.4 m	36.2 m	41.4 m
65	10.2 m	20.9 m	29.6 m	48.1 m	35.2 m	39.9 m
72 (MAX)	8.1 m	18.8 m	28.5 m	46.1 m	34.4 m	38.7 m

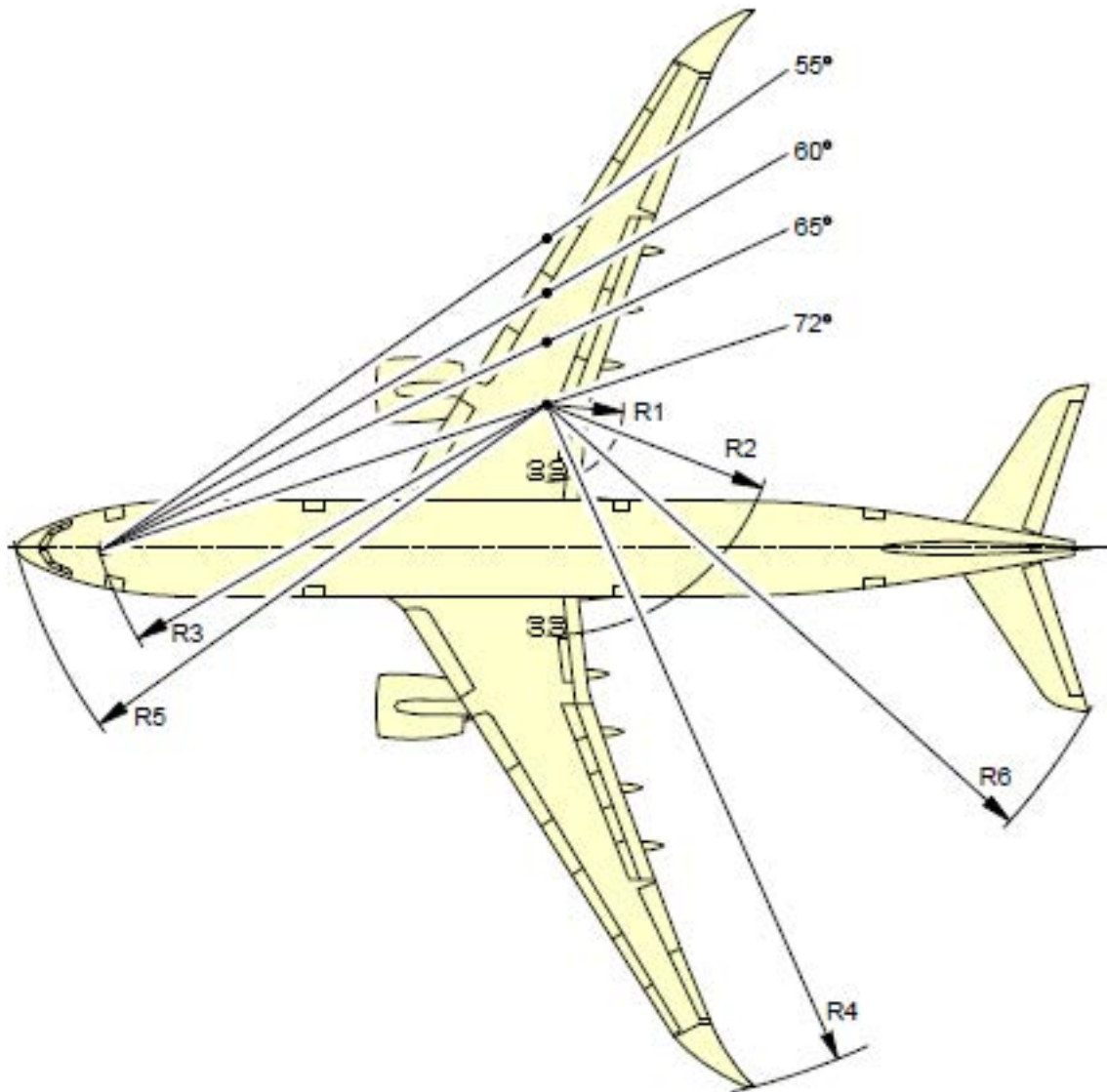

 ITA AIRWAYS Volume II HLM	INFORMATION PER AIRCRAFT TYPE	5.3	Page 1
	A330 202 - ITA	Ed 2/20 apr 2022	

5.3 A330 202 - ITA

5.3.1 HOLDS

5.3.1.1 Cargo compartment specifications

CARGO COMPARTMENT SPECIFICATIONS A-330	
MAX CARGO/BAGS CAPACITY	37.578 Kg
MAX CARGO/BAGS VOLUME	120,3 m ³
FORWARD HOLD (compartments 1-2)	<ul style="list-style-type: none"> • Up to 4 88" / 96" PALLETS in any INTERMIX • Up to 14 AKE CONTAINERS
AFT HOLD (compartments 3-4)	<ul style="list-style-type: none"> • Up to 4 88" / 96" PALLETS in any INTERMIX • Up to 12 AKE CONTAINERS
BULK HOLD (compartment 5)	Kg 3.468 - Volume 19,7 m ³ - BULK LOAD

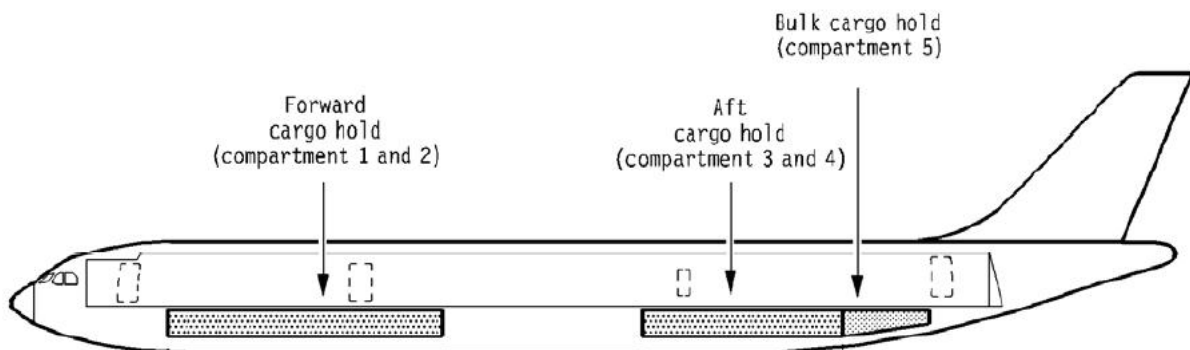

 Volume II HLM	INFORMATION PER AIRCRAFT TYPE	5.3	Page 2
	A330 202 - ITA	Ed 2/20 apr 2022	

ULD positions in FORWARD COMPARTMENTS:

- **ULD based 88"x125"** (i.e. PAG, AAP, RAP)



- **ULD based 96"x125"** (i.e. PMC, AMP)



- **ULD based 60.4"x61.5"** (i.e. AKE)

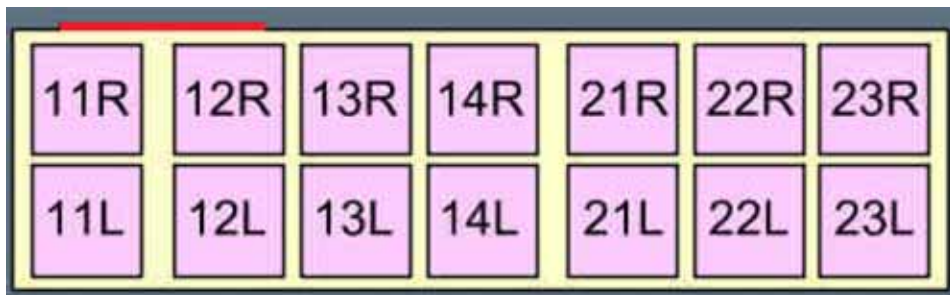

Pallet height must not exceed 162.5 cm (64 inches)

 Volume II HLM	INFORMATION PER AIRCRAFT TYPE	5.3	Page 3
	A330 202 - ITA	Ed 2/20 apr 2022	

ULD positions in AFT COMPARTMENTS:

- **ULD based 88"x125"** (i.e. PAG, AAP, RAP)



- **ULD based 96"x125"** (i.e. PMC, AMP)



- **ULD based 60.4"x61.5"** (i.e. AKE)

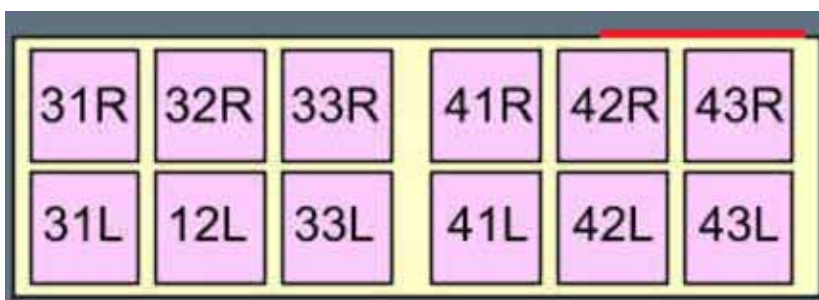

Pallet height must not exceed 162.5 cm (64 inches)

 Volume II HLM	INFORMATION PER AIRCRAFT TYPE	5.3	Page 4
	A330 202 - ITA	Ed 2/20 apr 2022	

Compartment 5 “Bulk” is reserved for bulk loads and is divided in 3 sections: 51, 52 and 53.

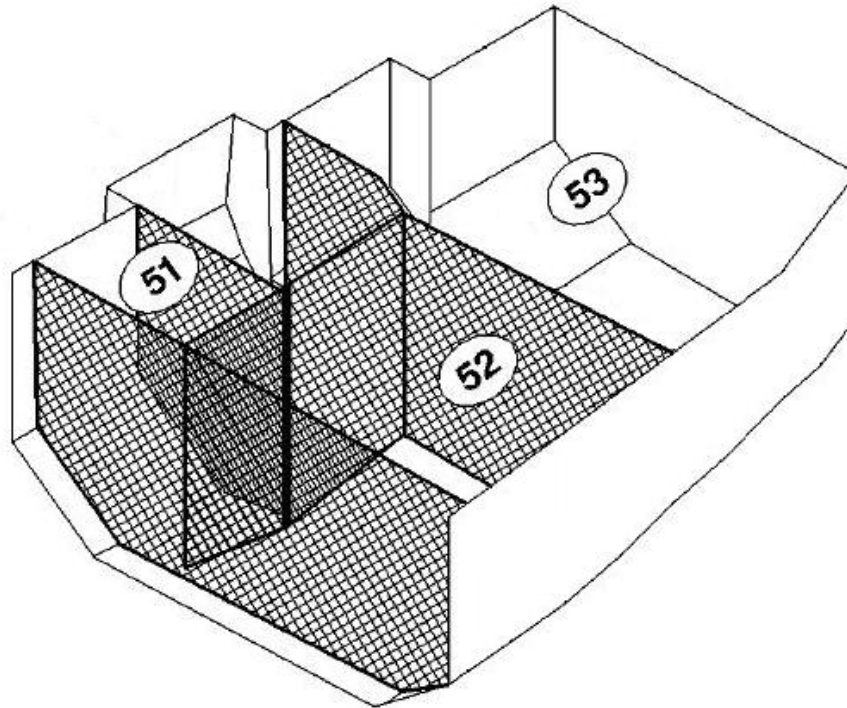

Forward and aft loading compartment configurations are flexible as they allow a **miscellaneous of pallet/containers based 88"/96"x125"** (PAG, PMC, RAP, AAP, AMP) and **AKE containers**, respecting the following conditions:

- Binding of ULD based 88"/96"x125" and AKE containers is single type, that is, each position (i.e. 11P, 21R, 32P, 33L, etc.) has its own locks.

Following table consider the constraint information above described and show the adopted loading configurations for the forward and aft compartments.

LOADING CONFIGURATION COMPARTMENTS 1 - 2 - 3 - 4																					
Reference number	LOADING POSITIONS																				
	COMPARTMENTS 1 - 2										COMPARTMENTS 3 - 4										
	ULD based 88"/96"x125"				AKE container						ULD based 88"/96"x125"				AKE container						
	12P	13P	21P	22P	11 L/R	12 L/R	13 L/R	14 L/R	21 L/R	22 L/R	23 L/R	31P	32P	41P	42P	31 L/R	32 L/R	33 L/R	41 L/R	42 L/R	43 L/R
000 A					X	X	X	X	X	X					X	X	X	X	X	X	X
010 A	X				X			X	X	X					X	X	X	X	X	X	X
011 A		X			X	X			X	X	X				X	X	X	X	X	X	X
012 A				X	X	X	X	X							X	X	X	X	X	X	X
013 A					X	X	X	X	X	X	X	X					X	X	X	X	X
020 A	X	X			X				X	X	X				X	X	X	X	X	X	X
021 A			X	X	X	X	X								X	X	X	X	X	X	X
022 A				X	X	X	X	X			X						X	X	X	X	X
023 A					X	X	X	X	X	X	X	X						X	X	X	X
030 A		X	X	X	X	X									X	X	X	X	X	X	X
031 A			X	X	X	X	X				X						X	X	X	X	X
032 A				X	X	X	X	X			X	X						X	X	X	X
033 A					X	X	X	X	X	X	X	X	X								X
040 A	X	X	X	X	X										X	X	X	X	X	X	X
041 A		X	X	X	X	X					X						X	X	X	X	X
042 A			X	X	X	X	X				X	X						X	X	X	X
043 A				X	X	X	X	X			X	X	X								X
044 A					X	X	X	X	X	X	X	X	X	X							
050 A	X	X	X	X	X						X						X	X	X	X	X
051 A		X	X	X	X	X					X	X						X	X	X	X
052 A			X	X	X	X	X				X	X	X								X
053 A				X	X	X	X	X			X	X	X	X							

LOADING CONFIGURATION COMPARTMENTS 1 - 2 - 3 - 4																				
Reference number	LOADING POSITIONS																			
	COMPARTMENTS 1 - 2											COMPARTMENTS 3 - 4								
	ULD based 88"/96"x125"				AKE container							ULD based 88"/96"x125"				AKE container				
	12P	13P	21P	22P	11 L/R	12 L/R	13 L/R	14 L/R	21 L/R	22 L/R	23 L/R	31P	32P	41P	42P	31 L/R	32 L/R	33 L/R	41 L/R	42 L/R
060 A	X	X	X	X	X						X	X						X	X	X
061 A		X	X	X	X	X					X	X	X							X
062 A			X	X	X	X	X				X	X	X	X						
070 A	X	X	X	X	X						X	X	X							X
071 A		X	X	X	X	X					X	X	X	X						
080 A	X	X	X	X	X						X	X	X	X						

LEGENDA

X - 1 ULD based 88"x125" or 96"x125"

X - 2 AKE

 Volume II HLM	INFORMATION PER AIRCRAFT TYPE	5.3	Page 7
	A330 202 - ITA	Ed 2 Rev 17/27 jan 26	



Due to fire extinguishing system feature, shipments containing Dangerous Goods (DG) as flammable and combustibles (class 2.1, 3 and 4) shall be loaded necessarily in the compartments 3 and 4. Segregation criteria shall be always respected (i.e. in case of DG class 2.1, 3 and 4, lithium-ion, lithium metal and sodium-ion batteries shall be loaded exclusively in the compartments 1-2).

COMPARTMENT	SURFACE RESISTANCE (Kg/m ²)	LINEAR RESISTANCE (Kg/m)	USABLE VOLUME (m ³)	MAX STRUCTURAL LOAD (Kg)	
1	659	2.070	31,6	13.378	18.869
2			23,0	10.204	
3			23,0	10.204	15.241
4			23,0	10.204	
51	732		19,7	339	3.468
52			1.413		
53			1.716		

Cargo holds are pressurized and have the following systems installed:

- smoke detection system,
- fire extinguishing system,
- ventilation system (compartments 1 - 2 - 5).

MAXIMUM ULD LOAD PER POSITION (Kg)		
ULD base dimensions (inches)		
88 x 125 (PAG-AAP-RAP)	96 x 125 (PMC-AMP)	60.4 x 61.5 (AKE)
4.626	5.102	1.587

 ITA AIRWAYS Volume II HLM	INFORMATION PER AIRCRAFT TYPE	5.3	Page 8
	A330 202 - ITA	Ed 2 Rev 5/02 nov 23	

5.3.1.2 Cargo compartment temperature and ventilation

The following table shows all necessary information for the transportation of goods that need specific temperature and ventilation on board this kind of aircraft.

HOLD	TEMPERATURE RANGE	VENTILATION	GROUND CONTROL	COCKPIT CONTROL
1 - 2	5°C - 25°C	YES	NO	YES
3 - 4		NO	NO	NO
5	5°C - 25°C	YES	NO	YES

Note: Damaged or missing separation net or cover will restrict the performance of compartment 5 ventilation system

5.3.1.3 Resistance of fittings

All compartments can host single tie-down fittings for the restraint of bulk loads. The following table shows the fittings minimum resistance in every direction.

COMPARTMENT	MINIMUM RESISTANCE
1 - 2 - 3 - 4 - 5	5000 LB / 2267 Kg

The resistance can be calculated by multiplying the fittings resistance by the coefficient related to the angle (9.3.3 LOAD RESTRAINT FACTORS) .

DIRECTION	COMPARTMENT	RESTRAINT FACTOR
FORWARD	ALL	1,5 G
BACKWARD	ALL	0,8 G
RIGHT - LEFT	1 - 2	0,89 G
	3 - 4	1,28 G
	5	1,55 G
UPWARD	1 - 2	1,5 G
	3 - 4	1,88 G
	5	2,24 G

 Volume II HLM	INFORMATION PER AIRCRAFT TYPE	5.3	Page 9
	A330 202 - ITA	Ed 2/20 apr 2022	

5.3.1.4 Forward hold (compartment 1-2) cargo door maximum dimensions

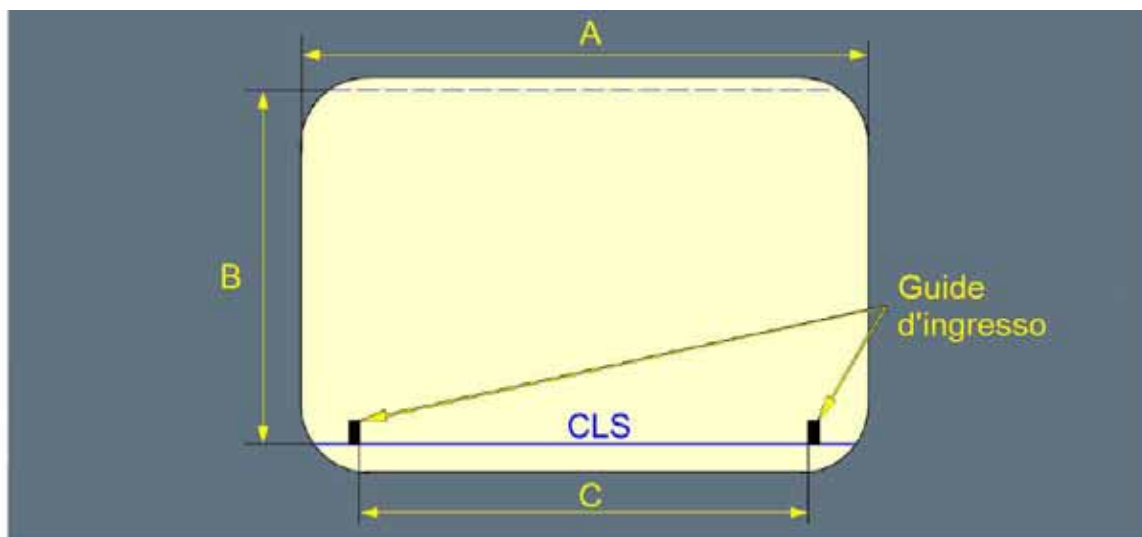

Legenda		Dimensioni	
		(m)	(in)
A	Larghezza dell'apertura libera	2.701	106.34
B	Altezza dell'apertura libera	1.699	66.89
C	Larghezza della porta a livello CLS	2.446	96.30

5.3.1.5 Aft hold (compartment 3-4) cargo door maximum dimensions

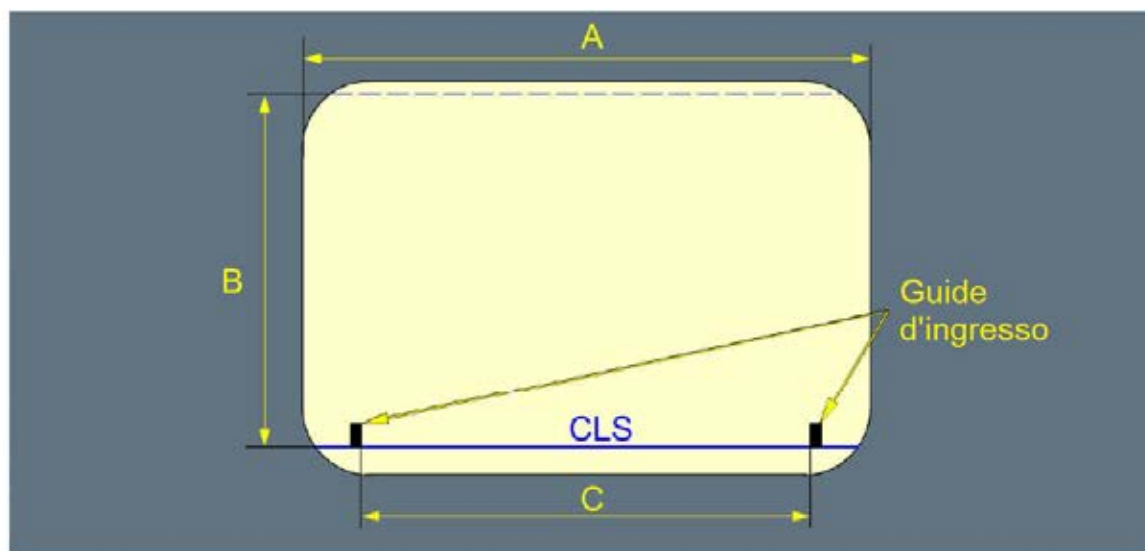

Legenda		Dimensioni	
		(m)	(In)
A	Larghezza dell'apertura libera	2.721	107.13
B	Altezza dell'apertura libera	1.682	66.22
C	Larghezza della porta a livello CLS	2.446	96.30

5.3.1.6 Bulk hold (compartment 5) cargo door maximum dimensions

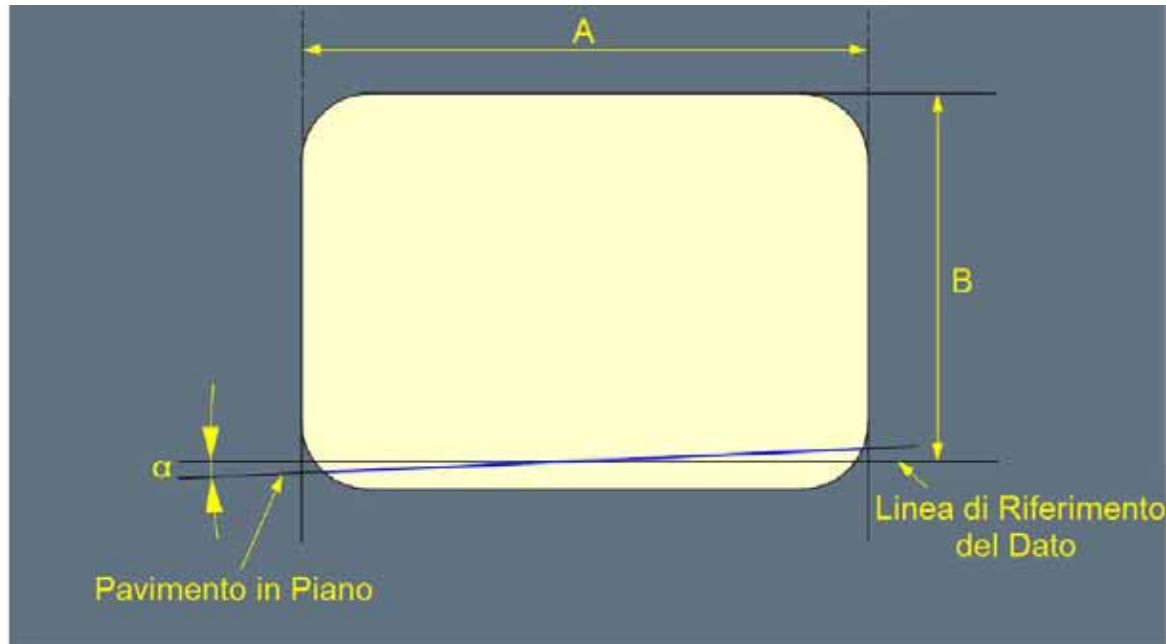

Legenda		Dimensioni		
		(m)	(in)	(Grado)
A	Larghezza dell'apertura libera	0.950	37.40	-
B	Altezza dell'apertura libera	0.637	25.08	-
α	Angolo tra pavimento in piano e la linea di riferimento del piano	-	-	1.20

5.3.1.7 Maximum dimensions for conventional load in compartment 5

The maximum dimensions of cargo packages which will pass through the bulk cargo door (compartment 5) are shown in the following tables:

- A. **Table 1 - for upright loading**
- B. **Table 2 - for upright and for tilted loading**

These dimensions are approximate values and refer to rectangular packages.

 Volume II HLM	INFORMATION PER AIRCRAFT TYPE	5.3	Page 12
	A330 202 - ITA	Ed 2/20 apr 2022	

5.3.1.7.1 A) Upright loading

Upright loading applies to heavy packages, which only can be loaded with the assistance of mechanical ground support equipment and in a position parallel to the bulk compartment floor.

Table 1

HEIGHT (cm)	Section 51, 52, 53	10 - 56					
WIDTH (cm)	Section 51, 52, 53	10	25	40	55	70	85
LENGTH (cm)	Section 51	<i>trial loading recommended</i>					
	Section 52	240	225	210	200	180	180
	Section 53	250	235	225	210	210	210

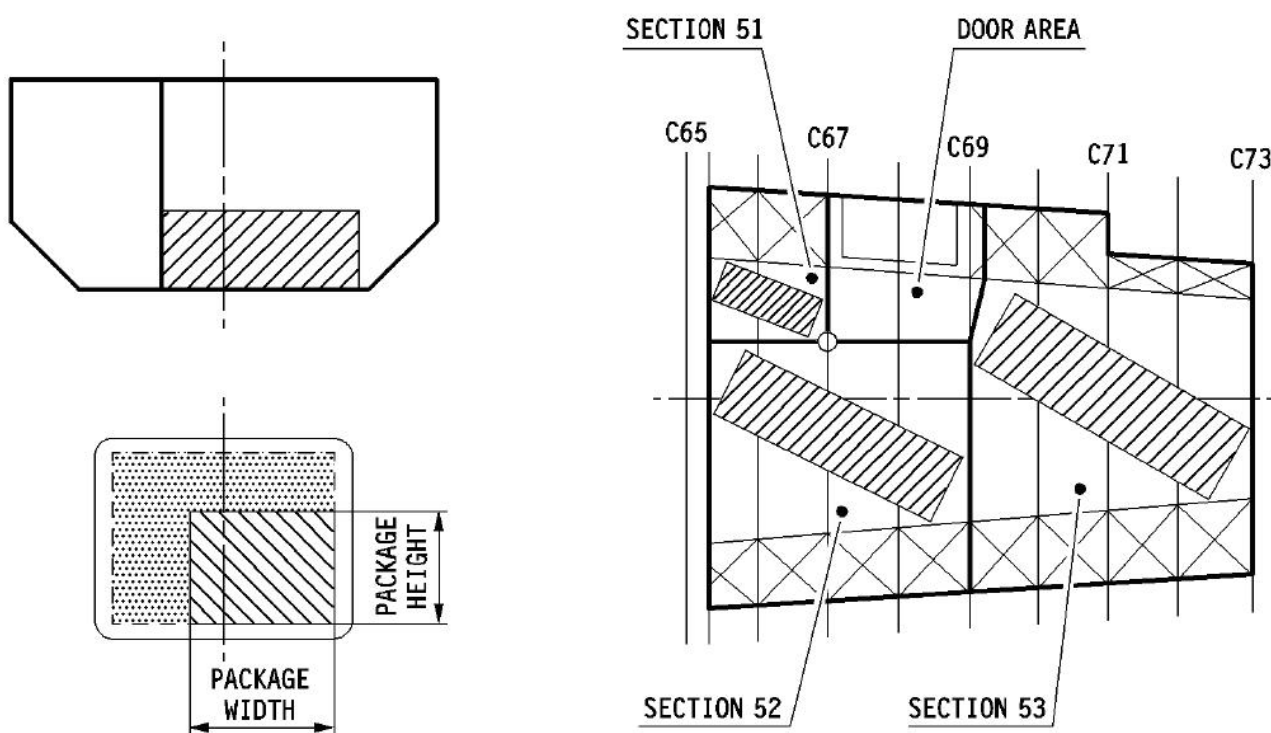

5.3.1.7.2 B) Upright loading and tilted loading

Upright loading and tilted loading applies to low density packages (weighing less than 150 Kg), which can be manoeuvred by hand. For loading the packages with maximum dimensions shown in table 2 it is not necessary to tilt the packages, but they must be lifted on the sloping part of the floor (provided that the package does not have a rigid structure).

Table 2

HEIGHT (cm)	Section 51, 52, 53	10 - 56							< 10
WIDTH (cm)	Section 51, 52, 53	10	25	40	55	70	85	100	
LENGTH (cm)	Section 51	<i>trial loading recommended</i>							
	Section 51	280	270	250	250	225	225	225	
	Section 51	290	280	270	260	250	250	250	

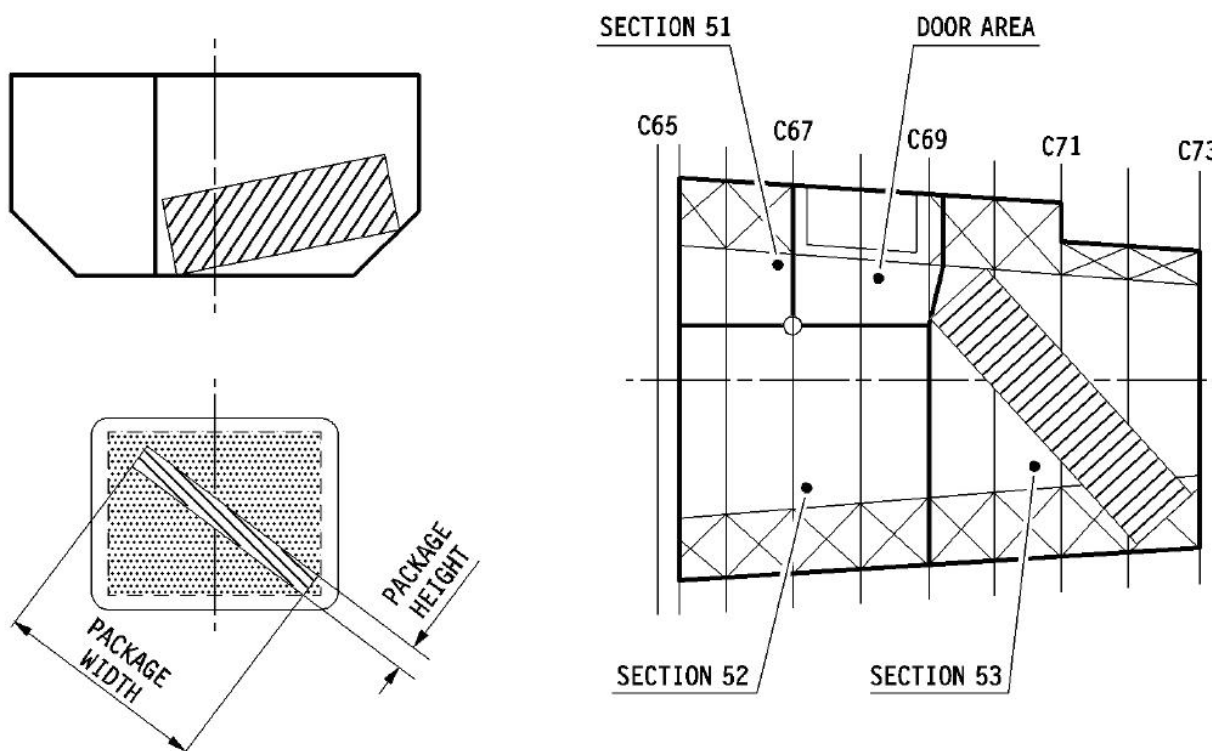

 Volume II HLM	INFORMATION PER AIRCRAFT TYPE	5.3	Page 14
	A330 202 - ITA	Ed 2/20 apr 2022	

5.3.1.8 Cross section of compartments 1-2-3-4 - internal dimensions for the loading of conventional loads

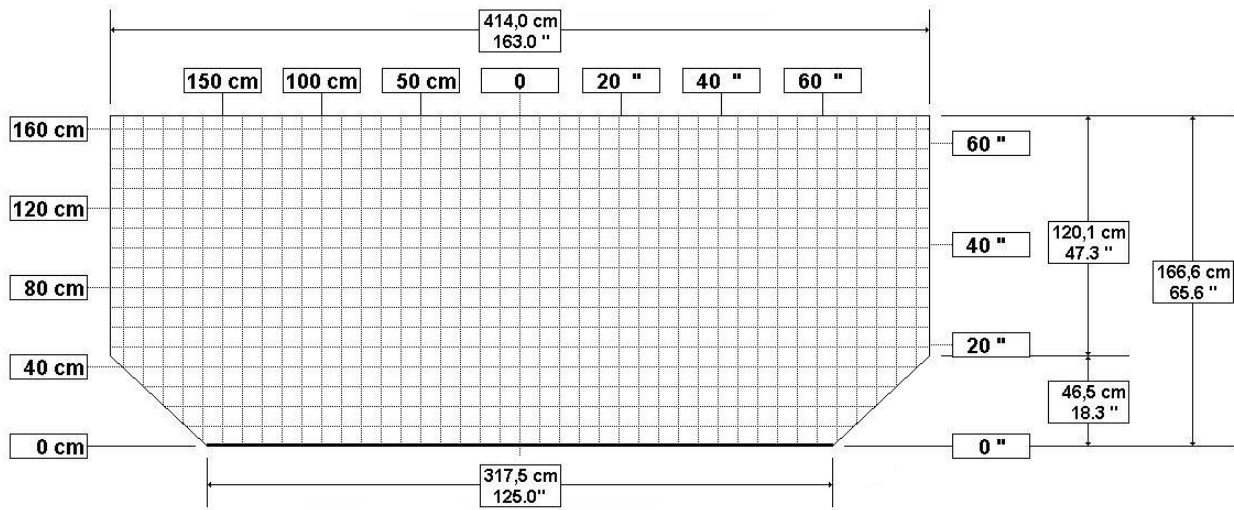

Notes:

- the side of each square is 10 cm (4,0") long,
- those given are the maximum dimensions: pallets must be built up in such a way as to keep the 5 cm / 2" minimum clearance from ceiling lights, smoke detectors and compartment contour,
- the pallet is about 2,5 cm (1") thick, and should be subtracted from the available height.

Overhangs on short sides of pallet based 88"/96"x125" are allowed

Overhangs on long side (125") of pallet based 88"x125" are allowed up to 8" (20 cm) provided that the overhang is not positioned next front / rear bulkheads and that a related obliged clearance is built in the adjoining pallet, if necessary

Overhangs on long side (125") of pallet based 96"x125" are not allowed

 ITA AIRWAYS Volume II HLM	INFORMATION PER AIRCRAFT TYPE		5.3	Page 15
	A330 202 - ITA		Ed 2/20 apr 2022	

5.3.2 FUEL

The fuel is contained in six tanks, two in each cantilever wing box, one in the wing box center section and one in the horizontal tail plane.

Layout and identification of these tanks are shown in the illustration below.

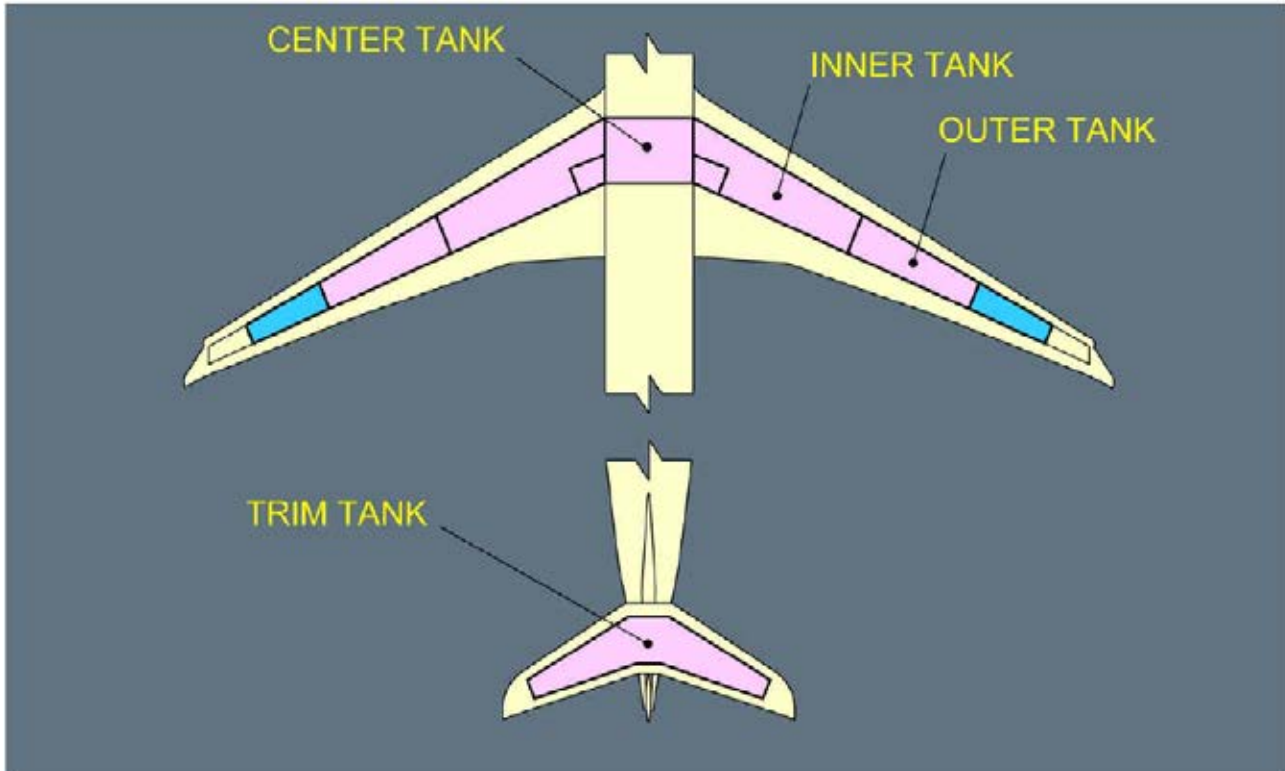



	A330-200 FUEL TANKS CAPACITY						
	Outer Tank Left	Inner Tank Left	Center Tank	Inner Tank Right	Outer Tank Right	Trim Tank	TOTAL
CAPACITY (Lt.)	3.650	42.000	41.560	42.000	3.650	6.230	139.090
WEIGHT (Kg)	2.865	32.970	32.625	32.970	2.865	4.890	109.185

If, for technical reasons, the fuel distribution in A330 aircraft tanks differs from the standard, the procedure "A330 non-standard fuel distribution" (4.3.3.4) must be applied.

 Volume II HLM	INFORMATION PER AIRCRAFT TYPE	5.3	Page 16
	A330 202 - ITA	Ed 2/20 apr 2022	

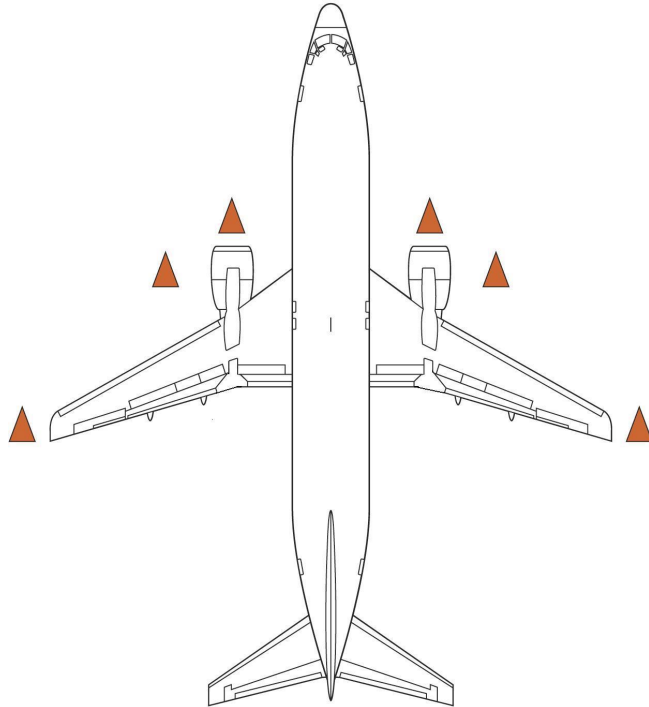
5.3.3 USE OF MARKER CONES



 Volume II HLM	INFORMATION PER AIRCRAFT TYPE	5.3	Page 17
	A330 202 - ITA	Ed 2/20 apr 2022	

5.3.4 CHOCKING OF AIRCRAFT

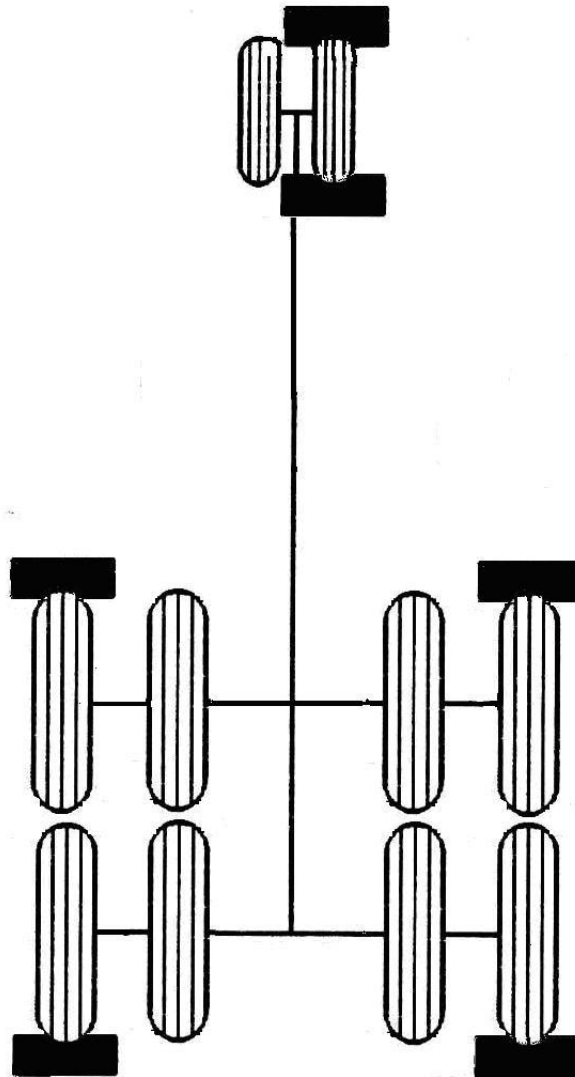

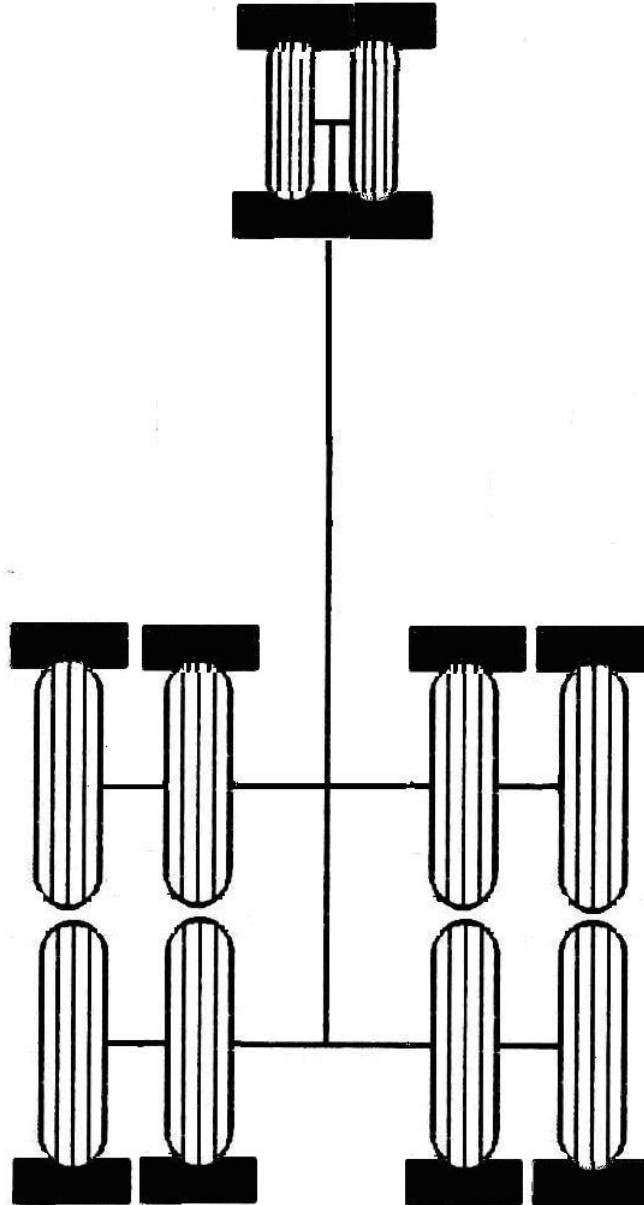

 Volume II HLM	INFORMATION PER AIRCRAFT TYPE	5.3	Page 18
	A330 202 - ITA	Ed 2/20 apr 2022	

5.3.5 Chocking of aircraft with wind over 25kt (46.3 km/h)

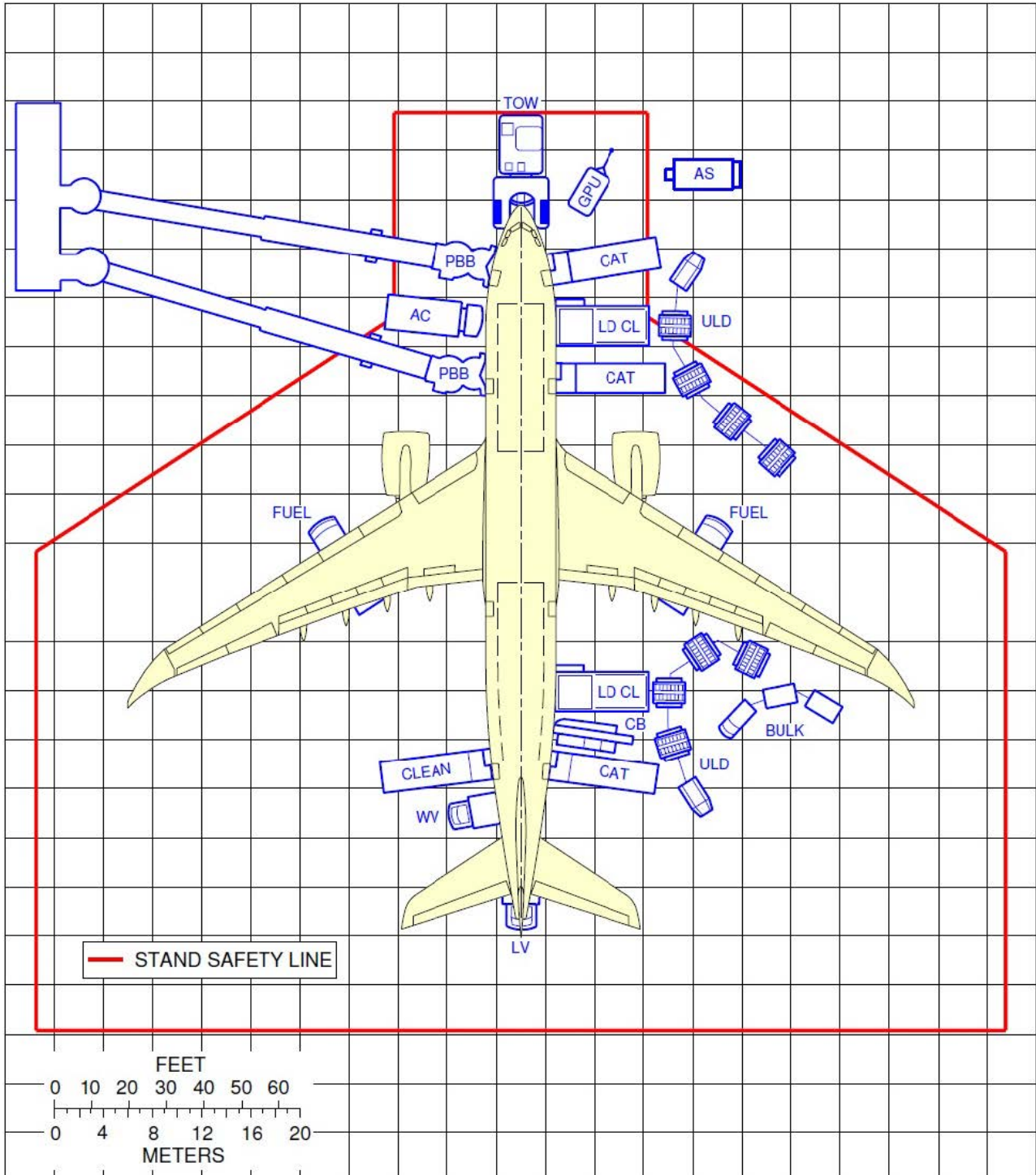

5.3.6 SERVICING ARRANGMENTS



 Volume II HLM	INFORMATION PER AIRCRAFT TYPE	5.3	Page 20
	A330 202 - ITA	Ed 2/20 apr 2022	

5.3.7 TOILETTE DRAIN

Below, the description of operational procedures for draining, flushing and filling of the chemical precharge.

1. Open service panel access door.
2. Unlock drain right valve using unlock lever.
3. Connect the waste drain hose coupling to panel drain nipple and assure that the hose is well connected.
4. Turn the left drain handle to unlock and pull until is fully extended.
5. While the tanks drain, feel the drain hose and make sure that all waste is draining out.

Note: If the draining is not performed correctly, inform a Company representative.

6. Turn the right drain handle to unlock and pull until is fully extended.
7. While the tanks drain, feel the drain hose and make sure that all waste is draining out.

Note: If the draining is not performed correctly, inform a Company representative.

8. Connect water supply hose coupling to the left flush nipple.
9. Flush the tank using 100 litres of chemical precharge, the pressure must not exceed 35 PSI.
10. Repeat the operation with the right flush nipple.
11. Close both drain handles valve.
12. Remove the waste drain hose coupling to panel drain nipple and leave the fitting cap opened.
13. Fill 18 litres of disinfectant precharge solution in the right tank, repeat the operation for the left tank.

Note: In case of leakage of chemical precharge from drain valves, inform a Company representative.

14. Closed the valves drain cap and latch the service panel.

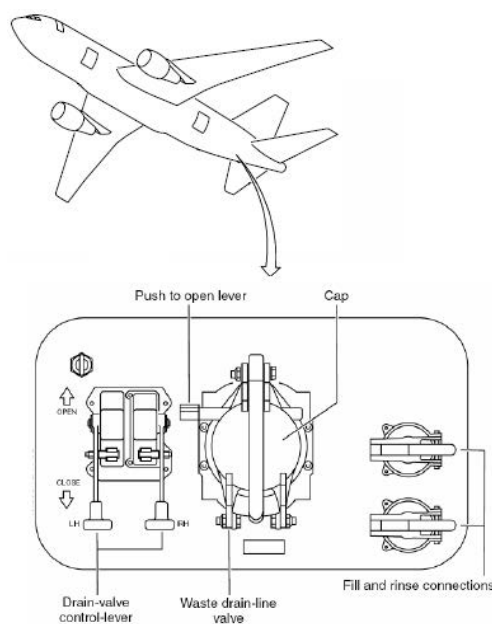

 Volume II HLM	INFORMATION PER AIRCRAFT TYPE	5.3	Page 21
	A330 202 - ITA	Ed 2/20 apr 2022	

5.3.8 FILLING POTABLE WATER

Potable water service shall always be performed in automatic mode (electrically powered aircraft). If for technical reasons is not possible to operate in automatic mode use manual mode. Adopting this procedure the tanks will be filled to FULL; in this case is mandatory to inform the Flight Deck that the water quantity is up to full.

Below, the description of operational procedures for filling potable water.

AUTOMATIC (electrically powered aircraft).

1. Open the service panel access door.
2. Remove fill nipple cap.
3. Connect fill service hose.
4. Turn the handle for the fill valve "*Fill Handle Valve*" to PULL TO FILL position and pull.

5. Select the water quantity foreseen for type of flight (75% is the standard quantity already included in the adjustment values) on "*Pre-Selector Switch*". Fill the tanks, the water pressure must not exceed 125 PSI. Once the water quantity matches the selected quantity the handle automatically returns on NORMAL position.

6. Close water supply valve and remove the service hose.
7. Check that there's no leakage of water from the fill valve.

Note: In case of leakage inform a Company representative.

8. Install cap on fill nipple.
9. Close and latch the service panel.

MANUAL

1. Open the service panel access door.
2. Remove fill nipple cap.
3. Connect fill service hose.
4. Turn the handle for the fill valve "*Fill Handle Valve*" to PULL TO FILL position and pull.
5. Open potable water source valve, the water pressure must not exceed 125 PSI.
6. Stop the procedure to fill the water tanks when water flows from the "*Overflow Port*". Turn the handle manually on NORMAL position.
7. Remove the service hose.
8. Check that there's no leakage of water from the fill valve.

Note: In case of leakage inform a Company representative.

9. Install cap on fill nipple.
10. Close and latch the service panel.

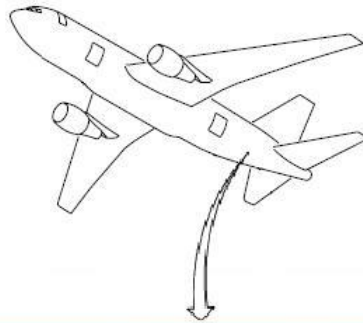

POTABLE WATER SERVICE PANEL	
I-EJGA/I-EJGB/EI-DIP/EI-DIR AIRCRAFT ONLY	ALL OTHER A330 AIRCRAFT
<p style="text-align: center;">WATER QUANTITY INDICATOR</p> <p>CONTROL LIGHTS:</p> <ul style="list-style-type: none"> FWD TANK FULL AFT TANK FULL FWD DRAIN VALVE OPEN FWD FILL/DRAIN VALVE OPEN FILL-LINE DRAIN VALVE OPEN ATTENTION -STOP-FILLING <p style="text-align: right;">OVERFLOW FITTING</p> <p style="text-align: right;">FILL/DRAIN FITTING</p> <p style="text-align: center;">FILL/DRAIN VALVE CONTROL HANDLE</p>	<p style="text-align: center;">WATER QUANTITY INDICATOR</p> <p>CONTROL LIGHTS:</p> <ul style="list-style-type: none"> TANK VENT OPEN FWD FILL/DRAIN VALVE OPEN FILL-LINE DRAIN VALVE OPEN TANK FULL <p style="text-align: right;">FILL/DRAIN FITTING</p> <p style="text-align: center;">WATER QUANTITY PRE-SELECTION SWITCH</p> <p style="text-align: center;">FILL/DRAIN VALVE CONTROL HANDLE</p>
WATER QUANTITY INDICATOR	
I-EJGA/I-EJGB/EI-DIP/EI-DIR AIRCRAFT ONLY	ALL OTHER A330 AIRCRAFT

5.3.9 SAFETY AREAS

5.3.9.1 Idle thrust - Intake and Blast areas

The Intake and Blast areas at Idle thrust of the aircraft must be observed and no personnel and equipment must stay within these areas when the engines are operating.

The Blast areas refer to the area behind the aircraft, starting from the aft end of operating engines. The safety distances shown in the table below must be observed.

IDLE THRUST (length of danger areas)		
- A - INTAKE AREA	- B - BLAST AREA	- C -
7.6 m	55.0 m	1.2 m

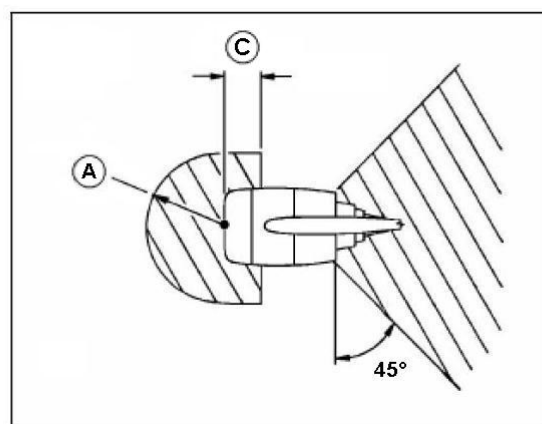
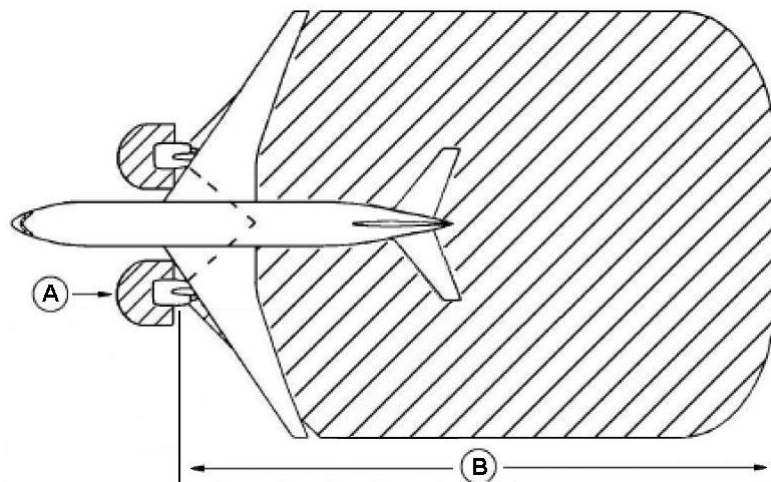

5.3.10 Steering limits

steering angle	R1 right main landing gear (RMLG)	R2 left main landing gear(LMLG)	R3 nose landing gear (NLG)	R4 wing	R5 nose	R6 tail
20	59.3 m	70 m	68 m	94.4 m	69.9 m	79.1 m
25	45.7 m	56.4 m	55.3 m	80.9 m	57.8 m	66.6 m
30	36.3 m	47 m	46.8 m	71.6 m	49.9 m	58.4 m
35	29.4 m	40.1 m	40.9 m	64.7 m	44.4 m	52.5 m
40	24 m	34.7 m	36.5 m	59.4 m	40.5 m	48.2 m
45	19.8 m	30.5 m	33.2 m	55.3 m	37.7 m	45 m
50	16.4 m	27.1 m	30.8 m	51.9 m	35.5 m	42.4 m
55	13.5 m	24.1 m	28.8 m	49.1 m	33.9 m	40.4 m
60	11.1 m	21.8 m	27.4 m	46.8 m	32.7 m	38.8 m
65	8.6 m	19.3 m	26 m	44.4 m	31.6 m	37.2 m
72 (MAX)	7.4 m	18.1 m	25.4 m	43.2 m	31.2 m	36.5 m

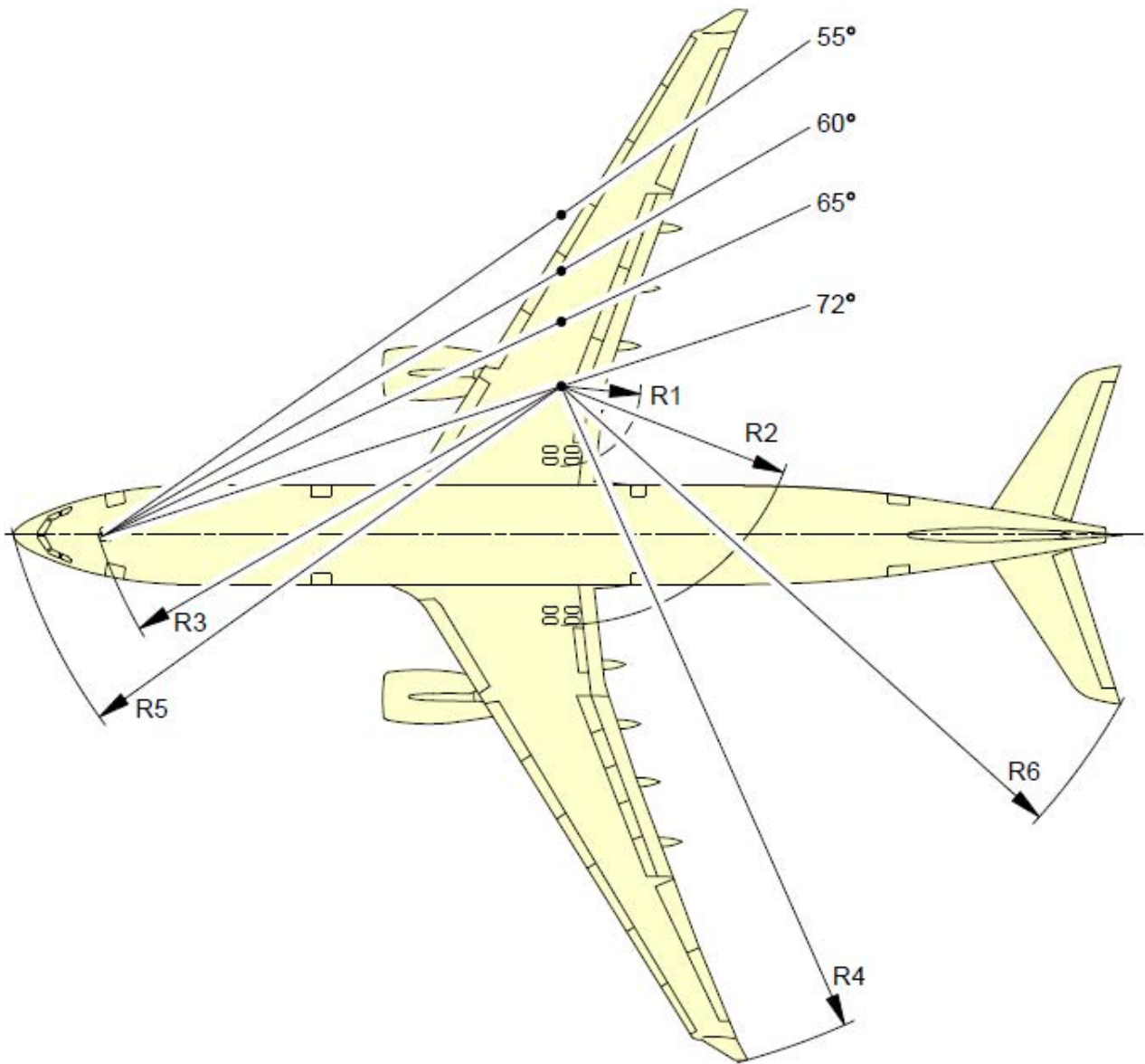

 Volume II HLM	INFORMATION PER AIRCRAFT TYPE	5.4	Page 1
	A321 neo - ITA	Ed 2 Rev 15/07 aug 25	

5.4 A321 neo - ITA

5.4.1 HOLDS

5.4.1.1 Cargo compartments specifications A321/neo

SPECIFICHE COMPARTIMENTI CARGO A321 neo	
CAPACITA' MASSIMA BAGAGLI/MERCI	Kg 12.837
VOLUME MASSIMO BAGAGLI/MERCI	m ³ 45,6
BAGAGLIAI ANTERIORI 1-2	5 CONTENITORI AKH oppure 5 PALLET PKC in qualsiasi INTERMIX
BAGAGLIAI POSTERIORI 3-4	5 CONTENITORI AKH oppure 5 PALLET PKC in qualsiasi INTERMIX
BAGAGLIAIO 5	Kg 800 Volume m ³ 5,9 CARICO SFUSO

Compartments **1-2-3-4** are equipped to load **AKH** containers (whose capacity can reach up to 25 bags each approx.) or **PKC** pallets (specific for live animals or for coffins with human remains or generally speaking for those conventional shipments which are not compatible with an AKH container).

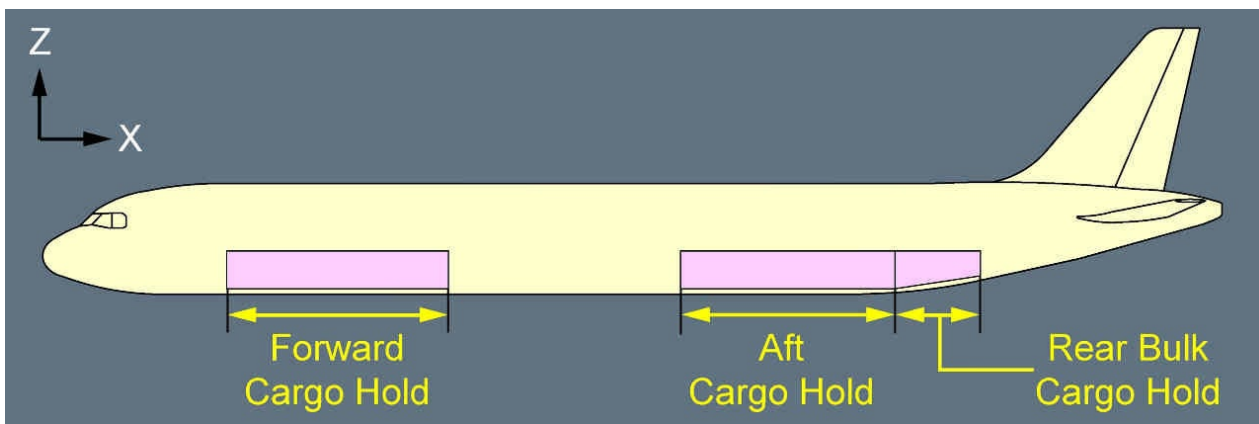

 Volume II HLM	INFORMATION PER AIRCRAFT TYPE	5.4	Page 2
	A321 neo - ITA	Ed 2 Rev 6/15 nov 23	

The forward hold is divided in two compartments: **1** which positions are identified as 11 and 12; **2** which positions are identified as 21, 22 and 23.

The aft hold is also divided in two compartments: **3** which positions are identified as 31, 32 and 33; **4** which positions are identified as 41 and 42.

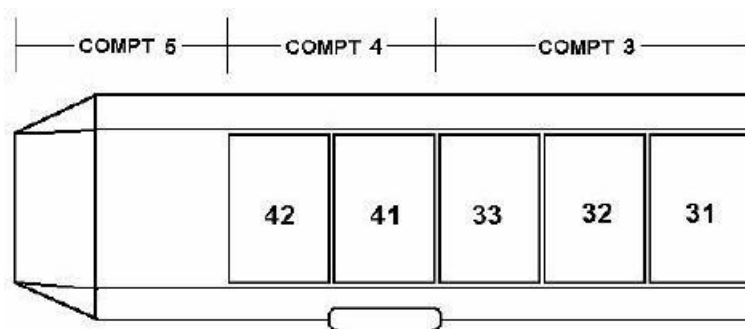

Each lock shall be always armed on empty ULD position (even if the hold is completely empty). The following table shows the suggested loading sequence of ULD in each hold.

LOADING SEQUENCE OF ULDS											
	Forward Hold Positions						Aft Hold Positions				
	11	12	21	22	23		31	32	33	41	42
1 ULD	x					1 ULD				x	
2 ULD	x	x				2 ULD			x	x	
3 ULD	x	x	x			2 ULD			x	x	
4 ULD	x	x	x	x		3 ULD		x	x	x	
5 ULD	x	x	x	x	x	3 ULD			x	x	
						4 ULD	x	x	x	x	
						4 ULD		x	x	x	
						5 ULD	x	x	x	x	

 Volume II HLM	INFORMATION PER AIRCRAFT TYPE	5.4	Page 3
	A321 neo - ITA	Ed 2 Rev 15/07 aug 25	

Intermix between forward and aft holds options is allowed.

For example, in case of loading of 2 ULDs on an aircraft, the possible configurations are:

- a. 2 ULDs on forward hold (positions 11 -12),
- b. 1 ULD on forward hold + 1 ULD on aft hold (positions 11 - 41),
- c. 2 ULDs on aft hold (positions 32 - 41 or 41 - 42).



Attention:

In the case of inoperative positions in the FWD and AFT compartments, the LC is allowed to plan the load in the remaining operational positions, while still guaranteeing the loading sequence with the exclusion of the inoperative position

Compartment 5 “bulk” is dedicate to loose shipments. For aircraft without door for such compartment, loading is performed via compartment 4, specifically from position 42: they are separated by a net which has to be correctly **installed and operative**, otherwise compartment 5 cannot be used unless **all loads are individually tied down on the floor**.

COMPARTMENT	SURFACE RESISTANCE (Kg/m ²)	USABLE VOLUME (m ³)	MAX STRUCRAL LOAD (Kg)
1	488	7,36	2.268
2		11,04	3.402
3		11,04	3.402
4		7,36	2.268
5	732	5,88	800

Note: Maximum structural loads include the ULD tare weight.

Compartments **1-2-3-4** are equipped with a Cargo Loading System for the loading/unloading of ULDs.

Cargo holds are pressurized and have the following systems installed:

- smoke detection system,
- fire extinguishing system,
- ventilation system (compartments 1 - 2)

MAXIMUM ULD LOAD PER POSITION (Kg)
ULD base dimensions (inches)
60.4 x 61.5 (AKH-PKC)
1.134

 ITA AIRWAYS Volume II HLM	INFORMATION PER AIRCRAFT TYPE	5.4	Page 4
	A321 neo - ITA	Ed 2 Rev 17/27 jan 26	

5.4.1.2 Cargo compartment temperature and ventilation

The following table shows all necessary information for the transportation of goods that need specific temperature and ventilation on board this kind of aircraft.

COMPART-MENT	TEMPERATURE RANGE	VENTILATION	GROUND CONTROL	COCKPIT CONTROL
1 - 2	5°C - 26°C	SI	NO	SI
3 - 4	2°C - 4°C	NO	NO	NO
5	2°C - 4°C	NO	NO	NO



Due to fire extinguishing system feature, shipments containing Dangerous Goods (DG) as flammable and combustibles (class 2.1, 3 and 4) shall be loaded necessarily in the compartments 3 and 4 or 5. Segregation criteria shall be always respected (i.e. in case of DG class 2.1, 3 and 4, lithium-ion, lithium metal and sodium-ion batteries shall be loaded exclusively in the compartments 1-2).

 ITA AIRWAYS Volume II HLM	INFORMATION PER AIRCRAFT TYPE	5.4	Page 5
	A321 neo - ITA	Ed 2 Rev 6/15 nov 23	

5.4.2 CLS malfunctions

forward hold

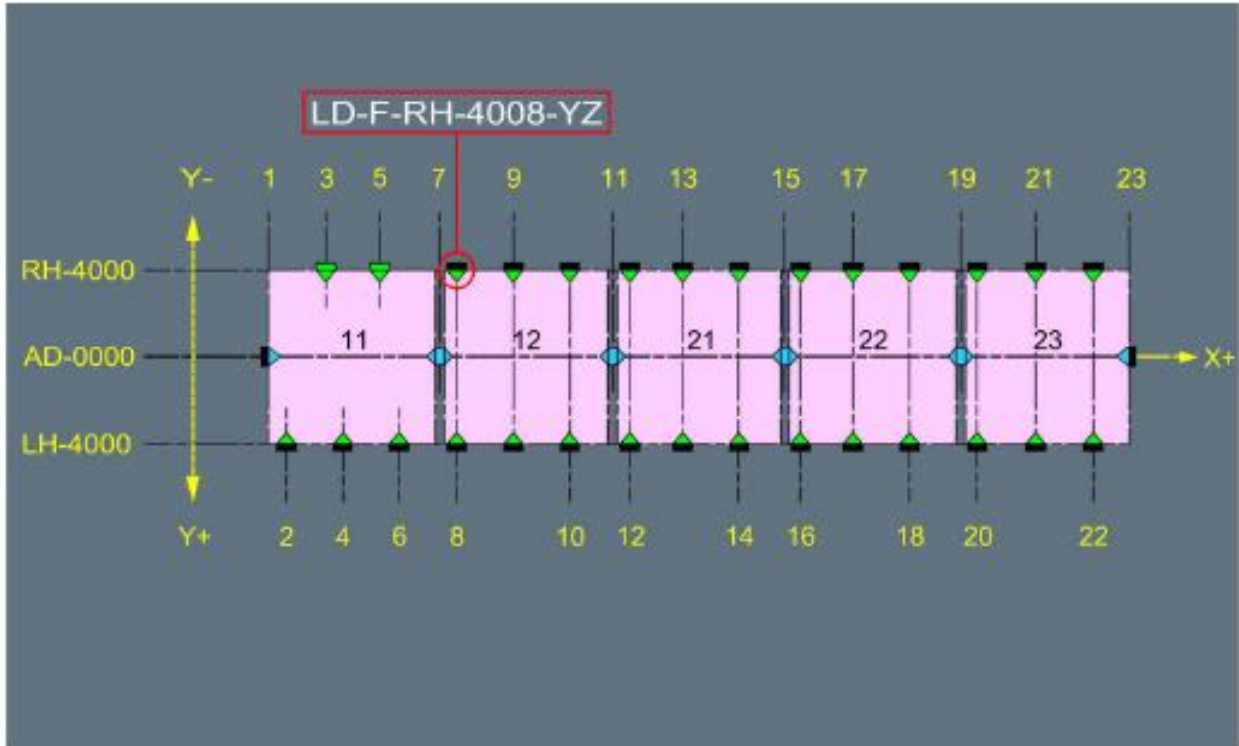

aft hold

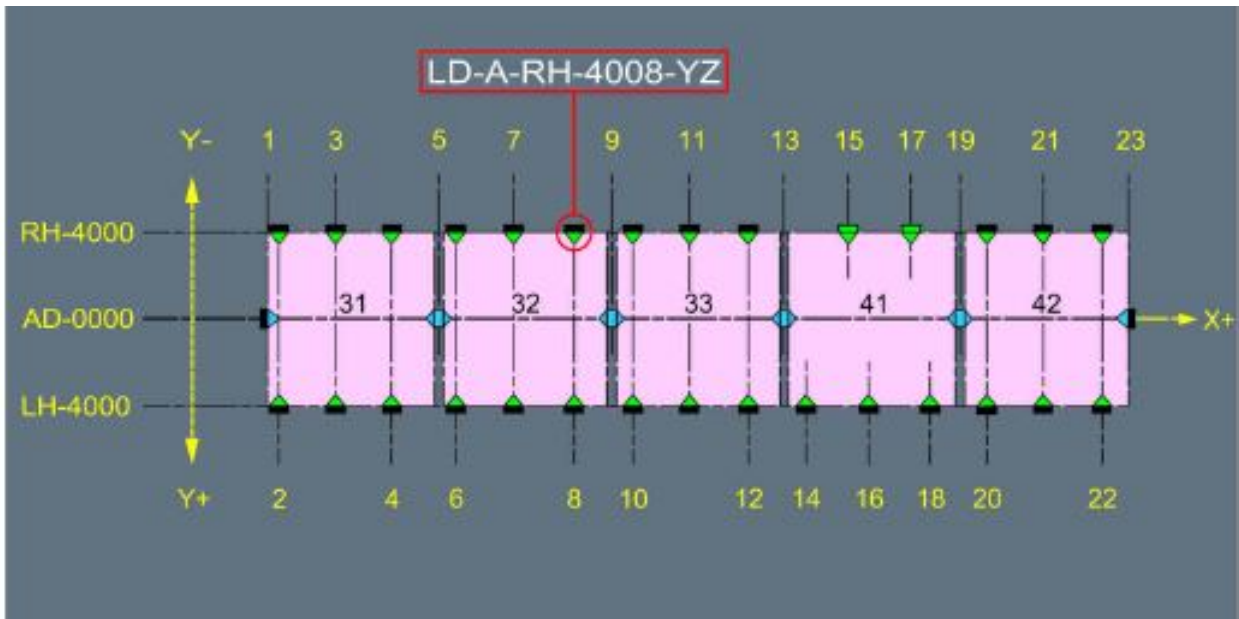

Latch type	position	latch code	failed latch per position	required conditions	
XZ - single latch	11, 12	LD-F-AD-0007-XZ	1 latch	ULD removed	
	12, 21	LD-F-AD-0011-XZ	1 latch	ULD removed	
	21, 22	LD-F-AD-0015-XZ	1 latch	ULD removed	
	22,23	LD-F-AD-0019-XZ	1 latch	ULD removed	
YZ - latch	11	LD-F-LH-4002-YZ	1 latch	empty ULD	
		LD-F-LH-4004-YZ LD-F-LH-4006-YZ	2 or more latch	ULD removed	
	12	LD-F-RH-4008-YZ LD-F-LH-4008-YZ	1 latch	empty ULD	
		LD-F-RH-4009-YZ LD-F-LH-4009-YZ LD-F-RH-4010-YZ LD-F-LH-4010-YZ	2 or more latch	ULD removed	
	21	LD-F-RH-4012-YZ LD-F-LH-4012-YZ	1 latch	empty ULD	
		LD-F-RH-4013-YZ LD-F-LH-4013-YZ LD-F-RH-4014-YZ LD-F-LH-4014-YZ	2 or more latch	ULD removed	
	22	LD-F-RH-4016-YZ LD-F-LH-4016-YZ	1 latch	empty ULD	
		LD-F-RH-4017-YZ LD-F-LH-4017-YZ LD-F-RH-4018-YZ LD-F-LH-4018-YZ	2 or more latch	ULD removed	
	23	LD-F-RH-4020-YZ LD-F-LH-4020-YZ	1 latch	empty ULD	
		LD-F-RH-4021-YZ LD-F-LH-4021-YZ LD-F-RH-4022-YZ LD-F-LH-4022-YZ	2 or more latch	ULD removed	
	YZ - latch (door sill)	11	LD-F-RH-4003-YZ LD-F-RH-4005-YZ	1 or more latch	ULD removed
	XZ - latch (end stop)	11	LD-F-AD-0001-XZ	1 latch	ULD removed
13		LD-F-AD-0023-XZ	1 latch	ULD removed	

 Volume II HLM	INFORMATION PER AIRCRAFT TYPE		5.4	Page 7
	A321 neo - ITA			Ed 2 Rev 6/15 nov 23

XZ - single latch	31, 32	LD-A-AD-0005-XZ	1 latch	ULD removed
	32, 33	LD-A-AD-0009-XZ	1 latch	ULD removed
	33, 41	LD-A-AD-0013-XZ	1 latch	ULD removed
	41,42	LD-A-AD-0019-XZ	1 latch	ULD removed
YZ - latch	31	LD-A-RH-4002-YZ	1 latch	empty ULD
		LD-A-LH-4002-YZ	2 or more latch	ULD removed
	LD-A-RH-4003-YZ	2 or more latch		
	LD-A-RH-4003-YZ		2 or more latch	ULD removed
	LD-A-RH-4004-YZ	2 or more latch		
	LD-A-LH-4004-YZ		2 or more latch	ULD removed
	32	LD-A-RH-4006-YZ		
		LD-A-LH-4006-YZ	2 or more latch	ULD removed
	LD-A-RH-4007-YZ	2 or more latch		
	LD-A-LH-4007-YZ		2 or more latch	ULD removed
	LD-A-RH-4008-YZ	2 or more latch		
	LD-A-LH-4008-YZ		2 or more latch	ULD removed
33	LD-A-RH-4010-YZ	1 latch		
	LD-A-LH-4010-YZ	2 or more latch	ULD removed	
LD-A-RH-4011-YZ	2 or more latch			ULD removed
LD-A-LH-4011-YZ		2 or more latch	ULD removed	
LD-A-RH-4012-YZ	2 or more latch			ULD removed
LD-A-LH-4012-YZ		2 or more latch	ULD removed	
41	LD-A-LH-4014-YZ			1 latch
	LD-A-LH-4016-YZ	2 or more latch	ULD removed	
LD-A-LH-4018-YZ	2 or more latch			ULD removed
42		LD-A-RH-4020-YZ	1 latch	
	LD-A-LH-4020-YZ	2 or more latch	ULD removed	
LD-A-RH-4021-YZ	2 or more latch			ULD removed
LD-A-LH-4021-YZ		2 or more latch	ULD removed	
LD-A-RH-4022-YZ	2 or more latch			ULD removed
LD-A-LH-4022-YZ		2 or more latch	ULD removed	
YZ- latch (door sill)	41			LD-A-RH-4015-YZ
		LD-A-RH-4017-YZ		
XZ- latch (end stop)	31	LD-A-AD-0001-XZ	1 latch	ULD removed
	42	LD-A-AD-0019-XZ	1 latch	ULD removed
For one applicable position, the failed latches are of different types				ULD removed

Legenda:

LD - Lower Deck

F - Forward Hold

A - Aft Hold

RH - Right hand Side

 Volume II HLM	INFORMATION PER AIRCRAFT TYPE	5.4	Page 8
	A321 neo - ITA	Ed 2 Rev 6/15 nov 23	

LH - Left hand Side

AD - Aircraft Datum

XZ - Restraint in X and Z directions

YZ - Restraint in Y and Z directions

5.4.2.1 Fwd and aft cargo doors dimensions

FRONT VIEW OF THE DOOR

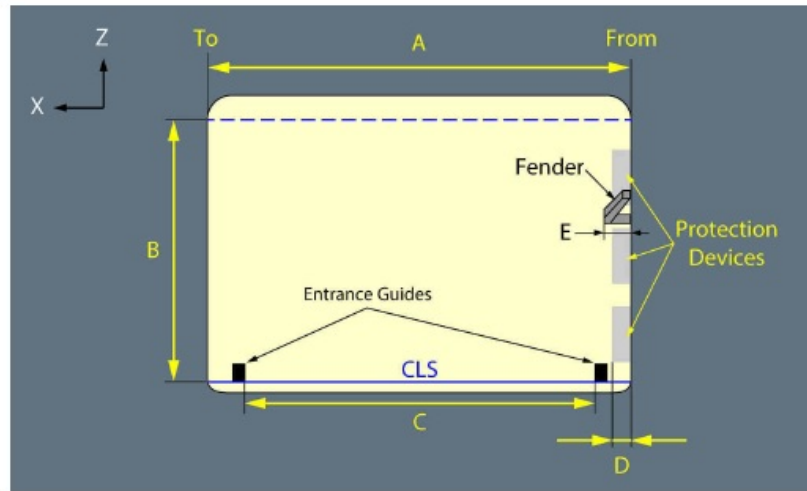

Legend		Dimensions	
		(m)	(in)
A	Clear opening width	1.817	71.54
B	Clear opening height	1.198	47.16
C	Door width at CLS level	1.541	60.67
D	Protection device thickness	0.067	2.64
E	Fender thickness	0.096	3.78

SIDE VIEW OF THE DOOR

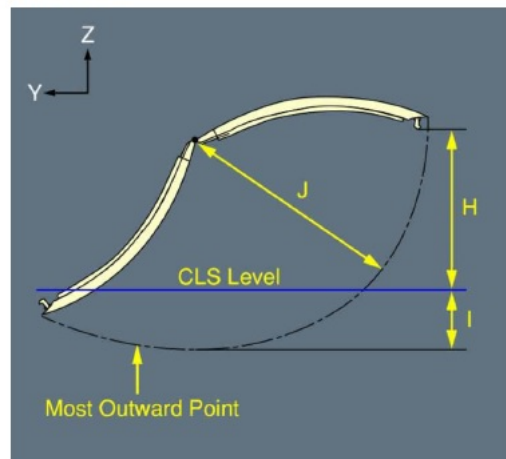

Legend		Dimensions	
		(m)	(in)
H	Clearance between the CLS level and the hooks (when the door is in fully opened position)	1.385	54.53
I	Clearance below the CLS level when the door is operated	0.687	27.05
J	Door opening radius	2.024	79.68

FRONT VIEW OF THE DOOR

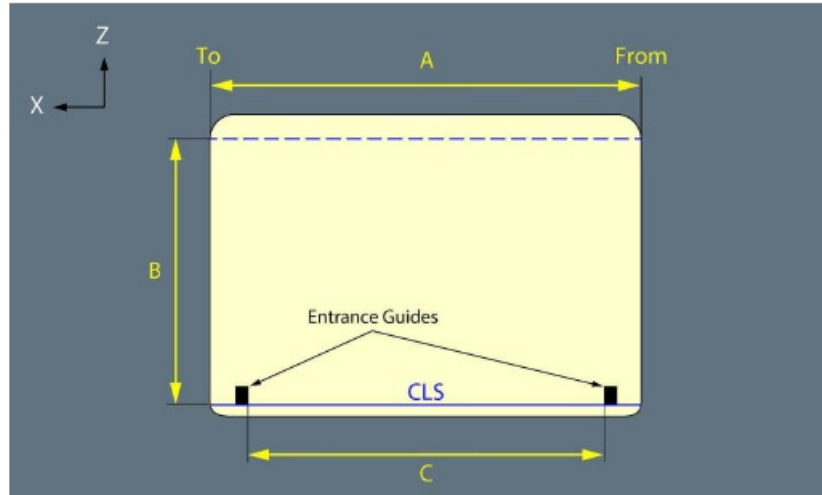

Legend		Dimensions	
		(m)	(in)
A	Clear opening width	1.817	71.54
B	Clear opening height	1.198	47.16
C	Door width at CLS level	1.541	60.67

SIDE VIEW OF THE DOOR

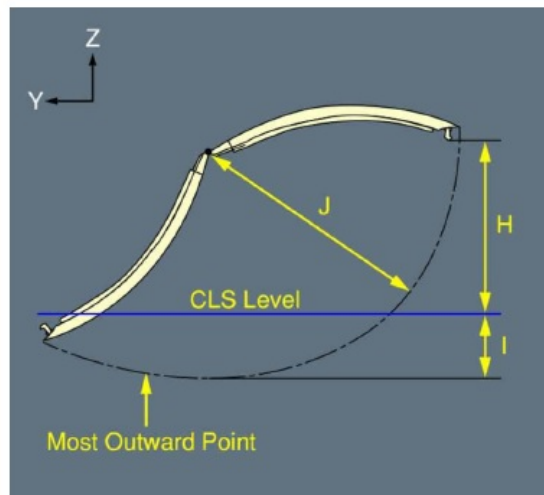

Legend		Dimensions	
		(m)	(in)
H	Clearance between the CLS level and the hooks (when the door is in fully opened position)	1.385	54.53
I	Clearance below the CLS level when the door is operated	0.687	27.05
J	Door opening radius	2.024	79.68

 Volume II HLM	INFORMATION PER AIRCRAFT TYPE	5.4	Page 11
	A321 neo - ITA	Ed 2 Rev 15/07 aug 25	

5.4.2.2 Loading through the cargo door of compartment 5

The size of the packages that can be loaded depends on:

- the dimensions of cargo hold 5 door
- the dimensions of the cargo hold 5

In the table below, the maximum dimensions refer to packages that can be loaded diagonally and with the aid of weight distribution spreaders.

Package Width (m)	Package Height	
	0.400 m	0.600 m
Maximum Package Length (m)		
0.000	2.155	1.989
0.100	2.100	1.815
0.200	2.053	1.613
0.300	1.957	1.409
0.400	1.757	1.203
0.500	1.556	0.991
0.600	1.355	-
0.700	1.154	-
0.800	0.959	-

5.4.2.3 Loading through compartment 4

The size of the packages that can be loaded depends on:

- the dimensions of cargo hold 5 door
- the dimensions of the cargo hold 5
- the lashing system of the cargo hold 5

Package Width (m)	Package Height				
	0.400 m	0.600 m	0.750 m	0.900 m	1.000 m
Maximum Package Length (m)					
0.000	2.664	2.601	2.585	2.050	1.031
0.100	2.618	2.574	2.497	2.031	0.975
0.200	2.580	2.557	2.384	2.017	0.965
0.300	2.552	2.381	2.269	1.715	0.965
0.400	2.533	2.219	2.149	1.715	-
0.500	2.443	1.965	1.907	1.715	-
0.600	2.313	-	-	-	-
0.700	2.177	-	-	-	-
0.800	2.031	-	-	-	-
0.900	1.809	-	-	-	-

Compartment 5 is not equipped with ventilation and temperature control systems

 Volume II HLM	INFORMATION PER AIRCRAFT TYPE	5.4	Page 12
	A321 neo - ITA	Ed 2 Rev 15/07 aug 25	

5.4.3 LOADING PROCEDURE FOR A321 NEO CONTAINERIZED A/C IN STATIONS WITHOUT SUITABLE LOADER

In order to guarantee the operations in stations without suitable loader to handle a A321 containerized, it is mandatory to follow some instructions on how to load/unload holds.

In station without suitable loader, AKH containers and PKC pallets shall not be offloaded. Baggage offloading will be done totally manually or with the support of a conveyor belt.

Loading of baggage in holds must be performed in order to not allow subsequent stations, during loading/offloading operations, to remove transit baggage.

From departing stations and/or transit stations a full fit configuration is required as follows:

- 3 AKH containers in 23, 31 and 42 positions.
- 7 PKC pallets with appropriate nets in 11, 12, 21, 22, 32, 33 and 41 positions.

All containers must be loaded with the opening facing the hold doors, in order to allow baggage handling in the hold.

Person in charge for planning and issuing the “loading instructions” and the loading Supervisor shall verify that what expected on board, in weight, dimensions and volume terms, is compatible with the current procedure and with the type of aircraft used. In case of irregularities, the Station Manager or its delegate shall be informed promptly.

Station Manager or its delegate shall verify that the current procedure is aligned with local regulation and legislation.

5.4.3.1 Cross section of compartments 1-2-3-4 - internal dimensions for the loading of conventional loads

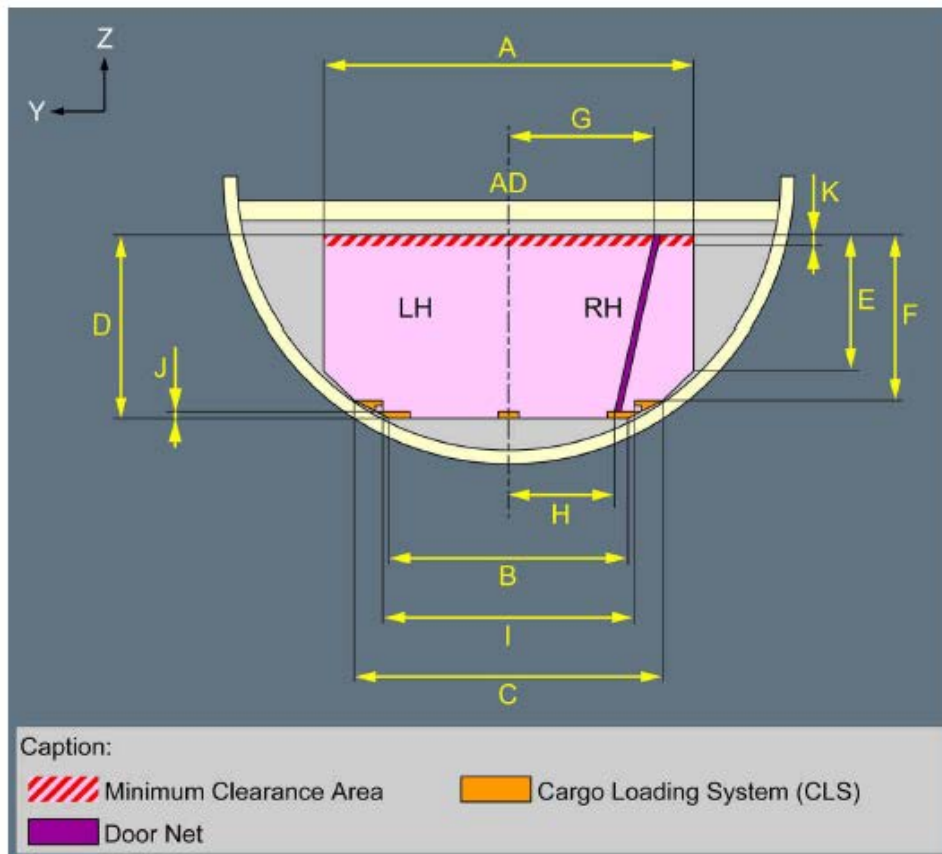

H-ARM (m)	Dimensions (m)										
	A	B	C	D	E	F	G	H	I	J	K
9.858	2.630	1.430	2.098	1.242	0.797	1.065	0.765	0.577	1.520	0.035	0.051
11.633	2.630	1.430	2.098	1.242	0.797	1.065	0.765	0.577	1.520	0.035	0.051
17.908	2.630	1.430	2.098	1.242	0.797	1.065	-	-	1.520	0.035	0.051

- Uld shall be built in such a way to keep the minimum distance of 5 cm/2" from the ceiling, from smoke detectors and from the compartment contour.
- pallet thickness is approximately 2,5 cm (1"), which must be subtracted from the available height.

The maximum height of the pallets must not exceed 114.3 cm/45"

Any overhang from the short side of the 60.4 "x61.5" pallet is permitted

Any overhang from the long side (61.5") of the 60.4 "x61.5" pallet is permitted up to 3.1" (8 cm) provided that the overhang is not allocated adjacent to the front/rear bulkheads of the hold and that a mandatory fold is provided in the adjacent pallet

 Volume II HLM	INFORMATION PER AIRCRAFT TYPE	5.4	Page 14
	A321 neo - ITA	Ed 2 Rev 6/15 nov 23	

5.4.4 Fuel

The A321-neo is equipped with three tanks: one centre tank and two wing tanks. The following table shows their capacity in kg. as to weight and in litres as to volume.

	WEIGHT Kg	VOLUME Lt
LEFT WING TANK	6036	7690
RIGHT WING TANK	6036	7690
CENTER TANK	6437	8200
TOTAL	18509	23580

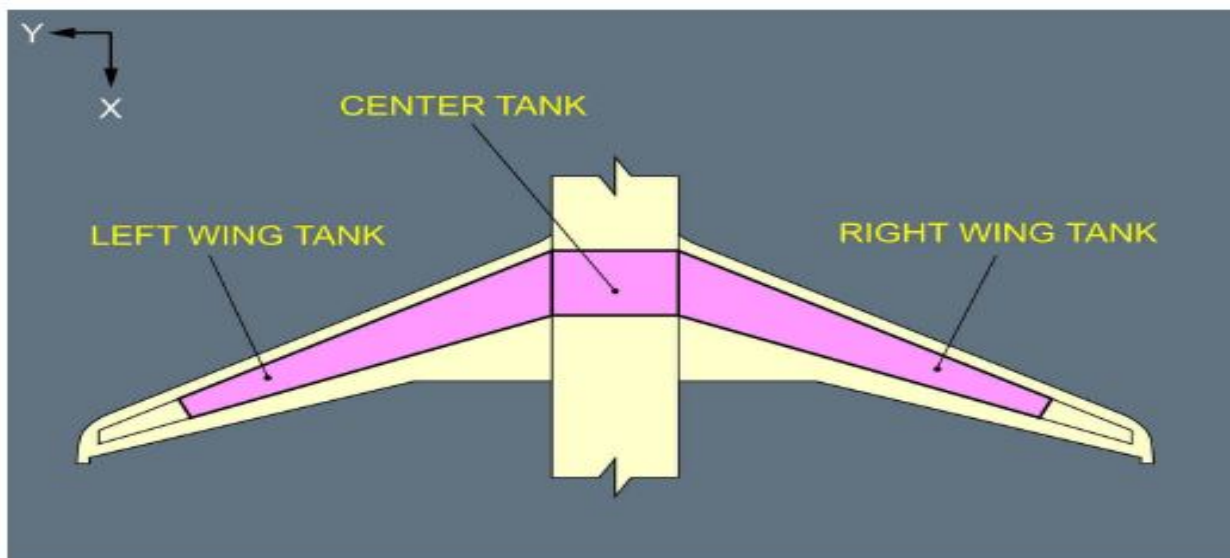

To determine the influence of fuel loading on the aircraft's centre of gravity, use the fuel pattern diagram on the back page of the balance chart form, as shown below:

Total fuel at density:	0,77 kg/l	0,785 kg/l	0,81 kg/l
Weight (kg)	ΔM.I.	ΔM.I.	ΔM.I.
0	0	0	0
500	0	0	0
1000	-1	-1	-1
1500	-1	-1	-1
2000	-1	-1	-1
2500	-1	-1	-1
3000	-2	-2	-2
3500	-2	-2	-2
4000	-2	-2	-2
4500	-2	-2	-2
5000	-2	-2	-3
5500	-3	-3	-3
6000	-3	-3	-3
6500	-3	-3	-3
7000	-3	-3	-3
7500	-3	-3	-3
8000	-3	-3	-3
8500	-3	-3	-3
9000	-3	-3	-3
9500	-3	-3	-3
10000	-2	-3	-3
10500	-2	-2	-3
11000	-2	-2	-2
11500	-1	-1	-2
12000	-1	-1	-1
12500	-1	-1	-1
13000	-1	-1	-1
13500	-2	-2	-1
14000	-2	-2	-2
14500	-3	-2	-2
15000	-3	-3	-3
15500	-3	-3	-3
16000	-4	-4	-3
16500	-4	-4	-4
17000	-5	-4	-4
17500	-5	-5	-5
18000	-5	-5	-5
18157	-6	-5	-5
18500		-6	-5
18510		-6	-5
19000			-6
19100			-6

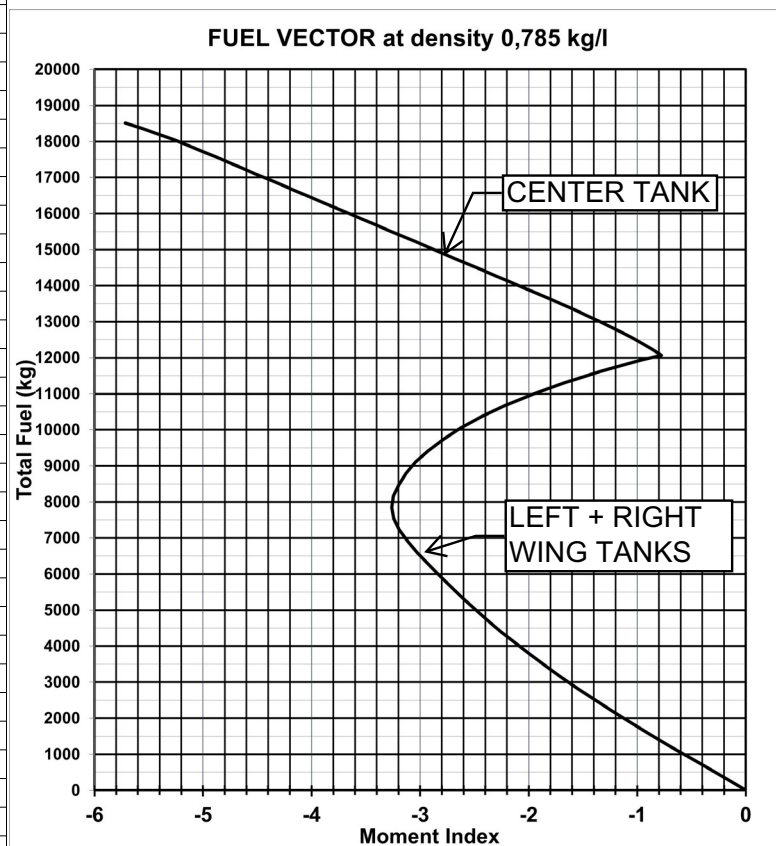

 Volume II HLM	INFORMATION PER AIRCRAFT TYPE	5.4	Page 16
	A321 neo - ITA	Ed 2 Rev 6/15 nov 23	

5.4.5 LOAD LIMITATIONS

5.4.5.1 Shear and bending moment limitations

Shear load and bending moment are internal forces, induced in a structure, while external forces stress the same structure.

External forces induce structural stress such as:

- shearing stress
- bending moment

They increase their value from zero (wing tip) up to the maximum corresponding to the zone where the wing root connects to the fuselage.

The section involved in the check is bounded by the wing connection root of the fuselage.

The stress induced in aircraft section just described, beside the weight of the affected fuselage section, depends on:

- payload
- centre of gravity position in zero fuel weight condition.

ITA has developed a “load limitation form” to verify accordance to the shear load and bending moment limits, manually, by using the back side of A321-NEO aircraft balance chart form.

The procedure for shear load and bending moment must be applied when the following conditions take place at the same time:

- Actual Zero Fuel Weight (AZFW) coinciding to Maximum Zero Fuel Weight (MZFW)
- At least one ULD exceeds the gross weight of 700 Kg

Besides the common structural limitations for individual bay and cumulative, easily identified in 1.134kg for each containerized position and 1.497 kg for hold 5, on the back side of the balance chart there is a calculation table for control of limitations regarding the bending effect of weight on the aircraft structure flexibility between forward and aft.

The following method must be applied:

- Enter the weight and bending index related to the number of passengers in the boxes corresponding to passengers in each area (except for the 0b area, not to be considered as already included in the calculation), interpolation is not allowed, therefore, the highest value must be considered.
- Enter the actual weight and bending index of each bay in the corresponding boxes: interpolation is not allowed, so take the higher value (i.e. for an empty AKH container use the bending index related to 82 kg).
- Sum the weight and bending indexes of the forward and aft areas, thus obtaining two pair of results.
- Enter the % MAC value related to ZFW
- Check the structural limits, both forward and aft, related to the actual %MAC at ZFW to make sure that they are higher than the values resulted from the sum: if this does not happen, then load distribution must be changed in order to fall within the limitations.

 Volume II HLM	INFORMATION PER AIRCRAFT TYPE	5.4	Page 17
	A321 neo - ITA	Ed 2 Rev 6/15 nov 23	

5.4.6 USE OF MARKER CONES

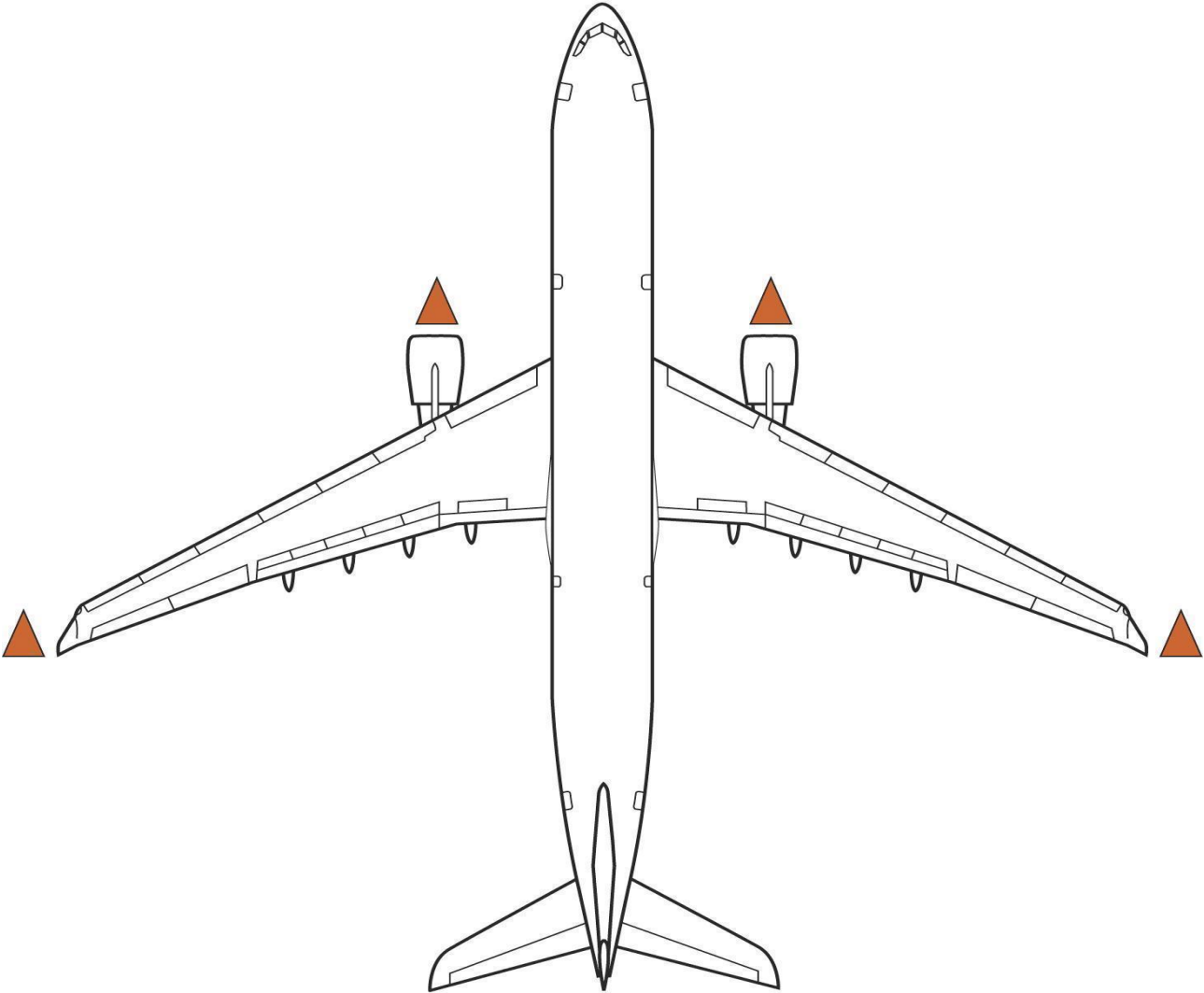

5.4.7 CHOCKING OF AIRCRAFT

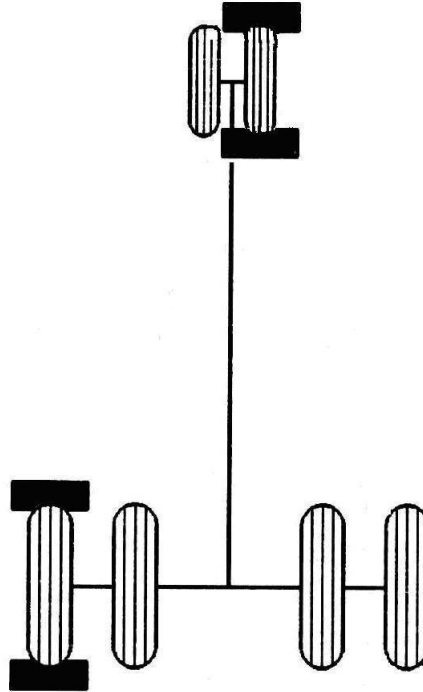

5.4.8 Chocking of aircraft with wind over 25kt (46.3 km/h)

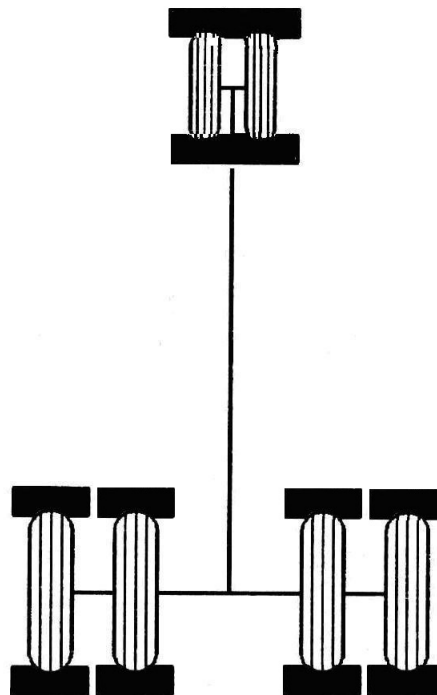

5.4.9 SERVICING ARRANGEMENTS

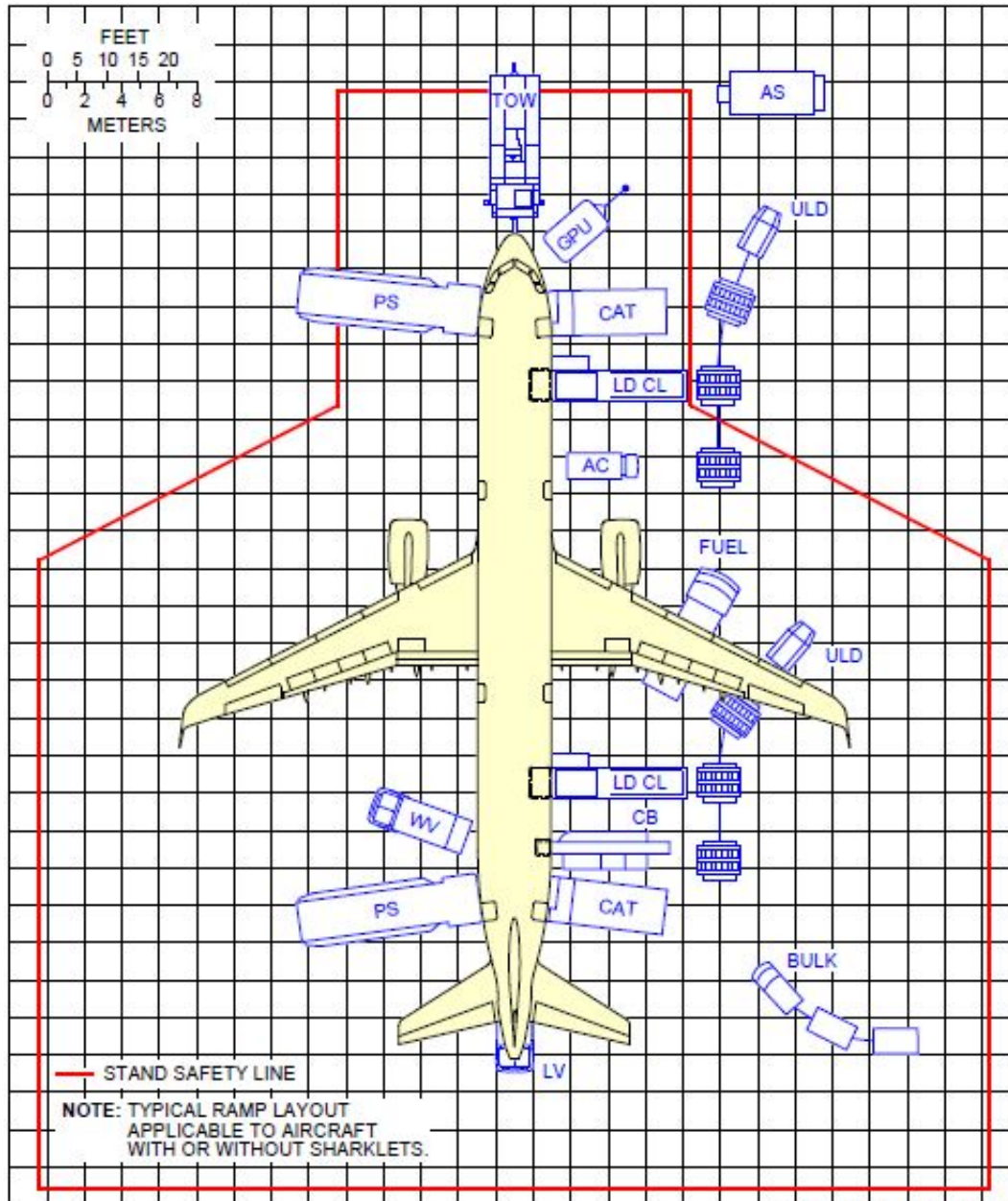

 ITA AIRWAYS Volume II HLM	INFORMATION PER AIRCRAFT TYPE	5.4	Page 20
	A321 neo - ITA	Ed 2 Rev 6/15 nov 23	

5.4.10 TOILETTE DRAIN

Below, the description of operational procedures for draining, flushing and filling of the chemical precharge.

1. Open service panel access door.
2. Unlock drain valve using unlock lever.
3. Connect the waste drain hose coupling to panel drain nipple and assure that the hose is well connected
4. Turn drain handle to unlock and pull until is fully extended and lock.
5. While the tanks drain, feel the drain hose and make sure that all waste is draining out.

Note: If the draining is not performed correctly, inform a Company representative.

6. Connect water supply hose coupling to the flush nipple.
7. Flush the tank using 25 litres of chemical precharge, the pressure must not exceed 50 PSI.
8. Close drain handle valve.
9. Remove the waste drain hose coupling to panel drain nipple and leave the fitting cap opened.
10. Fill 10 litres of disinfectant precharge solution.

Note: In case of leakage of chemical precharge from drain valves, inform a Company representative.

11. Closed the valves drain cap and latch the service panel.

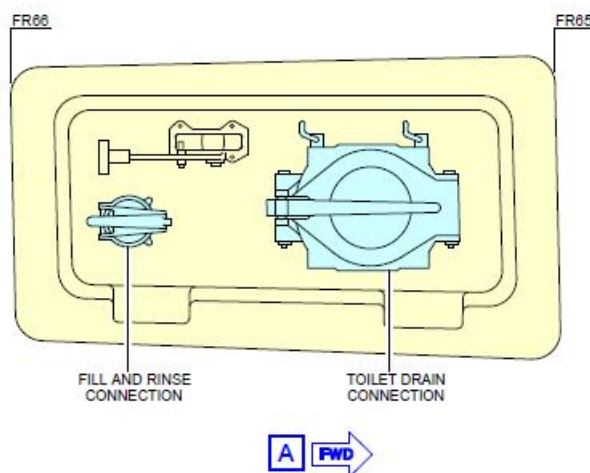
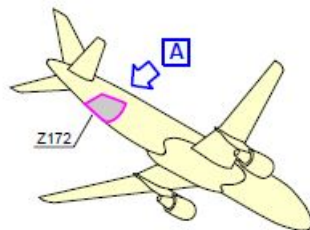

 ITA AIRWAYS Volume II HLM	INFORMATION PER AIRCRAFT TYPE	5.4	Page 21
	A321 neo - ITA	Ed 2 Rev 7/04 jan 24	

5.4.11 FILLING POTABLE WATER

The potable water supply on A321-NEO aircraft provides a **maximum of 200 litres (FULL level)** on potable water quantity indicator in aft service panel).

The aircraft can be partially filled in AUTOMATIC mode only. When the aircraft is not electrically powered, the potable water quantity indicator in aft service panel does not work and so it is not possible to fill the tank partially (i.e. 1/2). If the automatic mode should be unavailable, the MANUAL mode (not electrically powered aircraft) requires to fill the tank completely (200 litres of water - FULL).

The filling procedure described below includes both options (AUTOMATIC and MANUAL)

AUTOMATIC (electrically powered aircraft)

1. Open the aft service panel access door.
2. Remove fill nipple cap.
3. Connect fill service hose.
4. Turn the handle for the fill valve (*Filling/Draining Selector*) from NORMAL position to PULL TO FILL position and pull.
5. Open potable water source valve; the water pressure must not exceed 50 PSI.

Note: On aft service panel “*Overflow Valve Open*” come on showing that the electrically powered overflow valve, in centre panel, is opened.

6. Turn the handle for the fill valve (*Filling/Draining Selector*) from PULL TO FILL position to NORMAL position when the needle of potable water quantity indicator has reached the FULL level.
7. Close water supply valve and remove the service hose.
8. Check that there’s no leakage of water from the fill valve.

Note: In case of leakage inform a Company representative.

9. Install cap on fill nipple
10. Close and latch the aft service panel access door.

 ITA AIRWAYS Volume II HLM	INFORMATION PER AIRCRAFT TYPE	5.4	Page 22
	A321 neo - ITA	Ed 2 Rev 6/15 nov 23	

MANUAL

1. Open the aft service panel access door.
2. Remove fill nipple cap.
3. Connect fill service hose.
4. Open the central service panel access door.
5. Central service panel: turn “*Tank Overflow*” handle from CLOSED position to OPEN position.
6. Aft service panel: turn the handle for the fill valve (*Filling/Draining Selector*) from NORMAL position to PULL TO FILL position and pull.
7. Open potable water source valve and refill until water flows from the “*Overflow Port*”; the water pressure must not exceed 50 PSI.
8. Aft service panel: turn the handle for the fill valve (*Filling/Draining Selector*) from PULL TO FILL position to NORMAL position.
9. Central service panel: turn “*Tank Overflow*” handle from OPEN position to CLOSED position.
10. Close and latch the central service panel access door.
11. Close water supply valve and remove the service hose.
12. Check that there’s no leakage of water from the fill valve.

Note: In case of leakage inform a company representative.

13. Install cap on fill nipple.
14. Close and latch the aft service panel access door.

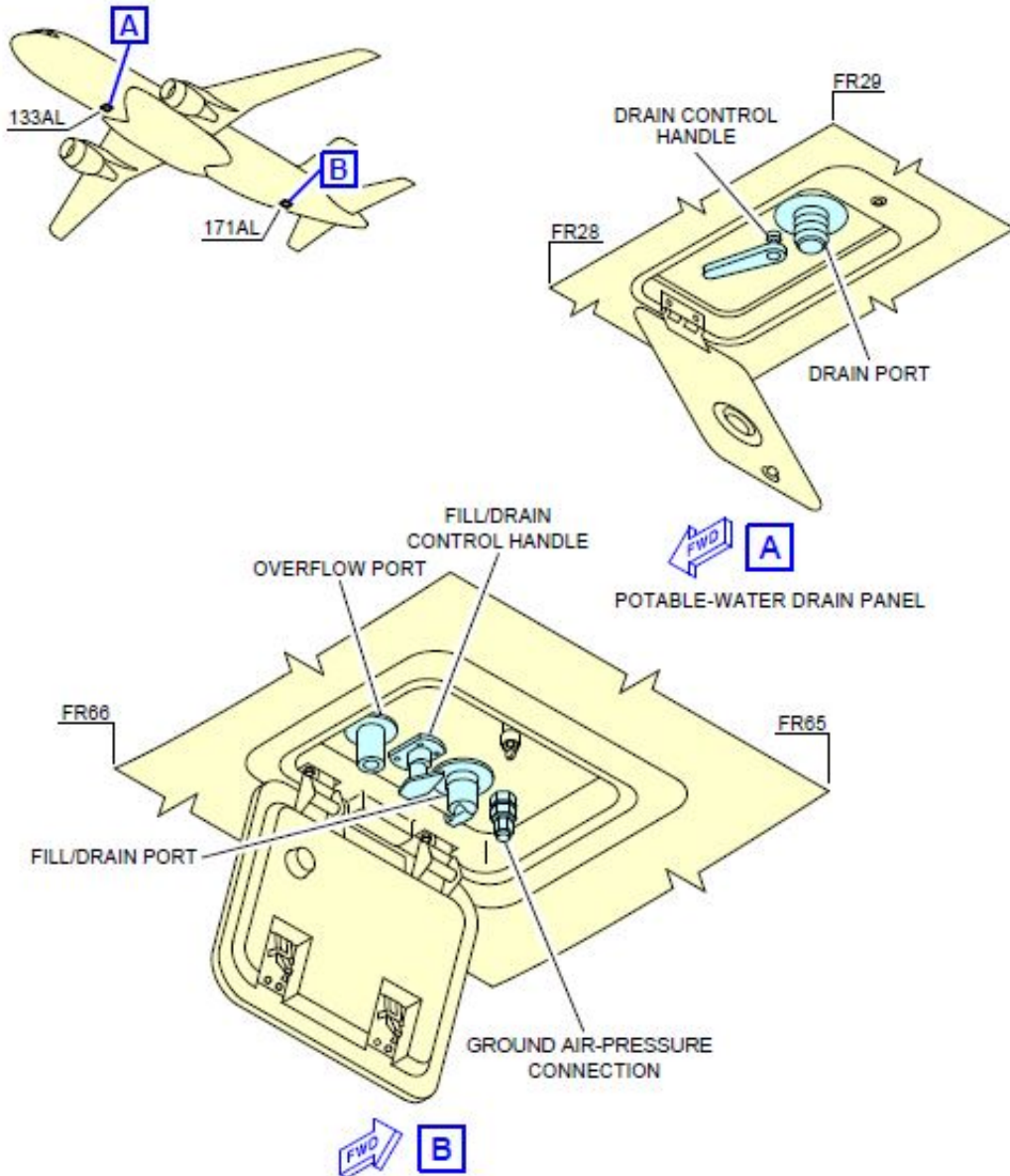

5.4.12 PRE DEPARTURE SERVICING CHECK LIST

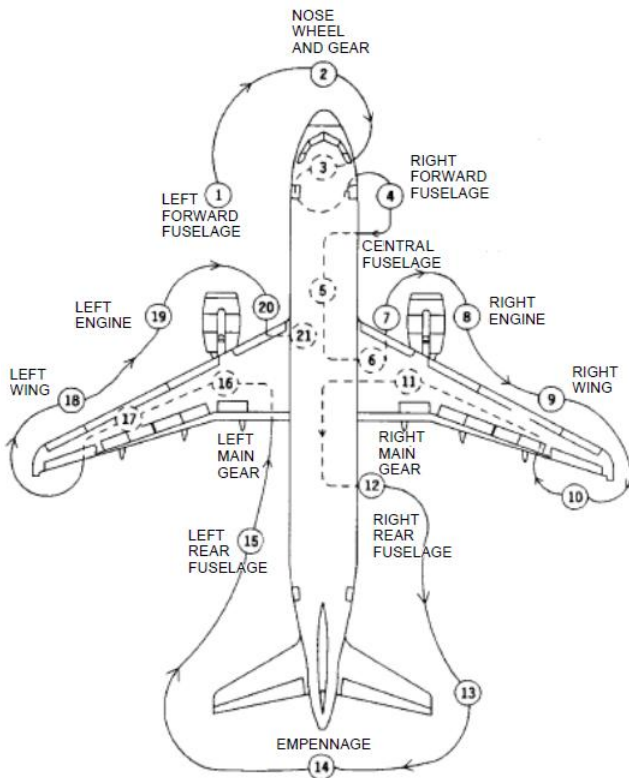

Pre Departure Servicing Check List A320F		
N°	Porzione aeromobile	Azione (*)
1	fusoliera anteriore sx	condizione
	porta pax anteriore sx	chiusa
2	tubo di pitot	condizione
	porte statiche	libere
	portello ground power	chiuso
3	tacchi nose gear (**)	in posizione
	or	
	push back track	connesso
	connessione ground power	chiusa e controllata
	ruote e pneumatici	condizione
	Hydraulic Safety Pin	connesso (push back) o rimosso (powerout)
4	fusoliera anteriore dx	condizione
	porta pax anteriore dx	chiusa e controllata
	porta cargo anteriore dx	chiusa e controllata
5	fusoliera centrale	condizione
	pannello acqua potabile	chiuso
	pannelli accesso LP e HP connection	chiusi
	luce anticollisione	accesa
6/9/10	ala dx	condizione
	pannello carburante	chiuso
7/8	motore dx	condizione
11	tacchi landing gear dx (**)	rimossi
	ruote e pneumatici	condizione
12	fusoliera posteriore dx	condizione
	porta cargo posteriore	chiusa e controllata
	porta pax posteriore dx	chiusa e controllata
	porta bulk	chiusa e controllata
	pannello toilette service	chiuso
13	impennaggio	condizione
14	scarico	libero
15	fusoliera posteriore sx	condizione
	porta pax posteriore sx,	chiusa e controllata
	pannello acqua potabile	chiuso
16	tacchi landing gear sx (**)	rimossi
	ruote e pneumatici	condizione
17/18/21	ala sx	condizione
19/20	motore sx	condizione
(*) per <i>condizione</i> è da intendersi il controllo delle anomalie quali: danni evidenti, perdite copiose di liquidi e che le maniglie dei portelli non fuoriescano dal profilo della fusoliera		
(**) assicurarsi che il parking brake venga inserito prima di rimuovere i tacchi		

 ITA AIRWAYS Volume II HLM	INFORMATION PER AIRCRAFT TYPE	5.4	Page 25
	A321 neo - ITA	Ed 2 Rev 6/15 nov 23	

5.4.13 SAFETY AREAS

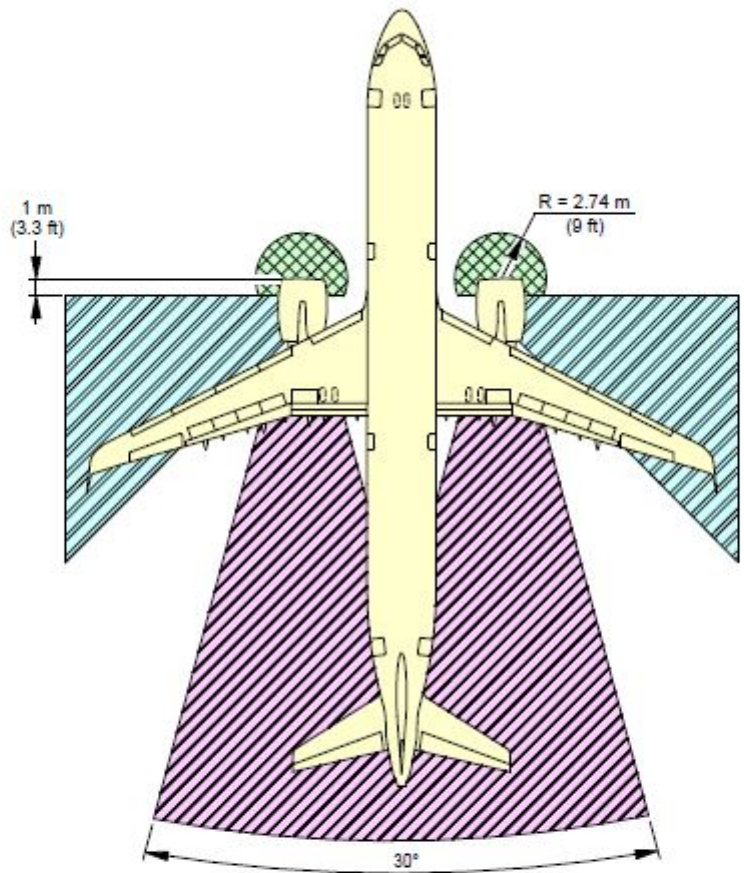

5.4.13.1 Idle thrust - Intake and Blast areas

The Intake and Blast areas at Idle thrust of the aircraft must be observed and no personnel and equipment must stay within these areas when the engines are operating. The Blast areas refer to the area behind the aircraft, starting from the aft end of operating engines. The safety distances shown in the table below must be observed.



TO 40.3 m (132 ft) AFT OF COMMON NOZZLE ASSEMBLY (CNA)
INCLUDES CROSS WIND EFFECT

NOTE:

-  INTAKE SUCTION DANGER AREA MINIMUM IDLE POWER
-  ENTRY CORRIDOR
-  EXHAUST DANGER AREA

5.4.14 Steering limits

steering angle	R1 right main landing gear (RMLG)	R2 left main landing gear(LMLG)	R3 nose landing gear (NLG)	R4 wing		R5 nose	R6 tail
				wingtip	sharklet		
20	44.3 m	51.9 m	50.7 m	64.7 m	65.5 m	52.3 m	57.9 m
25	34 m	41.6 m	41.1 m	54.3 m	55.2 m	43.1 m	48.5 m
30	26.9 m	34.5 m	34.7 m	47.3 m	48.1 m	37.2 m	42.2 m
35	21.7 m	29.3 m	30.3 m	42.1 m	42.9 m	33.1 m	37.8 m
40	17.6 m	25.2 m	27 m	38.1 m	38.9 m	30.2 m	34.6 m
45	14.4 m	22 m	24.6 m	34.8 m	35.6 m	28.1 m	32.1 m
50	11.7 m	19.3 m	22.7 m	32.1 m	32.9 m	26.5 m	30.2 m
55	9.4 m	16.9 m	21.2 m	29.8 m	30.7 m	25.3 m	28.6 m
60	7.3 m	14.9 m	20 m	27.8 m	28.6 m	24.3 m	27.4 m
65	5.5 m	13.1 m	19.1 m	26.1 m	26.9 m	23.6 m	26.3 m
70	3.9 m	11.5 m	18.4 m	24.5 m	25.3 m	23.1 m	25.4 m
75 (MAX)	2.5 m	10.1 m	17.9 m	23.1 m	23.9 m	22.7 m	24.7 m

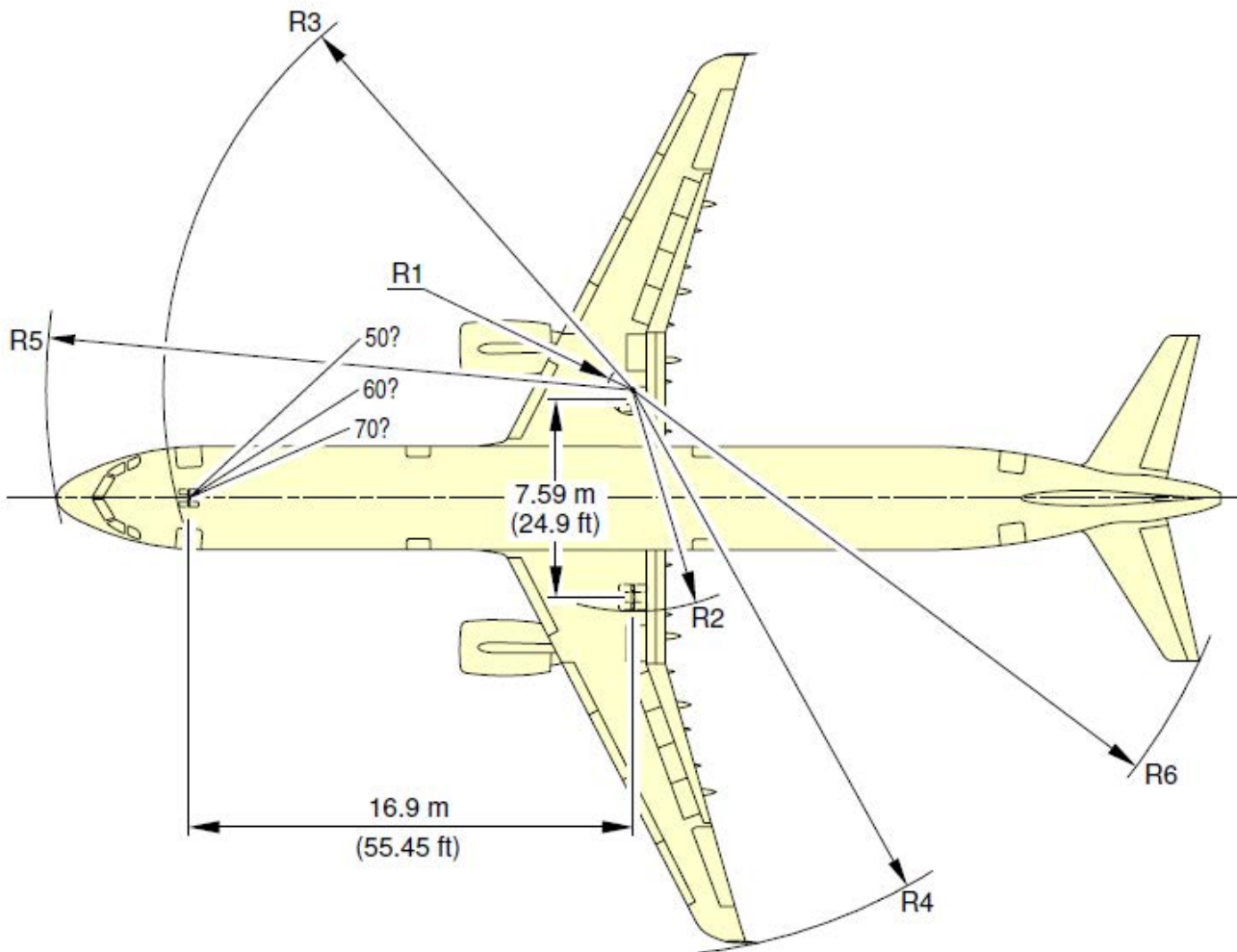

 ITA AIRWAYS Volume II HLM	INFORMATION PER AIRCRAFT TYPE	5.5	Page 1
	A320/200 - A320 neo - ITA	Ed 2 Rev 2/26 jan 23	

5.5 A320/200 - A320 neo - ITA

5.5.1 HOLDS

5.5.1.1 Cargo compartment specifications A320/200

CARGO COMPARTMENT SPECIFICATIONS A-320/200	
MAX CARGO/BAGS CAPACITY	Kg 9.435
MAX CARGO/BAGS VOLUME	m ³ 31,6
FORWARD COMPARTMENTS 1	3 AKH CONTAINERS or 3 PKC PALLET in any INTERMIX
AFT COMPARTMENTS 3-4	4 AKH CONTAINERS or 4 PKC PALLET in any INTERMIX
COMPARTMENT 5	Kg 1.497 - Kg 1.122 Volume m ³ 5,9 BULK LOAD

Compartments **1-3-4** are equipped to load **AKH** containers (whose capacity can reach up to 25 bags each approx.) or **PKC** pallets (specific for live animals or for coffins with human remains or generally speaking for those conventional shipments which are not compatible with an AKH container).

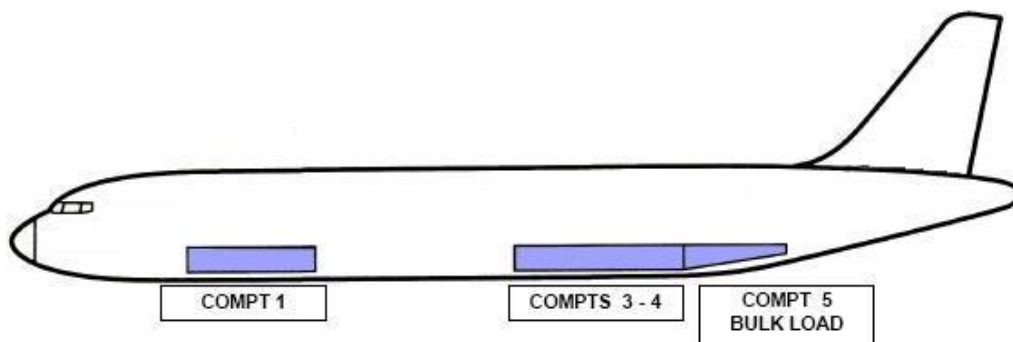

BULK LOAD IS FORBIDDEN IN COMPARTMENTS 1-3-4

The bays of compartment 1 are named 11, 12 and 13, while in compartment 3 they are named respectively 31 and 32, the same way in compartment 4, two bays named 41 and 42.

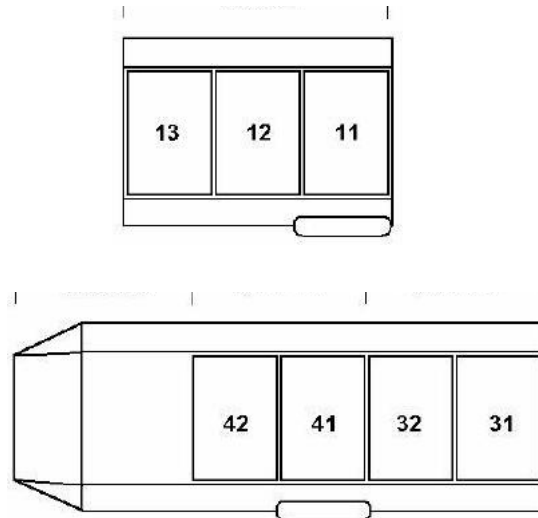

Each lock shall be always armed on empty ULD position (even if the hold is completely empty). The following table shows the suggested loading sequence of ULD in each hold.

LOADING SEQUENCE OF ULDS								
	Forward Hold Positions				Aft Hold Positions			
	11	12	13		31	32	41	42
1 ULD	x			1 ULD			x	
2 ULD	x	x		2 ULD		x	x	
3 ULD	x	x	x	2 ULD			x	x
				3 ULD	x	x	x	
				3 ULD		x	x	x
				4 ULD	x	x	x	x

Intermix between forward and aft holds options is allowed.

For example, in case of loading of 2 ULDs on an aircraft, the possible configurations are:

- a. 2 ULDs on forward hold (positions 11 -12),
- b. 1 ULD on forward hold + 1 ULD on aft hold (positions 11 - 41),
- c. 2 ULDs on aft hold (positions 32 - 41 or 41 - 42).





Attention:

In the case of inoperative positions in the FWD and AFT compartments, the LC is allowed to plan the load in the remaining operational positions, while still guaranteeing the loading sequence with the exclusion of the inoperative position

 Volume II HLM	INFORMATION PER AIRCRAFT TYPE	5.5	Page 3
	A320/200 - A320 neo - ITA	Ed 2 Rev 2/26 jan 23	

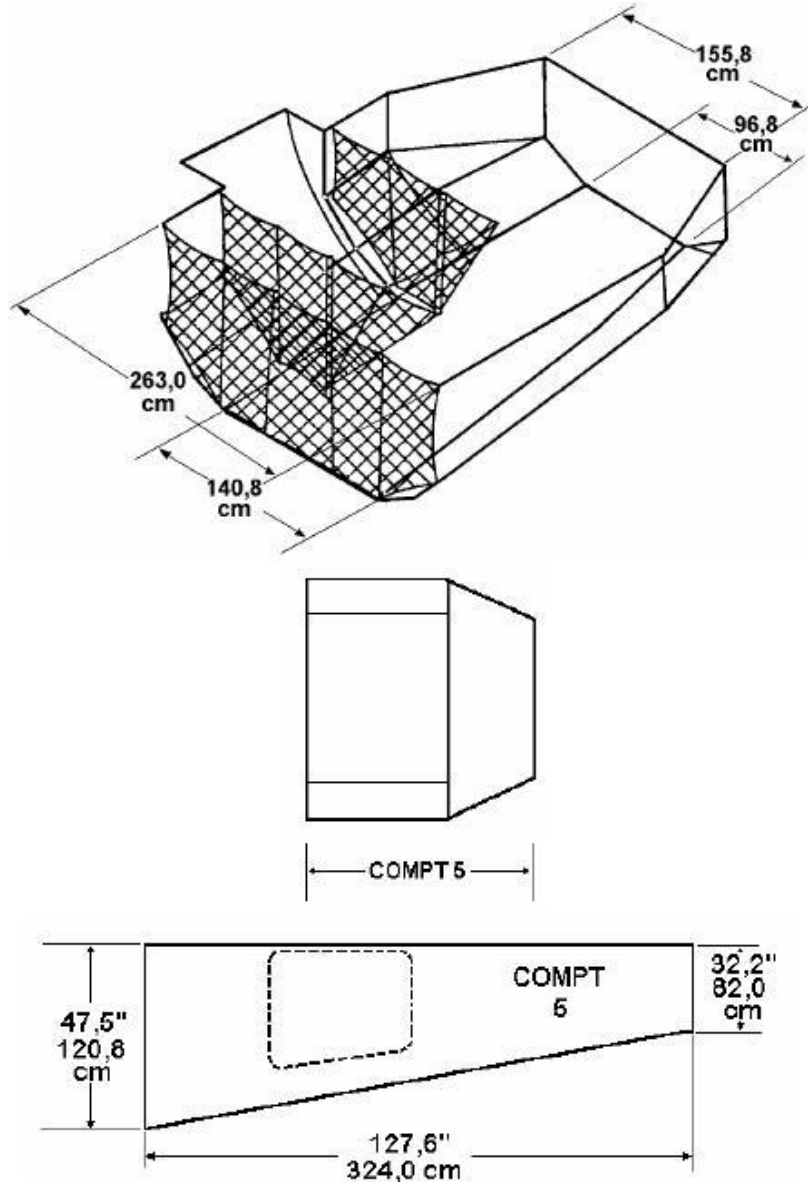
Compartment 5 “bulk” is dedicate to loose shipments. For aircraft without door for such compartment, loading is performed via compartment 4, specifically from position 42: they are separated by a net which has to be correctly **installed and operative**, otherwise compartment 5 cannot be used unless **all loads are individually tied down on the floor**.



 ITA AIRWAYS Volume II HLM	INFORMATION PER AIRCRAFT TYPE	5.5	Page 4
	A320/200 - A320 neo - ITA	Ed 2 Rev 17/27 jan 26	



Due to fire extinguishing system feature, shipments containing Dangerous Goods (DG) as flammable and combustibles (class 2.1, 3 and 4) shall be loaded necessarily in the compartments 1 or 5. Segregation criteria shall be always respected (i.e. in case of DG class 2.1, 3 and 4, lithium-ion, lithium metal and sodium-ion batteries shall be loaded exclusively in the compartments 3-4).

COMPARTMENT	SURFACE RESISTANCE (Kg/m ²)	USABLE VOLUME (m ³)	MAX STRUCRAL LOAD (Kg)
1	488	11,04	3.402
3		7,36	2.268
4		7,36	2.268
5	732	5,88 4,7 (*)	1.497 1.122 (*)

Note: Maximum structural loads include the ULD tare weight.

Compartments **1-3-4** are equipped with a Cargo Loading System for the loading/unloading of ULDs and are certified even for transportation of non-certified ULD..

Cargo holds are pressurized and have the following systems installed:

- smoke detection system,
- fire extinguishing system,
- ventilation system (compartments 3 - 4 - 5).

MAXIMUM ULD LOAD PER POSITION (Kg)
ULD base dimensions (inches)
60.4 x 61.5 (AKH-PKC)
1.134

 ITA AIRWAYS Volume II HLM	INFORMATION PER AIRCRAFT TYPE	5.5	Page 5
	A320/200 - A320 neo - ITA	Ed 2 Rev 2/26 jan 23	

5.5.2 CLS malfunctions

fwd hold

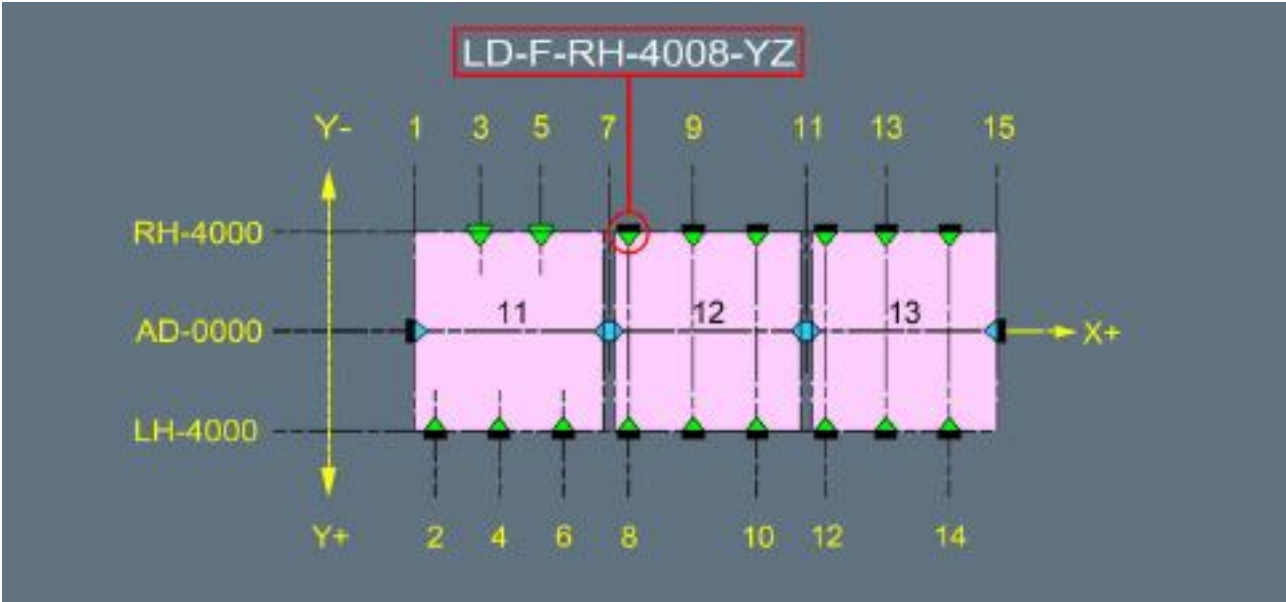

aft hold

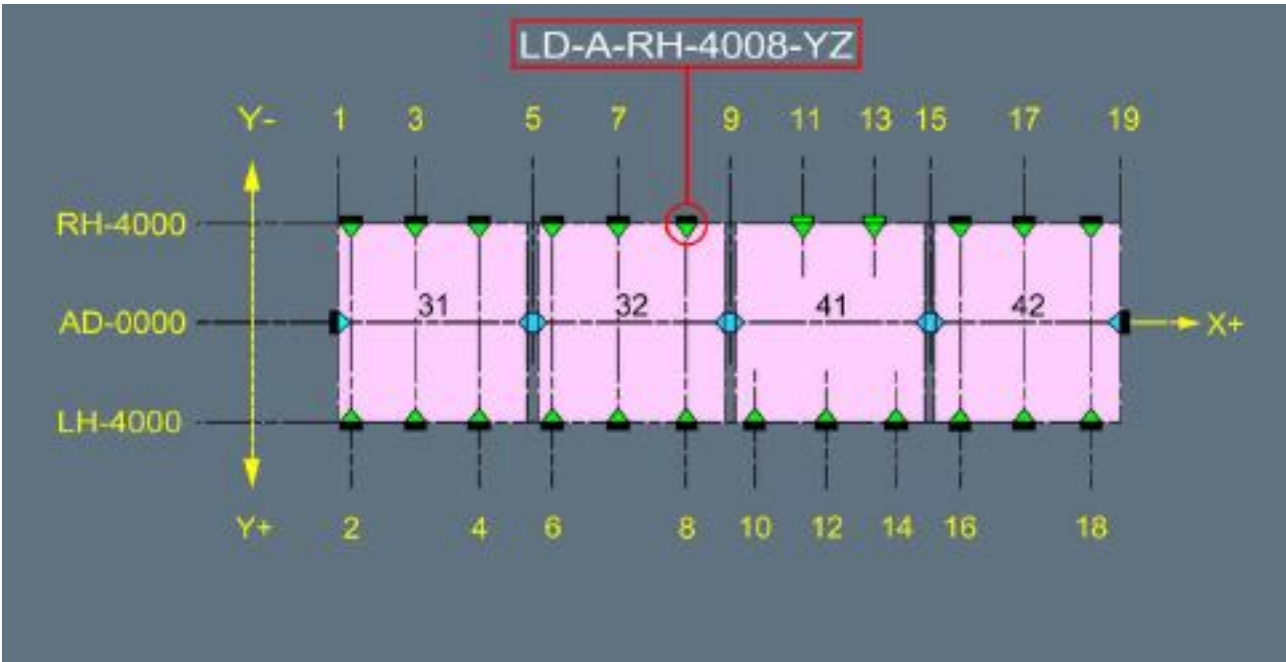

Latch type	position	latch code	failed latch per position	required conditions
XZ - single latch	11, 12	LD-F-AD-0007-XZ	1 latch	ULD removed
	12, 13	LD-F-AD-0011-XZ	1 latch	ULD removed
YZ - latch	11	LD-F-LH-4002-YZ	1 latch	ULD empty
		LD-F-LH-4004-YZ LD-F-LH-4006-YZ	2 or more latches	ULD removed
	12	LD-F-RH-4008-YZ LD-F-LH-4008-YZ	1 latch	ULD empty
		LD-F-RH-4009-YZ LD-F-LH-4009-YZ LD-F-RH-4010-YZ LD-F-LH-4010-YZ	2 or more latch	ULD removed
	13	LD-F-RH-4012-YZ LD-F-LH-4012-YZ	1 latch	ULD empty
		LD-F-RH-4013-YZ LD-F-LH-4013-YZ LD-F-RH-4014-YZ LD-F-LH-4014-YZ	2 or more latches	ULD removed
YZ - latch (door sill)	11	LD-F-RH-4003-YZ LD-F-RH-4005-YZ	1 or more latches	ULD removed
XZ - latch (end stop)	11	LD-F-AD-001-XZ	1 latch	ULD removed
	13	LD-F-AD-0015-XZ	1 latch	ULD removed
XZ - single latch	31, 32	LD-A-AD-0005-XZ	1 latch	ULD removed
	32, 41	LD-A-AD-0009-XZ	1 latch	ULD removed
	41, 42	LD-A-AD-0015-XZ	1 latch	ULD removed

 Volume II HLM	INFORMATION PER AIRCRAFT TYPE		5.5	Page 7
	A320/200 - A320 neo - ITA			Ed 2 Rev 2/26 jan 23

YZ - latch	31	LD-A-RH-4002-YZ	1 latch	ULD empty
		LD-A-LH-4002-YZ	2 or more latches	ULD removed
	LD-A-RH-4003-YZ	2 or more latches		
	LD-A-RH-4003-YZ		2 or more latches	ULD removed
	LD-A-RH-4004-YZ	2 or more latches		
	LD-A-LH-4004-YZ		2 or more latches	ULD removed
	32	LD-A-RH-4006-YZ		
		LD-A-LH-4006-YZ	2 or more latches	ULD removed
	LD-A-RH-4007-YZ	2 or more latches		
	LD-A-LH-4007-YZ		2 or more latches	ULD removed
	LD-A-RH-4008-YZ	2 or more latches		
	LD-A-LH-4008-YZ		2 or more latches	ULD removed
41	LD-A-LH-4010-YZ	1 latch		
	LD-A-LH-4012-YZ	2 or more latches	ULD removed	
LD-A-LH-4014-YZ	2 or more latches			ULD removed
42		LD-A-RH-4016-YZ	1 latch	
	LD-A-LH-4016-YZ	2 or more latches	ULD removed	
LD-A-RH-4017-YZ	2 or more latches			ULD removed
LD-A-LH-4017-YZ		2 or more latches	ULD removed	
LD-A-RH-4018-YZ	2 or more latches			ULD removed
LD-A-LH-4018-YZ		2 or more latches	ULD removed	
YZ- latch (door sill)	41			LD-A-RH-4011-YZ
		LD-A-RH-4013-YZ		
XZ- latch (end stop)	31	LD-A-AD-0001-XZ	1 latch	ULD removed
	42	LD-A-AD-0019-XZ	1 latch	ULD removed
For one applicable position, the failed latches are of different types				ULD removed

Legenda:

LD - Lower Deck

F - Forward Hold

A - Aft Hold

RH - Right hand Side

LH - Left hand Side

AD - Aircraft Datum

XZ - Restraint in X and Z directions

YZ - Restraint in Y and Z directions

 Volume II HLM	INFORMATION PER AIRCRAFT TYPE	5.5	Page 8
	A320/200 - A320 neo - ITA	Ed 2 Rev 9/14 jun 24	

5.5.2.1 Intentionally left blank

 Volume II HLM	INFORMATION PER AIRCRAFT TYPE	5.5	Page 9
	A320/200 - A320 neo - ITA	Ed 2 Rev 2/26 jan 23	

5.5.2.2 Cargo compartment temperature and ventilation

The following table shows all necessary information for the transportation of goods that need specific temperature and ventilation on board this kind of aircraft.

COMPARTMENT	TEMPERATURE RANGE	VENTILATION	GROUND CONTROL	COCKPIT CONTROL
1	2°C - 4°C	NO	NO	NO
3 - 4	5°C - 15°C - 26°C	YES	NO	YES
5	5°C - 15°C - 26°C	YES	NO	YES

5.5.2.3 Resistance of fittings

All compartments can host single tie-down fittings for the restraint of bulk loads.

In compartments **1-3-4** they are located on the floor, while in compartment **5** they are on the floor, along the sides and on the ceiling.

The following table shows the fittings minimum resistance in every direction.

COMPARTMENT	MINIMUM RESISTANCE
1 - 3 - 4 - 5	2000 LB / 907 Kg

The resistance can be calculated by multiplying the fittings resistance by the coefficient related to the angle (9.3.3 "LOAD RESTRAINT FACTORS").

DIRECTION	COMPARTMENT	RESTRAINT FACTOR
FORWARD	ALL	1,69 G
BACKWARD	ALL	1,12 G
RIGHT - LEFT	1	0,88 G
	3	1,46 G
	4	1,72 G
	5	2,15 G
UPWARD	1	2,57 G
	3	3,01 G
	4	3,53 G
	5	4,26 G

 Volume II HLM	INFORMATION PER AIRCRAFT TYPE	5.5	Page 10
	A320/200 - A320 neo - ITA	Ed 2 Rev 2/26 jan 23	

5.5.2.4 Forward and aft cargo door maximum dimensions

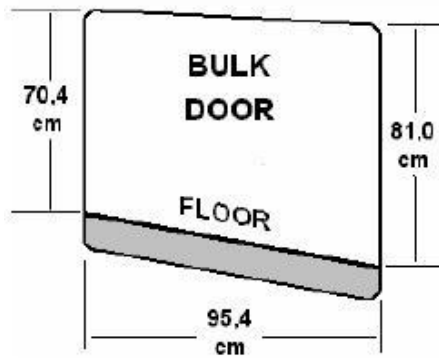
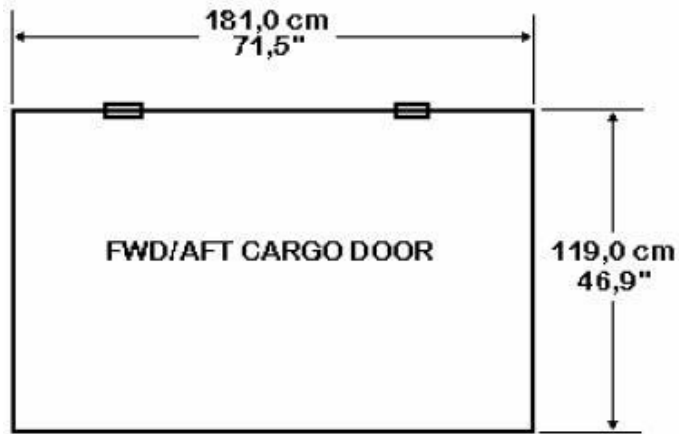

5.5.2.5 Maximum dimensions for conventional load in compartment 5

MAXIMUM DIMENSIONS FOR CONVENTIONAL LOADS IN COMPARTMENT 5 WITH LOADING THROUGH COMPARTMENT 5 CARGO DOOR

WIDHT	HEIGHT	
	0.400 m	0.600 m
	LENGHT	
0.000	2.155	1.989
0.100	2.100	1.815
0.200	2.053	1.613
0.300	1.957	1.409
0.400	1.757	1.203
0.500	1.556	0.991
0.600	1.355	-
0.700	1.154	-
0.800	0.959	-

MAXIMUM DIMENSIONS FOR CONVENTIONAL LOADS IN COMPARTMENT 5 WITH LOADING THROUGH COMPARTMENT 4 CARGO DOOR

WIDHT	HEIGHT				
	0.400 m	0.600 m	0.750 m	0.900 m	1.000m
	LENGHT				
0.000	2.664	2.601	2.585	2.050	1.031
0.100	2.618	2.574	2.497	2.031	0.975
0.200	2.580	2.557	2.384	2.017	0.965
0.300	2.552	2.381	2.269	1.715	0.965
0.400	2.533	2.219	2.149	1.715	-
0.500	2.443	1.965	1.907	1.715	-
0.600	2.313	-	-	-	-
0.700	2.177	-	-	-	-
0.800	2.031	-	-	-	-
0.900	1.809	-	-	-	-

The maximum allowed weight for each item loaded in compartment 5 is 70 kg each

 Volume II HLM	INFORMATION PER AIRCRAFT TYPE	5.5	Page 12
	A320/200 - A320 neo - ITA	Ed 2 Rev 2/26 jan 23	

5.5.3 LOADING PROCEDURE FOR A320 CONTAINERIZED A/C IN STATIONS WITHOUT SUITABLE LOADER

In order to guarantee the operations in stations without suitable loader to handle a A320 containerized, it is mandatory to follow some instructions on how to load/unload holds.

In station without suitable loader, AKH containers and PKC pallets shall not be offloaded. Baggage offloading will be done totally manually or with the support of a conveyor belt.

Loading of baggage in holds must be performed in order to not allow subsequent stations, during loading/offloading operations, to remove transit baggage.

From departing stations and/or transit stations a full fit configuration is required as follows:

- 3 AKH containers in 13, 31 and 42 positions.
- 4 PKC pallets with appropriate nets in 11, 12, 32 and 41 positions.

All containers must be loaded with the opening facing the hold doors, in order to allow baggage handling in the hold.

Person in charge for planning and issuing the “loading instructions” and the loading Supervisor shall verify that what expected on board, in weight, dimensions and volume terms, is compatible with the current procedure and with the type of aircraft used. In case of irregularities, the Station Manager or its delegate shall be informed promptly.

Station Manager or its delegate shall verify that the current procedure is aligned with local regulation and legislation.

 Volume II HLM	INFORMATION PER AIRCRAFT TYPE	5.5	Page 13
	A320/200 - A320 neo - ITA	Ed 2 Rev 14/05 jun 25	

5.5.3.1 Cross section of compartments 1-3-4 - internal dimensions for the loading of conventional loads

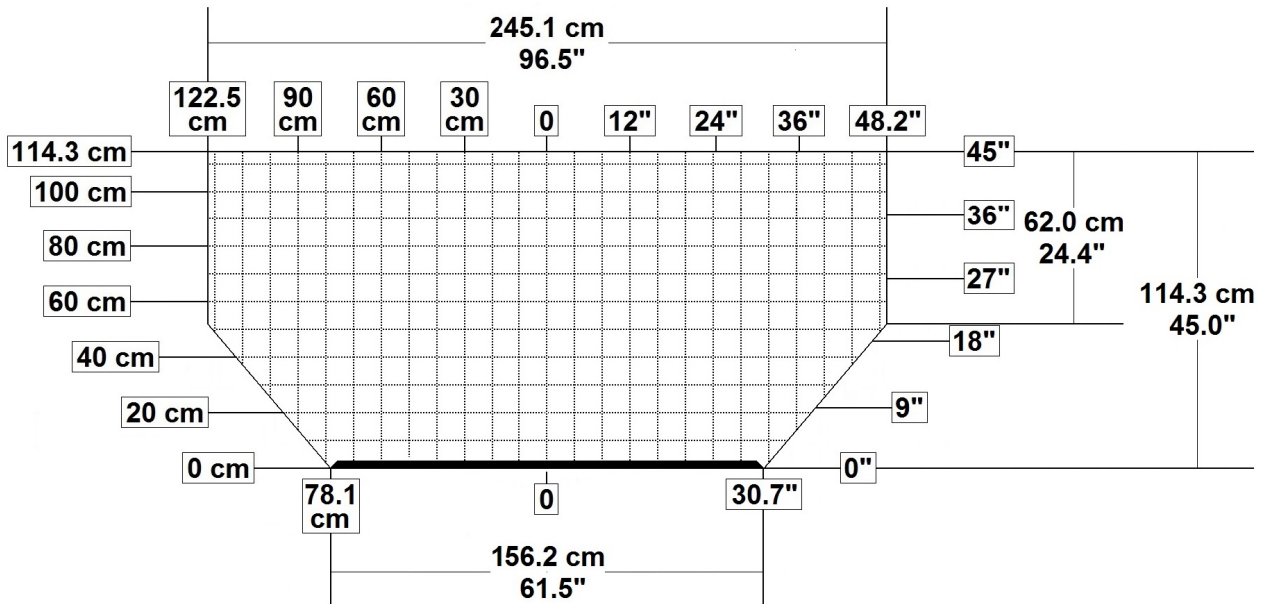

Notes:

- the side of each square is 10 cm (4,0") long,
- those given are the maximum dimensions: pallets must be built up in such a way as to keep the 5 cm / 2" minimum clearance from ceiling lights, smoke detectors and compartment contour,
- the pallet is about 2,5 cm (1") thick, and should be subtracted from the available height.

The pallets maximum height shall not exceed 114 cm / 45"

Overhangs on short sides of pallet based 60.4"x61.5" are allowed

Overhangs on long side (61.5") of pallet based 60.4"x61.5" are allowed up to 3.1" (8 cm) provided that the overhang is not positioned next front / rear bulkheads and that a related obliged clearance is built in the adjoining pallet, if necessary

5.5.4 FUEL

The A320 has three tanks: one centre tank and two wing tanks. The following table shows their capacity in kg. as to weight and in litres as to volume.

	320-214		Enhanced		A320 neo	
	WEIGHT Kg	VOLUME Lt	WEIGHT Kg	VOLUME Lt	WEIGHT Kg	VOLUME Lt
LEFT WING TANK	6127	7805	6265	7980	6074	7738
RIGHT WING TANK	6127	7805	6265	7980	6074	7738
CENTER TANK	6476	8250	6476	8250	6475	8428
TOTAL	18730	23860	19005	24210	18623	23904

To determine the influence of fuel loading on the aircraft's centre of gravity, use the fuel pattern diagram on the back page of the balance chart form, as shown below, paying attention to the following alert:

A320/200

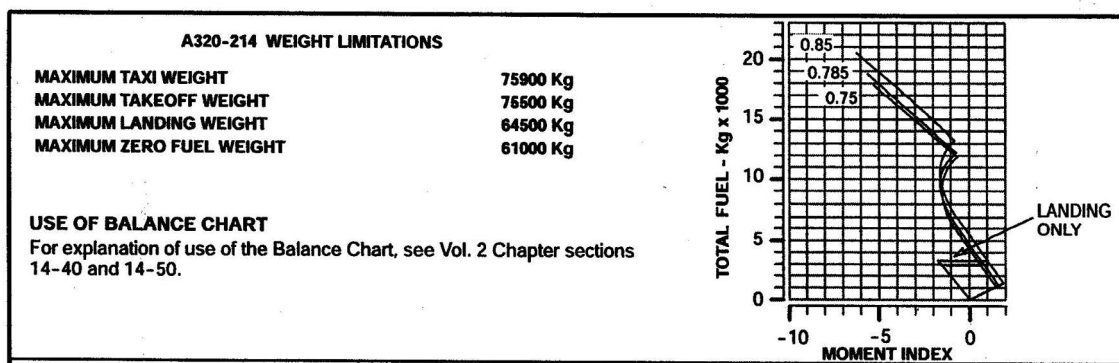

As evidenced by the fuel pattern above, the trip curve shows an anomaly, as it is significantly different from the fuel loading curve, during the descent and landing phases; due to this anomaly, when fuel burning reaches about 3.000kg from Zero Fuel, the center of gravity of the aircraft moves dramatically and significantly towards left side, for **just less than 3 moment index**, and then comes to align again over the loading curve.

The DCS automated system is able to evaluate this anomaly by limiting the C.G. excursion range area at Zero; while, in case of manual elaboration of the balance chart, the following rule shall absolutely be applied:

IN CASE OF NOSE DOWN BALANCE CONDITIONS, THE C.G. AT ZFW SHALL BE AT LEAST 3 M.I. TO THE RIGHT OF THE FORWARD OPERATIVE LIMIT !

A320 neo

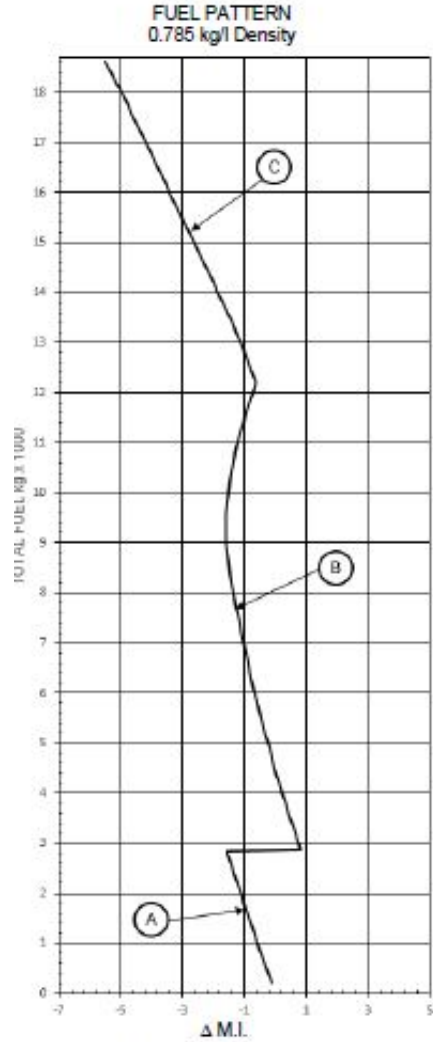

A – INNER TANKS (OUTER TANKS EMPTY)
B – INNER TANKS (OUTER TANKS FULL)
C – CENTER TANK

WEIGHT LIMITATIONS WV 051 WV 053		
→	MAXIMUM TAXI WEIGHT	73900 kg 77400 kg
→	MAXIMUM TAKEOFF WEIGHT	73500 kg 77000 kg
	MAXIMUM LANDING WEIGHT	67400 kg
	MAXIMUM ZERO FUEL WEIGHT	64300 kg
	MINIMUM WEIGHT	40300 kg
MAXIMUM STRUCTURAL LOAD		
	Compt 1	3402 kg
	Compt 3	2426 kg
	Compt 4	2110 kg
	Compt 5	1497 kg
MAXIMUM CUMULATIVE LOAD		
	FWD (Compt 1)	3402 kg
	AFT (Compt 3 + Compt 4)	4536 kg
	REAR (Compt 5)	1497 kg

 Volume II HLM	INFORMATION PER AIRCRAFT TYPE	5.5	Page 16
	A320/200 - A320 neo - ITA	Ed 2 Rev 2/26 jan 23	

5.5.5 LOAD LIMITATIONS

5.5.5.1 Shear and bending moment limitations

Shear load and bending moment are internal forces, induced in a structure, while external forces stress the same structure.

External forces induce structural stress such as:

- shearing stress
- bending moment

They increase their value from zero (wing tip) up to the maximum corresponding to the zone where the wing root connects to the fuselage.

The section involved in the check is bounded by the wing connection root of the fuselage.

The stress induced in aircraft section just described, beside the weight of the affected fuselage section, depends on:

- payload
- centre of gravity position in zero fuel weight condition.

ITA has developed a “load limitation form” to verify accordance to the shear load and bending moment limits, manually, by using the back side of A320 Family aircraft balance chart form.

The procedure for shear load and bending moment must be applied when the following conditions take place at the same time:

- Actual Zero Fuel Weight (AZFW) coinciding to Maximum Zero Fuel Weight (MZFW)
- At least one ULD exceeds the gross weight of 700 Kg

Besides the common structural limitations for individual bay and cumulative (see balance chart), on the back side of the balance chart there is a calculation table for control of limitations regarding the bending effect of weight on the aircraft structure flexibility between forward and aft.

The following method must be applied:

- Enter the weight and bending index related to the number of passengers in the boxes corresponding to passengers in each area (except for the 0b area, not to be considered as already included in the calculation), interpolation is not allowed, therefore, the highest value must be considered.
- Enter the actual weight and bending index of each bay in the corresponding boxes: interpolation is not allowed, so take the higher value (i.e. for an empty AKH container use the bending index related to 82 kg).
- Sum the weight and bending indexes of the forward and aft areas, thus obtaining two pair of results.
- Enter the % MAC value related to ZFW
- Check the structural limits, both forward and aft, related to the actual %MAC at ZFW to make sure that they are higher than the values resulted from the sum: if this does not happen, then load distribution must be changed in order to fall within the limitations.

 ITA AIRWAYS Volume II HLM	INFORMATION PER AIRCRAFT TYPE	5.5	Page 17
	A320/200 - A320 neo - ITA	Ed 2 Rev 2/26 jan 23	

5.5.6 USE OF MARKER CONES

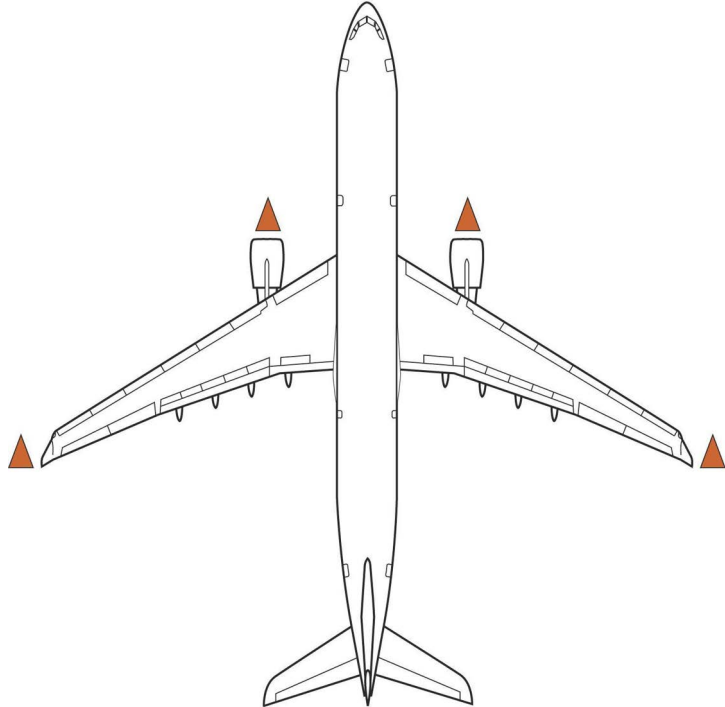

5.5.7 CHOCKING OF AIRCRAFT

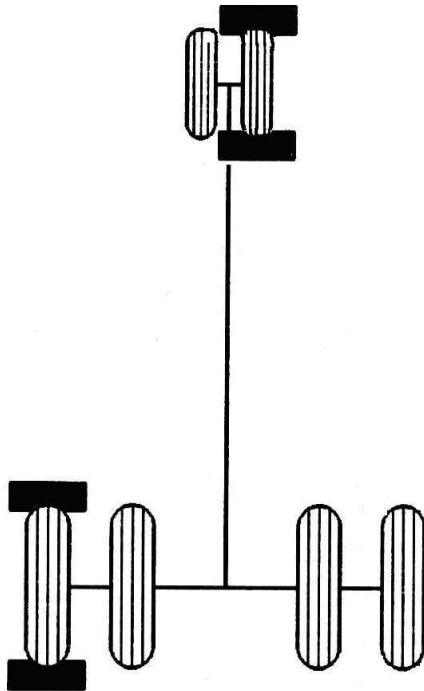

 Volume II HLM	INFORMATION PER AIRCRAFT TYPE	5.5	Page 18
	A320/200 - A320 neo - ITA	Ed 2 Rev 2/26 jan 23	

5.5.8 Chocking of aircraft with wind over 25kt (46.3 km/h)

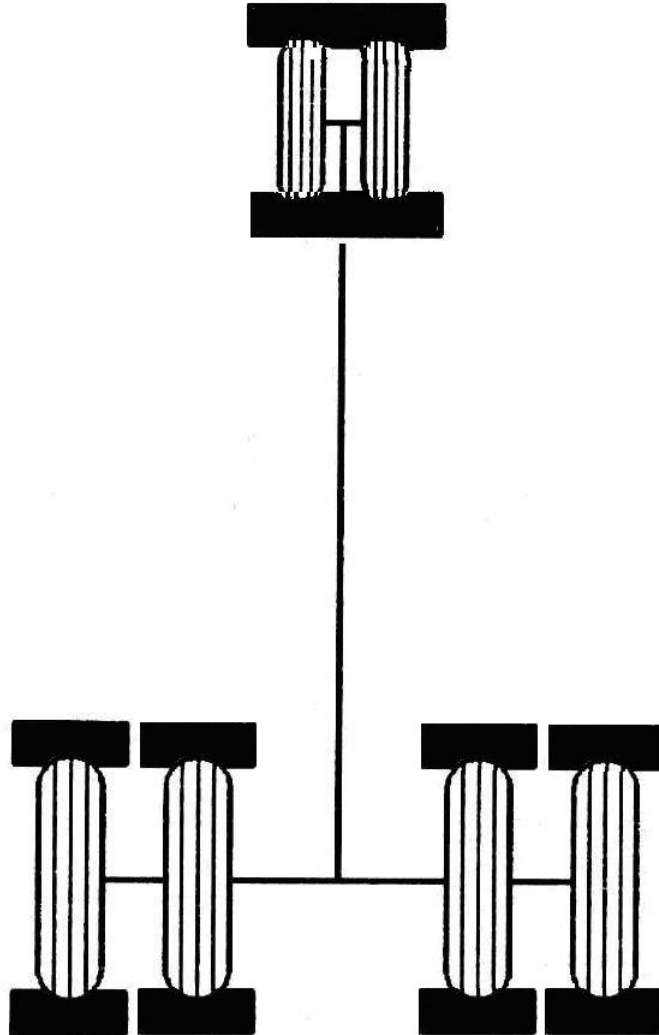

5.5.9 SERVICING ARRANGEMENTS

A320/200

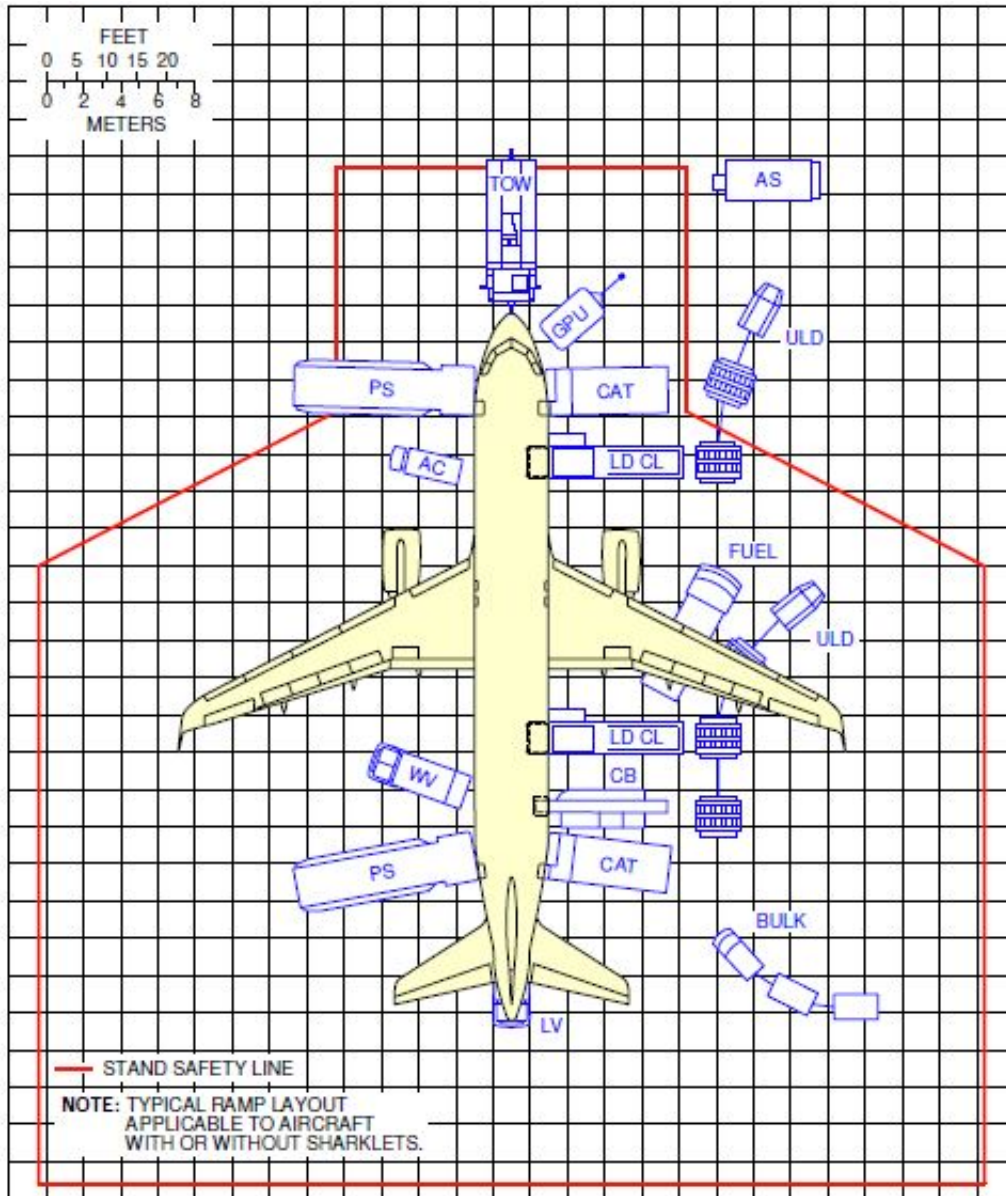

A320/neo

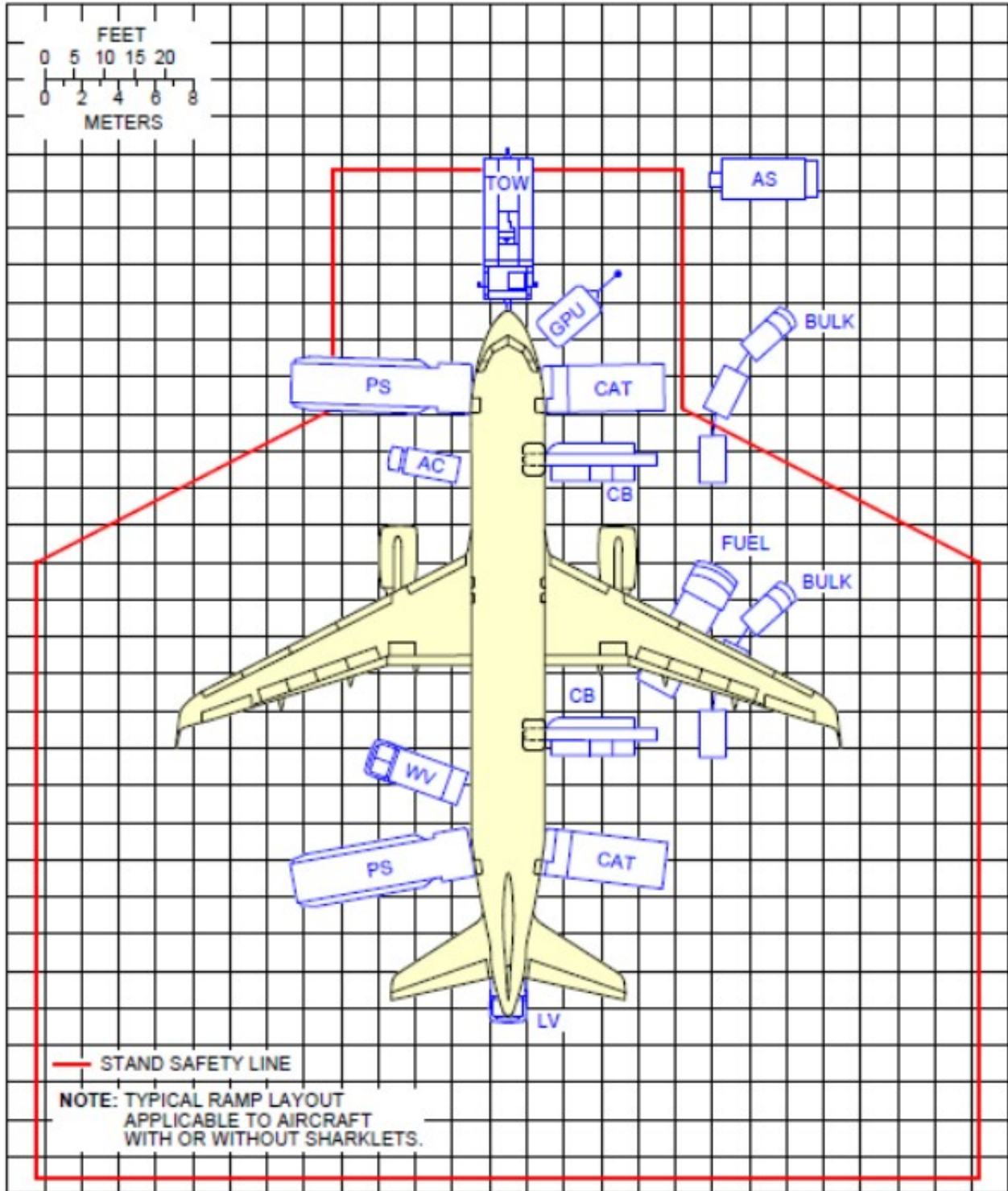

N_AC_050102_1_0030101_01_03

 ITA AIRWAYS Volume II HLM	INFORMATION PER AIRCRAFT TYPE	5.5	Page 21
	A320/200 - A320 neo - ITA	Ed 2 Rev 2/26 jan 23	

5.5.10 TOILETTE DRAIN

Below, the description of operational procedures for draining, flushing and filling of the chemical precharge.

1. Open service panel access door.
2. Unlock drain valve using unlock lever.
3. Connect the waste drain hose coupling to panel drain nipple and assure that the hose is well connected
4. Turn drain handle to unlock and pull until is fully extended and lock.
5. While the tanks drain, feel the drain hose and make sure that all waste is draining out.

Note: If the draining is not performed correctly, inform a Company representative.

6. Connect water supply hose coupling to the flush nipple.
7. Flush the tank using 57 litres of chemical precharge, the pressure must not exceed 50 PSI.
8. Close drain handle valve.
9. Remove the waste drain hose coupling to panel drain nipple and leave the fitting cap opened.
10. Fill 10 litres of disinfectant precharge solution.

Note: In case of leakage of chemical precharge from drain valves, inform a Company representative.

11. Closed the valves drain cap and latch the service panel.

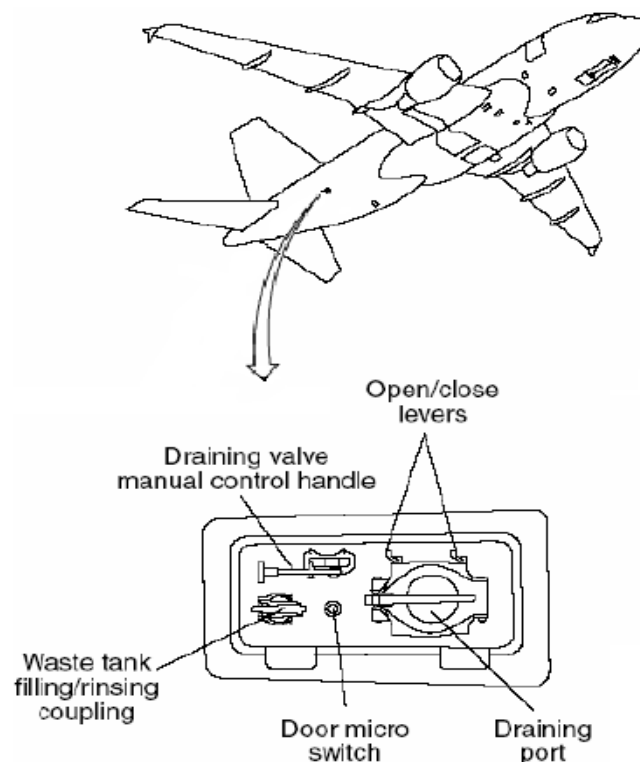

 ITA AIRWAYS Volume II HLM	INFORMATION PER AIRCRAFT TYPE	5.5	Page 22
	A320/200 - A320 neo - ITA	Ed 2 Rev 2/26 jan 23	

5.5.11 FILLING POTABLE WATER

The potable water supply on A320F aircraft provides a **maximum of 100 litres (1/2 level** on potable water quantity indicator in aft service panel).

The aircraft can be partially filled in AUTOMATIC mode only. When the aircraft is not electrically powered, the potable water quantity indicator in aft service panel does not work and so it is not possible to fill the tank partially (i.e. 1/2). If the automatic mode should be unavailable, the MANUAL mode (not electrically powered aircraft) requires to fill the tank completely (200 litres of water - FULL).

The filling procedure described below includes both options (AUTOMATIC and MANUAL)

AUTOMATIC (electrically powered aircraft)

1. Open the aft service panel access door.
2. Remove fill nipple cap.
3. Connect fill service hose.
4. Turn the handle for the fill valve (*Filling/Draining Selector*) from NORMAL position to PULL TO FILL position and pull.
5. Open potable water source valve; the water pressure must not exceed 50 PSI.

Note: On aft service panel “*Overflow Valve Open*” come on showing that the electrically powered overflow valve, in centre panel, is opened.

6. Turn the handle for the fill valve (*Filling/Draining Selector*) from PULL TO FILL position to NORMAL position when the needle of potable water quantity indicator has reached the 1/2 level.
7. Close water supply valve and remove the service hose.
8. Check that there’s no leakage of water from the fill valve.

Note: In case of leakage inform a Company representative.

9. Install cap on fill nipple
10. Close and latch the aft service panel access door.

MANUAL

1. Open the aft service panel access door.
2. Remove fill nipple cap.
3. Connect fill service hose.
4. Open the central service panel access door.
5. Central service panel: turn “*Tank Overflow*” handle from CLOSED position to OPEN position.
6. Aft service panel: turn the handle for the fill valve (*Filling/Draining Selector*) from NORMAL position to PULL TO FILL position and pull.
7. Open potable water source valve and refill until water flows from the “*Overflow Port*”; the water pressure must not exceed 50 PSI.
8. Aft service panel: turn the handle for the fill valve (*Filling/Draining Selector*) from PULL TO FILL position to NORMAL position.
9. Central service panel: turn “*Tank Overflow*” handle from OPEN position to CLOSED position.
10. Close and latch the central service panel access door.
11. Close water supply valve and remove the service hose.
12. Check that there’s no leakage of water from the fill valve.

Note: In case of leakage inform a company representative.

13. Install cap on fill nipple.
14. Close and latch the aft service panel access door.

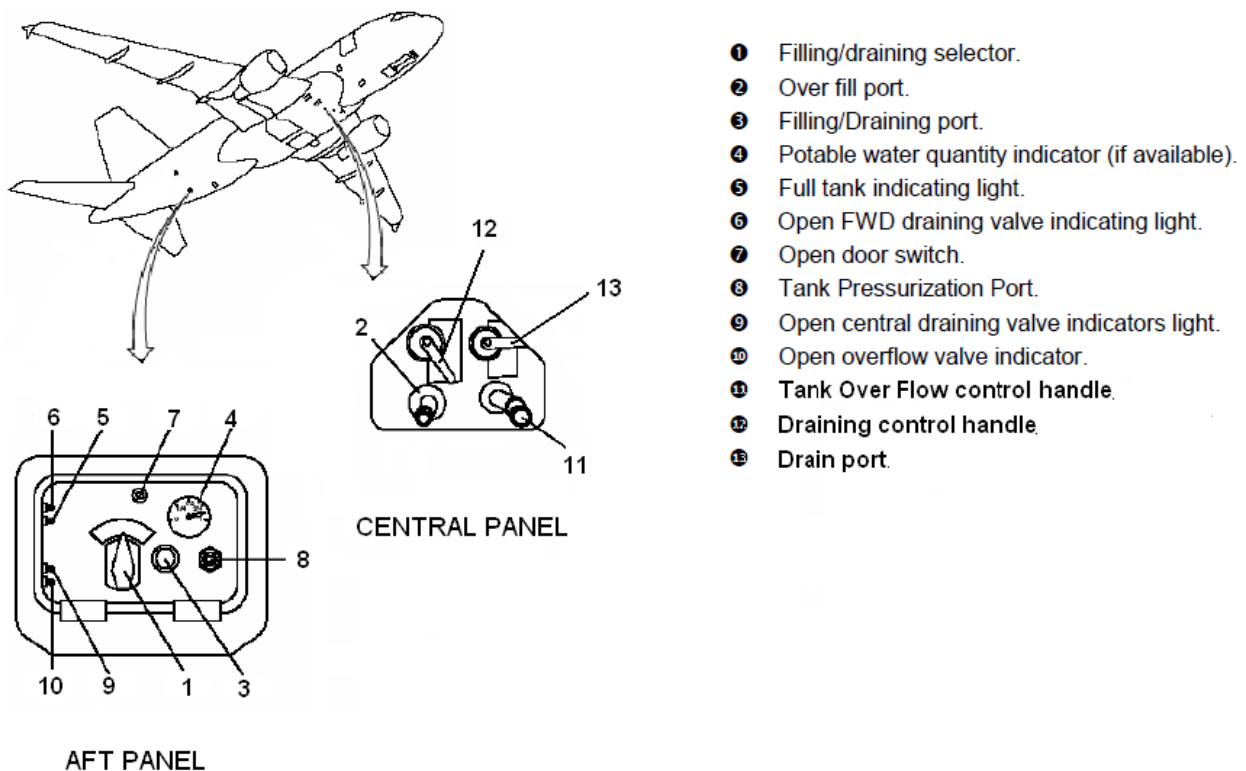

 ITA AIRWAYS Volume II HLM	INFORMATION PER AIRCRAFT TYPE	5.5	Page 24
	A320/200 - A320 neo - ITA	Ed 2 Rev 2/26 jan 23	

5.5.12 PRE DEPARTURE SERVICING CHECK LIST

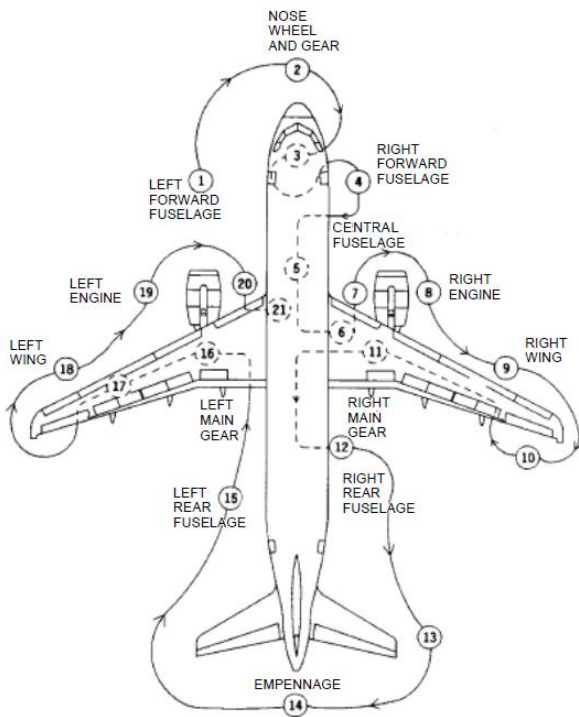

Predeparture Servicing Check List A320F		
N°	Aircraft section	Action (*)
1	left fwd fuselage	<i>condition</i>
	left fwd passengers door	<i>closed</i>
2	pitot-static tubes	<i>condition</i>
	static port	<i>clear</i>
	ground power access door	<i>closed</i>
	panel	<i>closed</i>
3	nose gear chocks (*)	<i>positioned</i>
	or	
	push back track	<i>connected</i>
	wheels and tires	<i>condition</i>
4	Hydraulic Safety Pin	<i>connected (push back) or removed (power out)</i>
	right fwd fuselage	<i>condition</i>
	right fwd passenger door	<i>closed and checked</i>
	right fwd cargo door	<i>closed and checked</i>
5	central fuselage	<i>condition</i>
	potable water access panel	<i>closed</i>
	LP e HP connection access	<i>closed</i>
	anticollision light (beacon)	<i>on</i>
6/9/10	right wing	<i>condition</i>
	fuel panel	<i>closed</i>
7/8	right wing	<i>condition</i>
11	landing gear chocks (*)	<i>removed</i>
	wheels and tires	<i>condition</i>
12	right rear fuselage	<i>condition</i>
	right rear cargo door	<i>closed and checked</i>
	right rear passenger door	<i>closed and checked</i>
	bulk door	<i>closed and checked</i>
	waste service panel	<i>closed</i>
13	empennage	<i>condition</i>
14	exhaust	<i>clear</i>
15	left rear fuselage	<i>condition</i>
	left rear passengers dor	<i>closed and checked</i>
	potable water panel	<i>closed</i>
16	left landing gear chocks (*)	<i>removed</i>
	wheels and tires	<i>condition</i>
17/18/21	left wing	<i>condition</i>
19/20	left engine	<i>condition</i>

(*)The term *condition* means that the following items have been verified: obvious damage, obvious liquid leakage and handles flush with the fuselage.

(**) the ground personnel must ensure that parking brakes have been set prior to removal

 ITA AIRWAYS Volume II HLM	INFORMATION PER AIRCRAFT TYPE	5.5	Page 25
	A320/200 - A320 neo - ITA	Ed 2 Rev 2/26 jan 23	

5.5.13 SAFETY AREAS

5.5.13.1 Idle thrust - Intake and Blast areas

The Intake and Blast areas at Idle thrust of the aircraft must be observed and no personnel and equipment must stay within these areas when the engines are operating.
 The Blast areas refer to the area behind the aircraft, starting from the aft end of operating engines.
 The safety distances shown in the table below must be observed.

IDLE THRUST (length of danger areas)		
- A - INTAKE AREA	- B - BLAST AREA	- C -
2.74 m	38.7 m	1.0 m

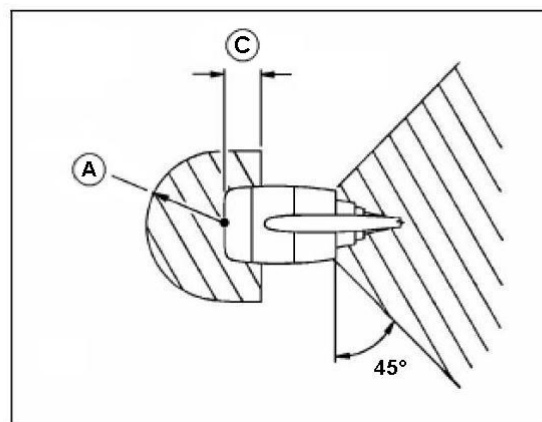
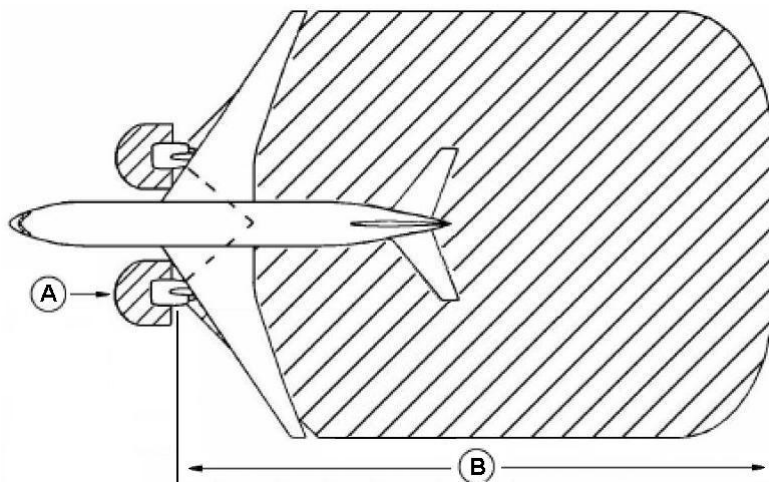

5.5.14 Steering limits

steering angle	R1 right main landing gear (RMLG)	R2 left main landing gear(LMLG)	R3 nose landing gear (NLG)	R4 wing		R5 nose	R6 tail
				wingtip	sharklet		
20	32.6 m	40.2 m	38.2 m	52.9 m	53.8 m	39.8 m	46 m
25	24.8 m	32.3 m	30.9 m	45.1 m	46 m	33 m	39 m
30	19.4 m	27 m	26.2 m	39.8 m	40.7 m	28.7 m	34.4 m
35	15.5 m	23.1 m	22.8 m	35.9 m	36.8 m	25.7 m	31.3 m
40	12.5 m	20.1 m	20.4 m	32.9 m	33.8 m	23.6 m	28.9 m
45	10.1 m	17.6 m	18.5 m	30.5 m	31.4 m	22.1 m	27.1 m
50	8 m	15.6 m	17.1 m	28.5 m	29.4 m	20.9 m	25.7 m
55	6.3 m	13.9 m	16 m	26.8 m	27.7 m	20.1 m	24.6 m
60	4.8 m	12.4 m	15.1 m	25.4 m	26.2 m	19.4 m	23.7 m
65	3.5 m	11.1 m	14.4 m	24.1 m	24.9 m	18.9 m	22.9 m
70	2.4 m	9.9 m	13.9 m	22.9 m	23.7 m	18.5 m	22.3 m
75 (MAX)	1.5 m	19 m	13.6 m	22 m	22.9 m	18.3 m	21.8 m

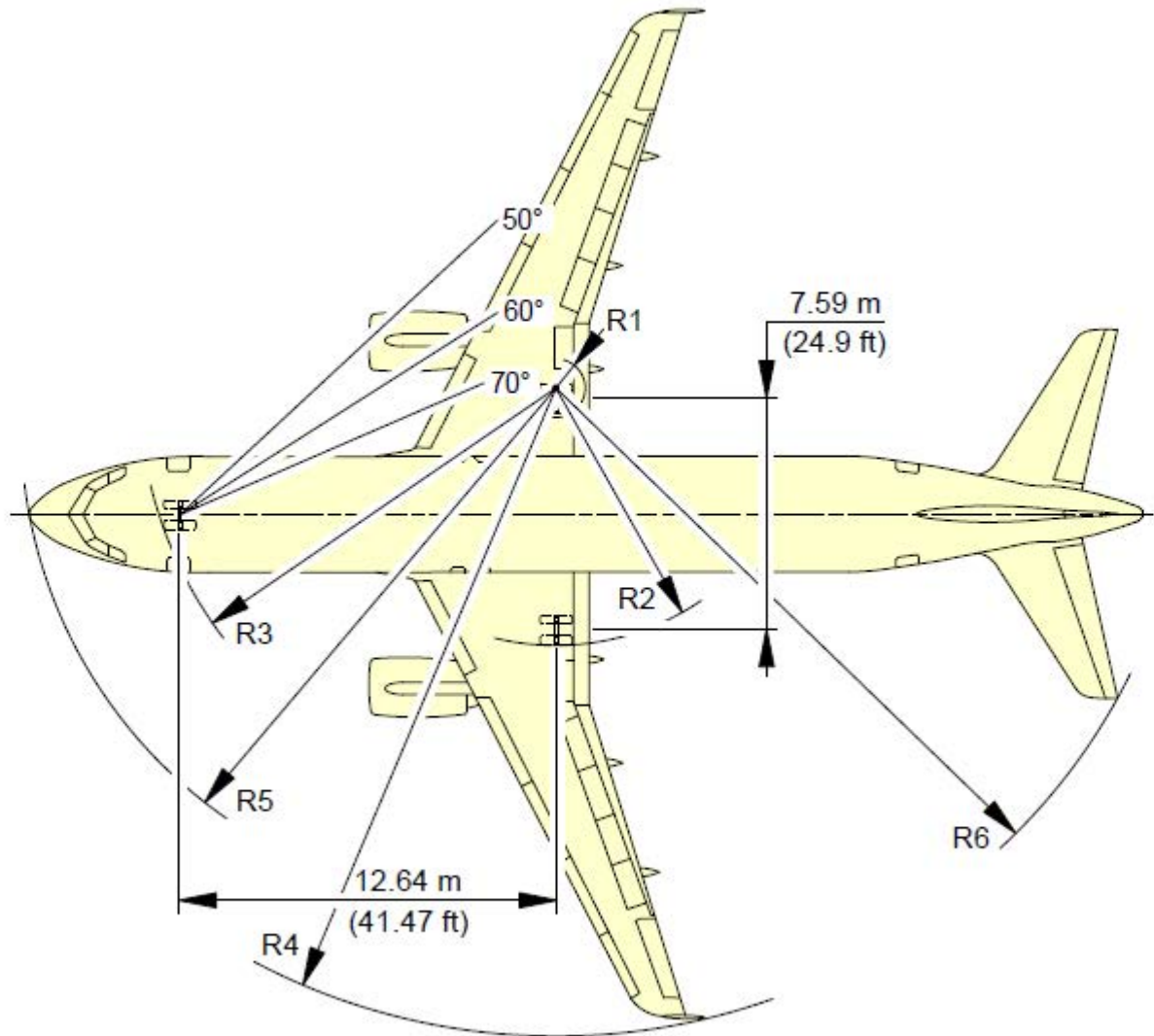

 Volume II HLM	INFORMATION PER AIRCRAFT TYPE	5.6	Page 1
	A319 - ITA	Ed 2/20 apr 2022	

5.6 A319 - ITA

5.6.1 HOLDS

5.6.1.1 Cargo compartment specifications

CARGO COMPARTMENT SPECIFICATIONS A-319	
MAX CARGO/BAGS CAPACITY	Kg 6.033
MAX CARGO/BAGS VOLUME	m ³ 26,8
FORWARD COMPARTMENTS 1	2 AKH CONTAINERS or 2 PKC PALLET in any INTERMIX
AFT COMPARTMENTS 4	2 AKH CONTAINERS or 2 PKC PALLET in any INTERMIX
COMPARTMENT 5	Kg 1.497 - Volume m ³ 7,2 - BULK LOAD

Compartments **1** and **4** are equipped to load **AKH** containers (whose capacity can reach up to 25 bags each approx.) or **PKC** pallets (specific for live animals or for coffins with human remains or generally speaking for those conventional shipments which are not compatible with an AKH container).

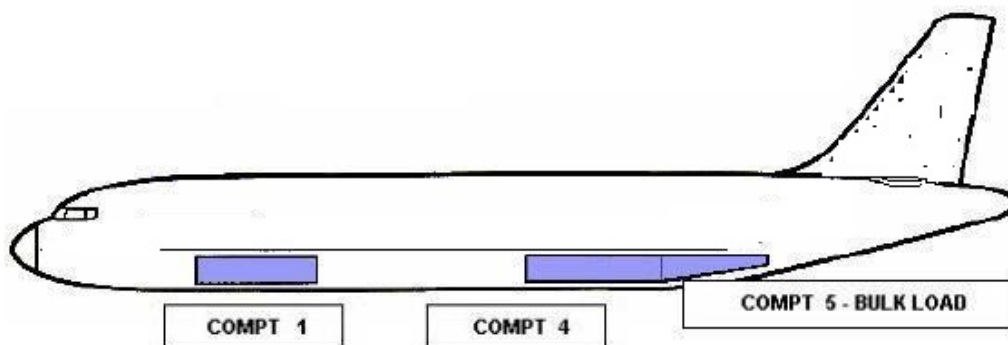

BULK LOAD IS FORBIDDEN IN COMPARTMENTS 1 - 4

The bays of compartment 1 are named 11 and 12, while the two bays of compartment 4 they are named respectively 41 and 42.

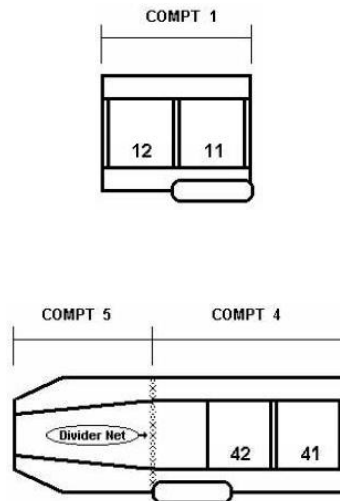

Each lock shall be always armed on empty ULD position (even if the hold is completely empty). The following table shows the loading sequence of ULD in each hold.

LOADING SEQUENCE OF ULDS					
	Forward Hold Positions			Aft Hold Positions	
	11	12		41	42
1 ULD	x		1 ULD		x
2 ULD	x	x	2 ULD	x	x

Intermix between forward and aft holds options is allowed.

For exemple, in case of loading of 2 ULDS on an aircraft, the possible configurations are:

- a. 2 ULDS on forward hold (positions 11 -12),
- b. 1 ULD on forward hold + 1 ULD on aft hold (positions 11 - 42),
- c. 2 ULDS on aft hold (positions 41 - 42).

 Volume II HLM	INFORMATION PER AIRCRAFT TYPE	5.6	Page 3
	A319 - ITA	Ed 2/20 apr 2022	

Compartment 5 is reserved for bulk loads. When the aircraft is not equipped with the cargo door specific to this hold, loading is carried out through compartment 4, more precisely from position 42: the compartments are separated by a net which must be **INSTALLED AND WORKING**, otherwise compartment 5 cannot be used, unless **ALL ITEMS ARE INDIVIDUALLY TIED-DOWN TO THE COMPARTMENT FLOOR**.

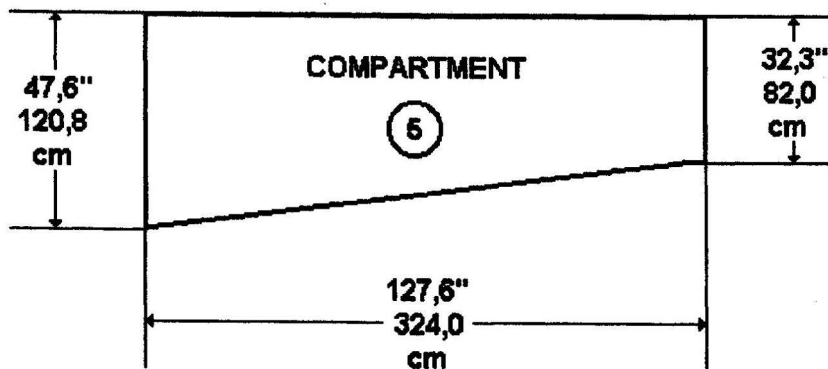
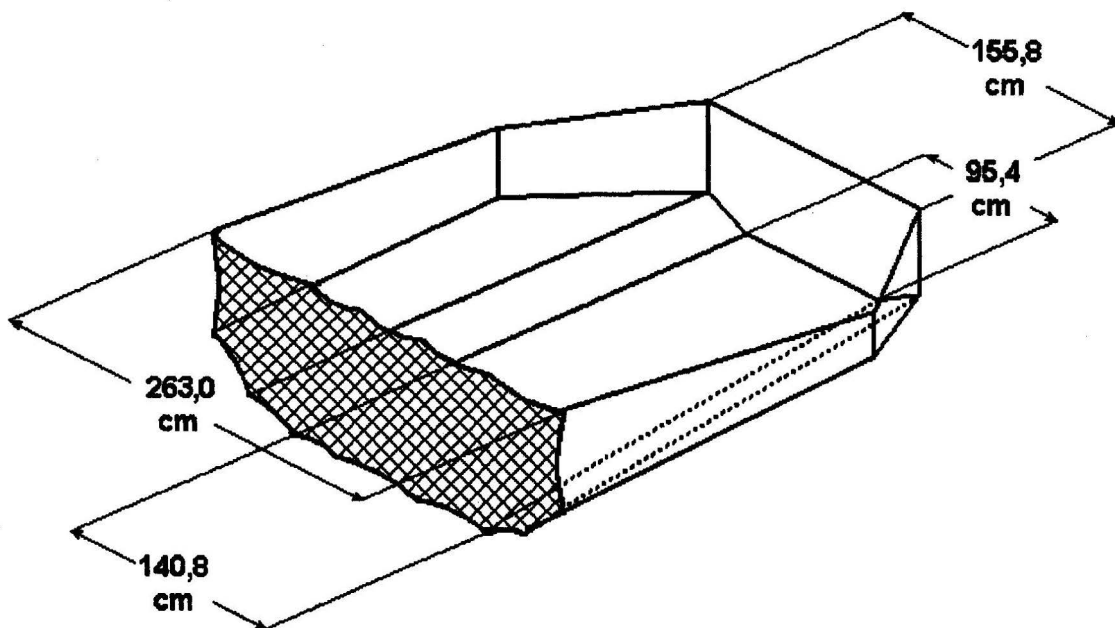

 ITA AIRWAYS Volume II HLM	INFORMATION PER AIRCRAFT TYPE	5.6	Page 4
	A319 - ITA	Ed 2 Rev 17/27 jan 26	



Due to fire extinguishing system feature, shipments containing Dangerous Goods (DG) as flammable and combustibles (class 2.1, 3 and 4) shall be loaded necessarily in the compartments 1 or 5. Segregation criteria shall be always respected (i.e. in case of DG class 2.1, 3 and 4, lithium-ion, lithium metal and sodium-ion batteries shall be loaded exclusively in the compartment 4).

COMPARTMENT	SURFACE RESISTANCE (Kg/m ²)	USABLE VOLUME (m ³)	MAX STRUCRAL LOAD (Kg)
1	488	7,36	2.268
4		7,36	2.268
5	732	7,22	1.497

Note: Maximum structural loads include the ULD tare weight.

Compartments **1-4** are equipped with a Cargo Handling System for the loading/unloading of ULDs and are certified even for transportation of non-certified ULD.

Cargo holds are pressurized and have the following systems installed:

- smoke detection system,
- fire extinguishing system,
- ventilation system (compartments 4 - 5).

MAXIMUM ULD LOAD PER POSITION (Kg)
ULD base dimensions (inches)
60.4 x 61.5 (AKH-PKC)
1.134

5.6.2 CLS malfunction

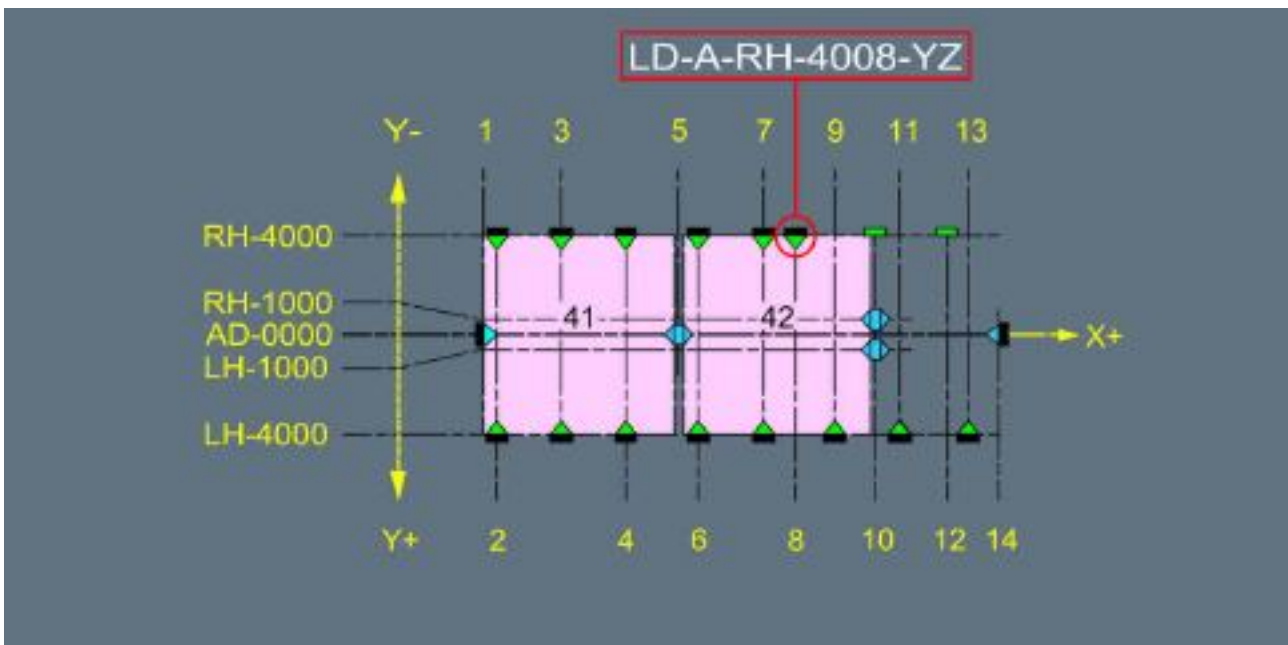
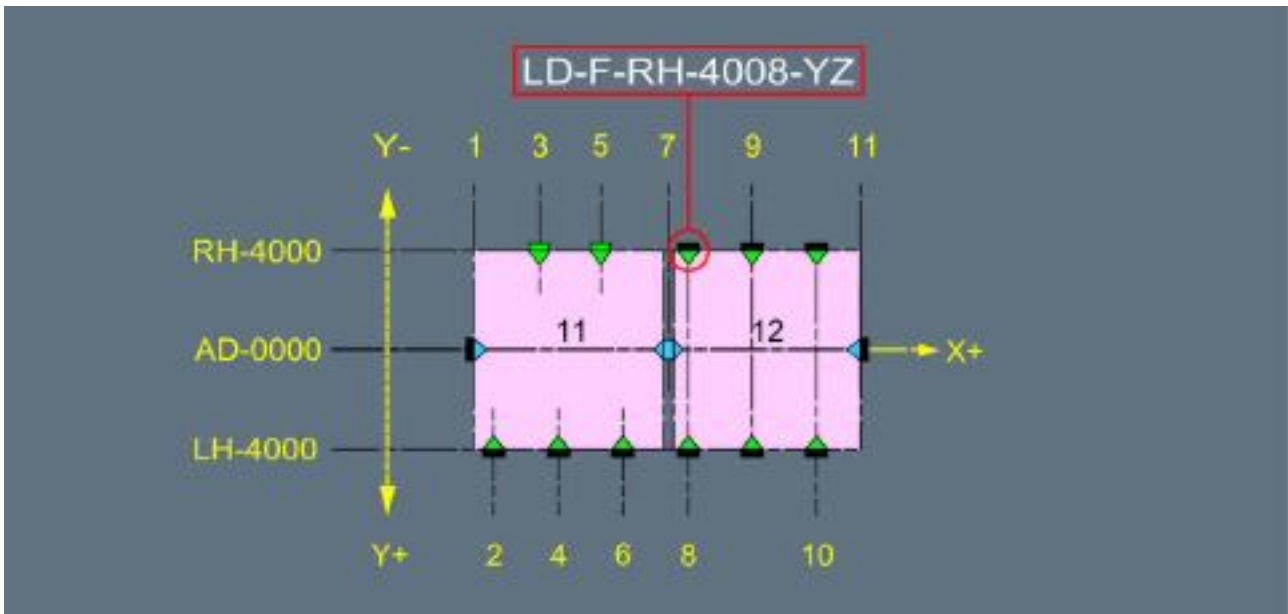

Latch type	position	latch code	failed latch per position	required conditions
XZ - single latch	11, 12	LD-F-AD-0007-XZ	1 latch	ULD removed
YZ- latch	11	LD-F-LH-4002-YZ	1 latch	ULD empty
		LD-F-LH-4004-YZ LD-F-LH-4006-YZ	2 or more latches	ULD removed
	12	LD-F-RH-4008-YZ LD-F-LH-4008-YZ	1 latch	ULD empty
		LD-F-RH-4009-YZ LD-F-LH-4009-YZ LD-F-RH-4010-YZ LD-F-LH-4010-YZ	2 or more latches	ULD removed
YZ- latch (door sill)	11	LD-F-RH-4003-YZ LD-F-RH-4005-YZ	1 or more latches	ULD removed
XZ - single latch	11, 12	LD-F-AD-0007-XZ	1 latch	ULD removed
	12,13	LD-F-AD-0011-XZ	1 latch	ULD removed
XZ - single latch	41, 42	LD-1-AD-0005-XZ	1 latch	ULD removed
	42	LD-A-RH-1010-XZ LD-A-LH-1010-XZ	1 latch	ULD empty
				2 or more latches
YZ - latch	41	LD-A-RH-4002-YZ LD-A-LH-4002-YZ	1 latch	ULD empty
		LD-A-RH-4003-YZ LD-A-LH-4003-YZ LD-A-RH-4004-YZ LD-A-LH-4004-YZ	2 or more latches	ULD removed
	42	LD-A-RH-4006-YZ LD-A-LH-4006-YZ	1 latch	ULD empty
		LD-A-RH-4007-YZ LD-A-LH-4007-YZ LD-A-RH-4008-YZ LD-A-LH-4009-YZ	2 or more latches	ULD removed
	-	LD-A-LH-4011-YZ LD-A-LH-4013-YZ	-	ULD empty
Y - latch (door sill)	41, 42	LD-A-AD-0001-XZ	1 latch	ULD removed
	-	LD-A-AD-0014-XZ	-	ULD empty
For one applicable position, the failed latches are of different types				ULD removed

 Volume II HLM	INFORMATION PER AIRCRAFT TYPE	5.6	Page 7
	A319 - ITA	Ed 2 Rev 2/26 jan 23	

Legenda:

- LD - Lower Deck**
- F - Forward Hold**
- A - Aft Hold**
- RH - Right hand Side**
- LH - Left hand Side**
- AD - Aircraft Datum**

 Volume II HLM	INFORMATION PER AIRCRAFT TYPE	5.6	Page 8
	A319 - ITA	Ed 2/20 apr 2022	

5.6.2.1 Cargo compartment temperature and ventilation

The following table shows all necessary information for the transportation of goods that need specific temperature and ventilation onboard this kind of aircraft.

COMPARTMENT	TEMPERATURE RANGE	VENTILATION	GROUND CONTROL	COCKPIT CONTROL
1	2°C - 4°C	NO	NO	NO
4	5°C - 26°C	YES	NO	YES
5	5°C - 26°C	YES	NO	YES

5.6.2.2 Resistance of fittings

All compartments can host single tie-down fittings for the restraint of bulk loads.

In compartments **1** and **4** they are located on the floor, while in compartment **5** they are on the floor, along the sides and on the ceiling.

The following table shows the fittings minimum resistance in every direction.

COMPARTMENT	MINIMUM RESISTANCE
1 - 4 - 5	2000 LB / 907 Kg

The resistance can be calculated by multiplying the fittings resistance by the coefficient related to the angle (9.3.3 "LOAD RESTRAINT FACTORS").

DIRECTION	COMPARTMENT	RESTRAINT FACTOR
FORWARD	ALL	1,49 G
BACKWARD	ALL	1,37 G
RIGHT - LEFT	1	0,77 G
	4	1,56 G
	5	1,80 G
UPWARD	1	2,05 G
	4	2,78 G
	5	3,12 G

 Volume II HLM	INFORMATION PER AIRCRAFT TYPE	5.6	Page 9
	A319 - ITA	Ed 2/20 apr 2022	

5.6.2.3 Forward and aft cargo door maximum dimensions

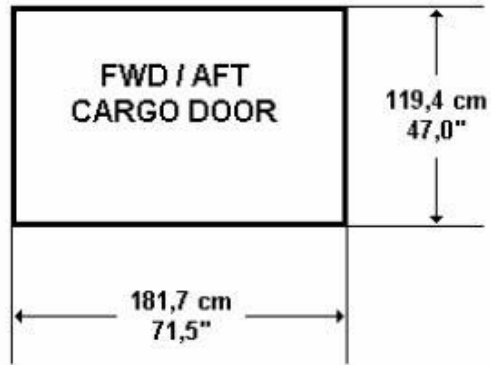

 Volume II HLM	INFORMATION PER AIRCRAFT TYPE	5.6	Page 10
	A319 - ITA	Ed 2/20 apr 2022	

5.6.2.4 Maximum dimensions for conventional load in compartment 5

MAXIMUM DIMENSIONS FOR CONVENTIONAL LOADS IN COMPARTMENT 5 WITH UPRIGHT LOADING THROUGH COMPARTMENT 4 CARGO DOOR

WIDTH	HEIGHT		
	79,5 cm – 31,2"	106,5 cm – 41,9"	119 cm – 46,8"
10 cm	324 cm	324 cm	324 cm
3,9"	127,5"	127,5"	127,5"
20 cm	324 cm	324 cm	324 cm
7,8"	127,5"	127,5"	127,5"
30 cm	324 cm	324 cm	324 cm
11,8"	127,5"	127,5"	127,5"
40 cm	324 cm	324 cm	324 cm
15,7"	127,5"	127,5"	127,5"
50 cm	324 cm	324 cm	324 cm
19,6"	127,5"	127,5"	127,5"
60 cm	324 cm	324 cm	304 cm
23,6"	127,5"	127,5"	119,6"
70 cm	324 cm	324 cm	284 cm
27,5"	127,5"	127,5"	111,8"
80 cm	324 cm	324 cm	264 cm
31,4"	127,5"	127,5"	103,9"
90 cm	324 cm	324 cm	244 cm
35,4"	127,5"	127,5"	96"
100 cm	324 cm	324 cm	224 cm
39,3"	127,5"	127,5"	88,1"
110 cm	324 cm	324 cm	204 cm
42,3"	127,5"	127,5"	80,3"
120 cm	324 cm	317 cm	184 cm
47,2"	127,5"	124,8"	72,4"
130 cm	324 cm	297 cm	164 cm
51,1"	127,5"	116,9"	64,5"
140 cm	324 cm	276 cm	144 cm
55,1"	127,5"	108,6"	56,6"
150 cm	310 cm	256 cm	
59"	122"	100,7"	
160 cm	288 cm	235 cm	
62,9"	113,3"	92,5"	
170 cm	265 cm	214 cm	
66,9"	104,3"	84,2"	
	LENGTH		

The maximum allowed weight for each item loaded in compartment 5 is 70 kg each

 Volume II HLM	INFORMATION PER AIRCRAFT TYPE	5.6	Page 11
	A319 - ITA	Ed 2/20 apr 2022	

The previous table shows maximum dimensions of the packages that don't need to be tilted for their loading, but if it's necessary, they must be lifted and positioned with the one end of them on the sloping part of the floor (provided that the packages do not have a rigid structure) and the other end on the horizontal floor, as shown in the following image of compartment 5.

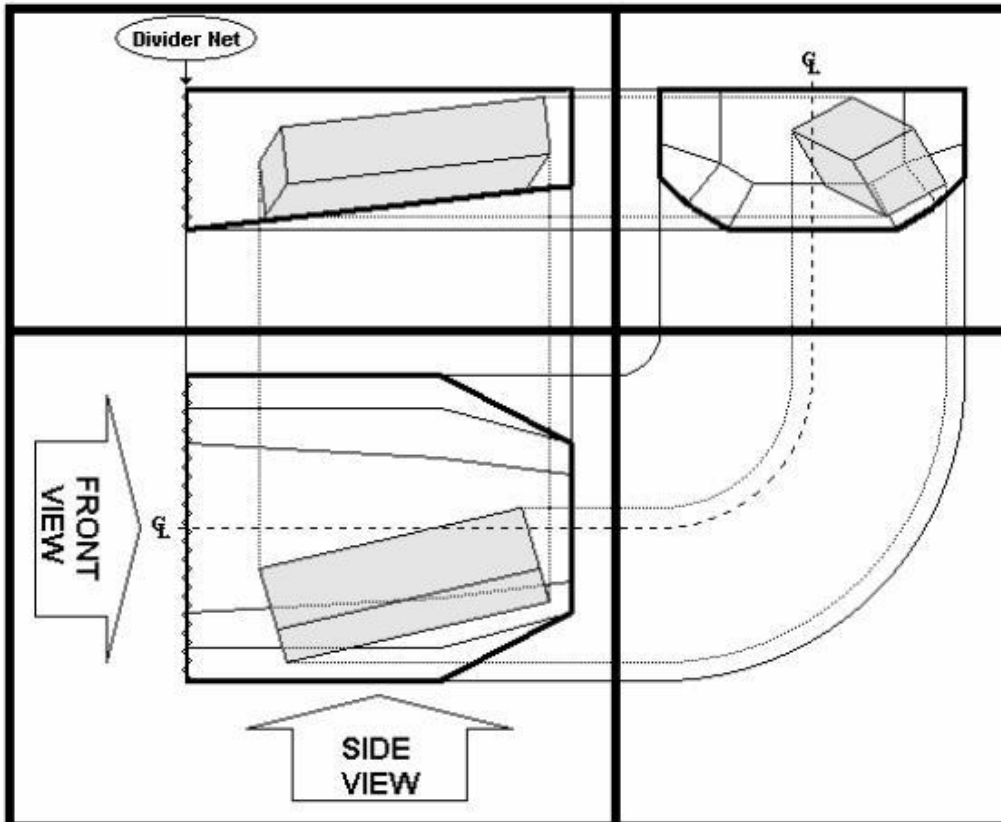

 Volume II HLM	INFORMATION PER AIRCRAFT TYPE	5.6	Page 12
	A319 - ITA	Ed 2/20 apr 2022	

5.6.3 LOADING PROCEDURE FOR A319 CONTAINERIZED A/C IN STATIONS WITHOUT SUITABLE LOADER

In order to guarantee the operations in stations without suitable loader to handle a A319 containerized, it is mandatory to follow some instructions on how to load/unload holds.

In station without suitable loader, AKH containers and PKC pallets shall not be offloaded. Baggage offloading will be done totally manually or with the support of a conveyor belt.

Loading of baggage in holds must be performed in order to not allow subsequent stations, during loading/offloading operations, to remove transit baggage.

From departing stations and/or transit stations a full fit configuration is required as follows:

- 2 AKH containers in 12 and 41 positions.
- 2 PKC pallets with appropriate nets in 11 and 42 positions.

All containers must be loaded with the opening facing the hold doors, in order to allow baggage handling in the hold.

Person in charge for planning and issuing the “loading instructions” and the loading Supervisor shall verify that what expected on board, in weight, dimensions and volume terms, is compatible with the current procedure and with the type of aircraft used. In case of irregularities, the Station Manager or its delegate shall be informed promptly.

Station Manager or its delegate shall verify that the current procedure is alligned with local regulation and legislation.

 Volume II HLM	INFORMATION PER AIRCRAFT TYPE	5.6	Page 13
	A319 - ITA	Ed 2 Rev 14/05 jun 25	

5.6.3.1 Cross section of compartments 1-4 - internal dimensions for the loading of conventional loads

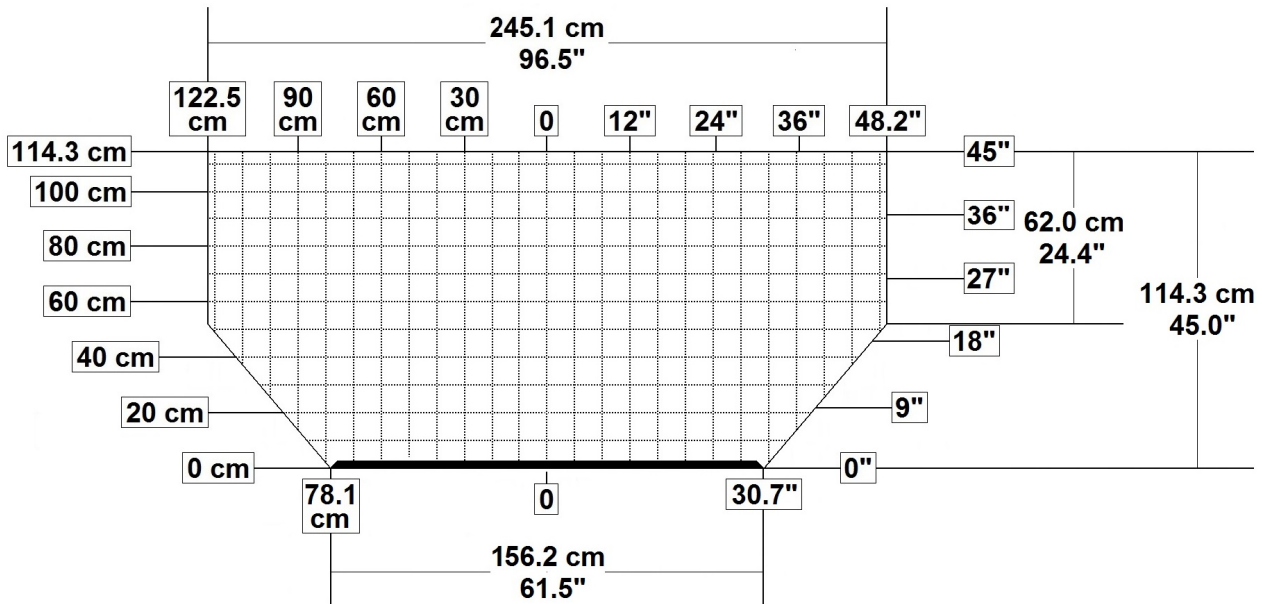

Notes:

- the side of each square is 10 cm (4,0") long,
- those given are the maximum dimensions: pallets must be built up in such a way as to keep the 5 cm / 2" minimum clearance from ceiling lights, smoke detectors and compartment contour,
- the pallet is about 2,5 cm (1") thick, and should be subtracted from the available height.

The pallets maximum height shall not exceed 114.3 cm / 45"

Overhangs on short sides of pallet based 60.4"x61.5" are allowed

Overhangs on long side (61.5") of pallet based 60.4"x61.5" are allowed up to 3.1" (8 cm) provided that the overhang is not positioned next front / rear bulkheads and that a related obliged clearance is built in the adjoining pallet, if necessary

 Volume II HLM	INFORMATION PER AIRCRAFT TYPE	5.6	Page 14
	A319 - ITA	Ed 2 Rev 2/26 jan 23	

5.6.4 FUEL

The A-319 has three tanks: one centre tank and two wing tanks. The following table shows their capacity in kg. as to weight and in litres as to volume.

	WEIGHT Kg	VOLUME Lt
LEFT WING TANK	6127	7805
RIGHT WING TANK	6127	7805
CENTER TANK	6476	8250
TOTAL	18730	23860

To determine the influence of fuel loading on the aircraft's centre of gravity, use the fuel pattern diagram on the back page of the balance chart form, as shown below, paying attention to the following alert:

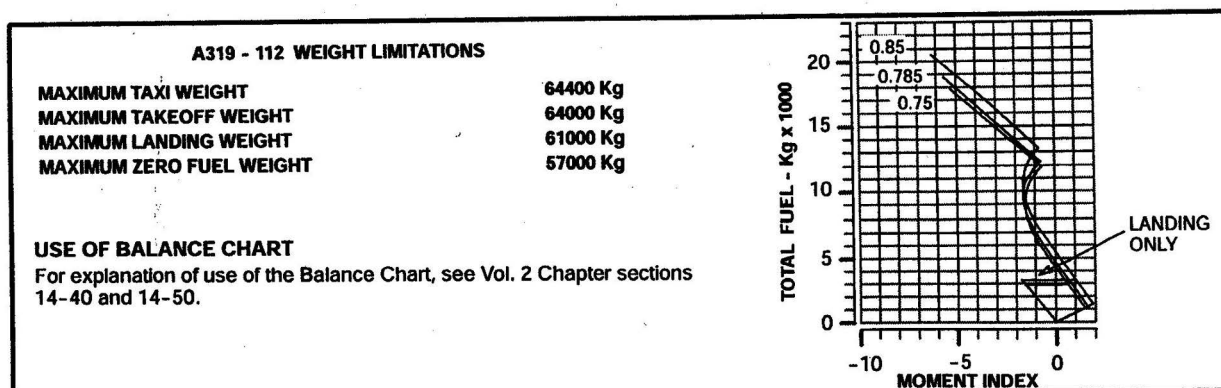

As evidenced by the fuel pattern above, the trip curve shows an anomaly, as it is significantly different from the fuel loading curve, during the descent and landing phases; due to this anomaly, when fuel burning reaches about 3.000kg from Zero Fuel, the center of gravity of the aircraft moves dramatically and significantly towards left side, for **just less than 3 moment index**, and then comes to align again over the loading curve.

The DCS automated system is able to evaluate this anomaly by limiting the C.G. excursion range area at Zero; while, in case of manual elaboration of the balance chart, the following rule shall absolutely be applied:

IN CASE OF NOSE DOWN BALANCE CONDITIONS, THE C.G. AT ZFW SHALL BE AT LEAST 3 M.I. TO THE RIGHT OF THE FORWARD OPERATIVE LIMIT!

 Volume II HLM	INFORMATION PER AIRCRAFT TYPE	5.6	Page 15
	A319 - ITA	Ed 2 Rev 2/26 jan 23	

5.6.5 LOAD LIMITATIONS

5.6.5.1 Shear and bending moment limitations

Shear load and bending moment are internal forces, induced in a structure, while external forces stress the same structure.

External forces induce structural stress such as:

- shearing stress
- bending moment

They increase their value from zero (wing tip) up to the maximum corresponding to the zone where the wing root connects to the fuselage.

The section involved in the check is bounded by the wing connection root of the fuselage.

The stress induced in aircraft section just described, beside the weight of the affected fuselage section, depends on:

- payload
- centre of gravity position in zero fuel weight condition.

ITA has developed a “load limitation form” to verify accordance to the shear load and bending moment limits, manually, by using the back side of A320 Family aircraft balance chart form.

The procedure for shear load and bending moment must be applied when the following conditions take place at the same time:

- Actual Zero Fuel Weight (AZFW) coinciding to Maximum Zero Fuel Weight (MZFW)
- At least one ULD exceeds the gross weight of 700 Kg

Besides the common structural limitations for individual bay, easily summed up in 1.134 Kg for each containerised position and 1.497 Kg for compartment 5, on the back side of the balance chart there is a calculation table for control of limitations regarding the bending effect of weight on the aircraft structure flexibility between forward and aft.

The following method must be applied:

- Enter the weight and bending index related to the number of passengers in the boxes corresponding to passengers in each area (except for the 0b area, not involved as being so close to the main gear): interpolation is not allowed, therefore, the highest value must be considered.
- Enter the actual weight and bending index of each bay in the corresponding boxes: interpolation is not allowed, so take the higher value (i.e. for an empty AKH container use the bending index related to 82 kg).
- Sum the weight and bending indexes of the forward and aft areas, thus obtaining two pair of results.
- Enter the % MAC value related to ZFW
- Check the structural limits, both forward and aft, related to the actual %MAC at ZFW to make sure that they are higher than the values resulted from the sum: if this does not happen, then load distribution must be changed in order to fall within the limitations.

 Volume II HLM	INFORMATION PER AIRCRAFT TYPE	5.6	Page 16
	A319 - ITA	Ed 2/20 apr 2022	

5.6.6 USE OF MARKER CONES

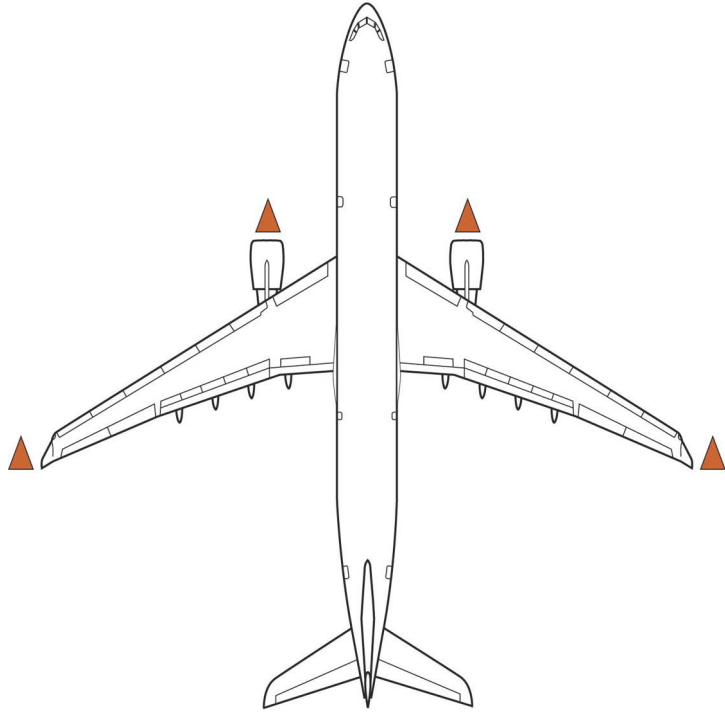

5.6.7 CHOCKING OF AIRCRAFT

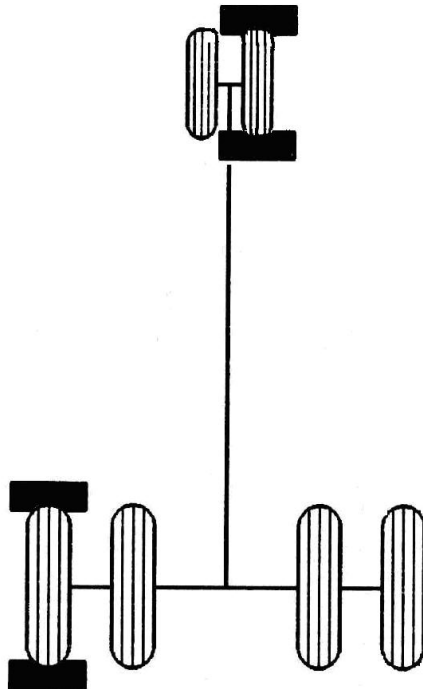

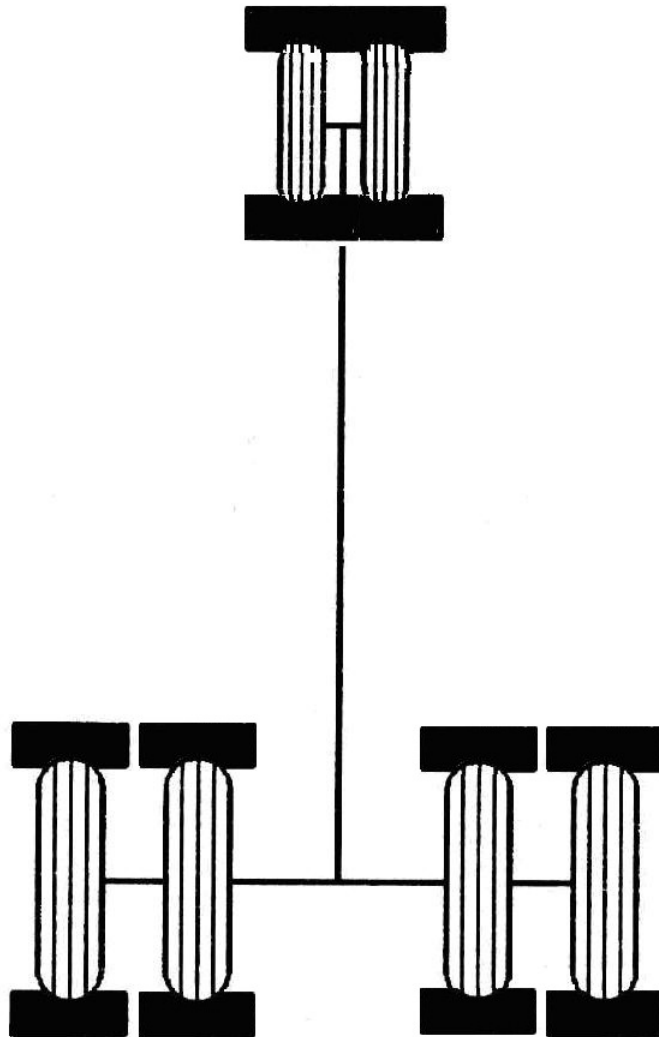

 Volume II HLM	INFORMATION PER AIRCRAFT TYPE	5.6	Page 17
	A319 - ITA	Ed 2/20 apr 2022	

5.6.8 Chocking of aircraft with wind over 25kt (46.3 km/h)

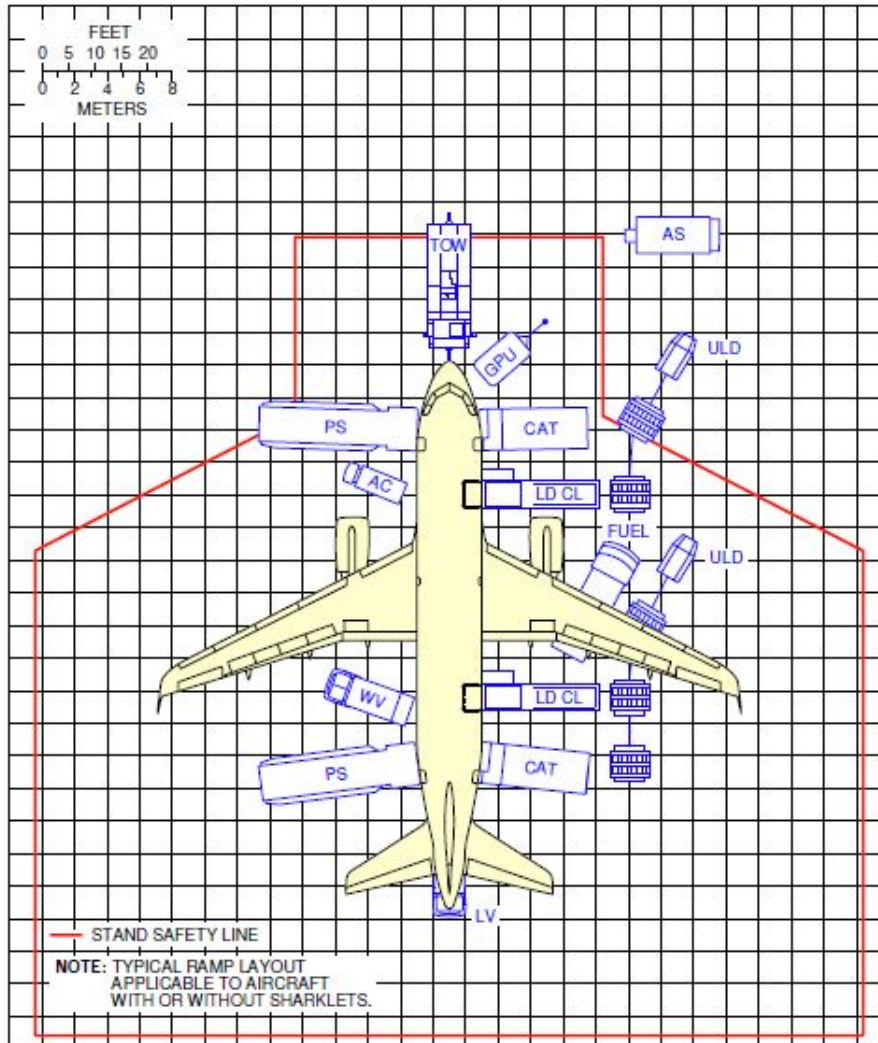

5.6.9 SERVICING ARRANGEMENTS



 Volume II HLM	INFORMATION PER AIRCRAFT TYPE	5.6	Page 19
	A319 - ITA	Ed 2/20 apr 2022	

5.6.10 TOILETTE DRAIN

Below, the description of operational procedures for draining, flushing and filling of the chemical precharge.

1. Open service panel access door.
2. Unlock drain valve using unlock lever.
3. Connect the waste drain hose coupling to panel drain nipple and assure that the hose is well connected
4. Turn drain handle to unlock and pull until is fully extended and lock.
5. While the tanks drain, feel the drain hose and make sure that all waste is draining out.

Note: If the draining is not performed correctly, inform a Company representative.

6. Connect water supply hose coupling to the flush nipple.
7. Flush the tank using 25 litres of chemical precharge, the pressure must not exceed 50 PSI.
8. Close drain handle valve.
9. Remove the waste drain hose coupling to panel drain nipple and leave the fitting cap opened.
10. Fill 10 litres of disinfectant precharge solution.

Note: In case of leakage of chemical precharge from drain valves, inform a Company representative.

11. Closed the valves drain cap and latch the service panel.

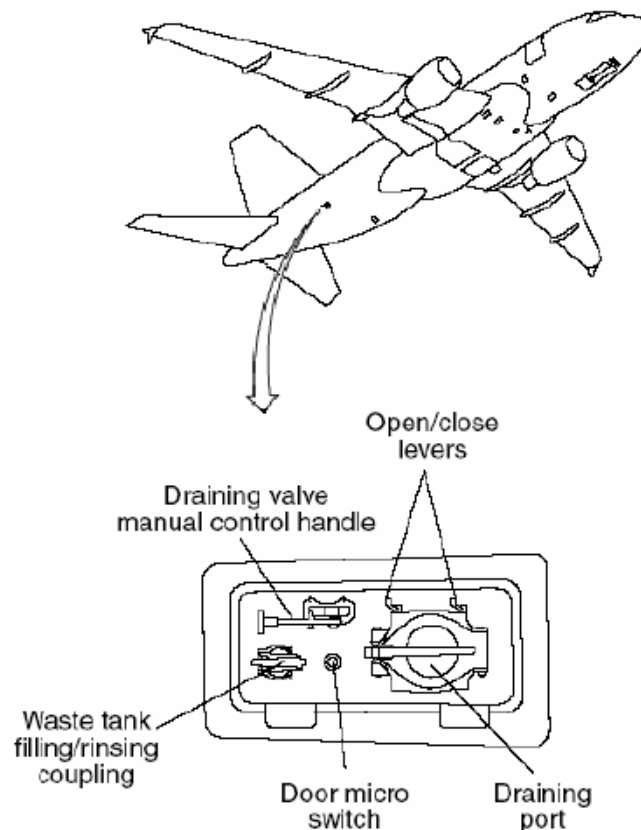

 Volume II HLM	INFORMATION PER AIRCRAFT TYPE	5.6	Page 20
	A319 - ITA	Ed 2/20 apr 2022	

5.6.11 FILLING POTABLE WATER

The potable water supply on A320F aircraft provides a **maximum of 100 litres (1/2 level** on potable water quantity indicator in aft service panel).

The aircraft can be partially filled in AUTOMATIC mode only. When the aircraft is not electrically powered, the potable water quantity indicator in aft service panel does not work and so it is not possible to fill the tank partially (i.e. 1/2). If the automatic mode should be unavailable, the MANUAL mode (not electrically powered aircraft) requires to fill the tank completely (200 litres of water - FULL).

Below, the description of operational procedures for filling potable water.

AUTOMATIC (electrically powered aircraft).

1. Open the service panel access door.
2. Remove fill nipple cap.
3. Connect fill service hose.
4. Turn the handle for the fill valve (*Filling/Draining Selector*) from NORMAL position to PULL TO FILL position and pull.
5. Open potable water source valve; the water pressure must not exceed 50 PSI.
6. Turn the handle for the fill valve (*Filling/Draining Selector*) from PULL TO FILL position to NORMAL position when the needle of potable water quantity indicator has reached the 1/2 level.
7. Close water supply valve and remove the service hose.
8. Check that there's no leakage from the fill valve.

Note: In case of leakage inform a Company representative.

9. Install cap on fill nipple.
10. Close and latch the service panel.

MANUAL

1. Open the service panel access door.
2. Remove fill nipple cap.
3. Connect fill service hose.
4. Turn the handle for the fill valve (*Filling/Draining Selector*) from NORMAL position to PULL TO FILL position and pull.
5. Open potable water source valve and refill until water flows from the "*Overflow Port*"; the water pressure must not exceed 50 PSI.
6. Turn the handle for the fill valve (*Filling/Draining Selector*) from PULL TO FILL position to NORMAL position.
7. Stop the procedure to fill the water tank when water flows from the "*Overflow Port*".
8. Manually return the fill valve "*Fill/Draining Selector Valve*" to NORMAL position.
9. Close water supply valve and remove the service hose.
10. Check that there's no leakage of water from the fill valve.

Note: In case of leakage inform a Company representative.

11. Install cap on fill nipple.
12. Close and latch the service panel.

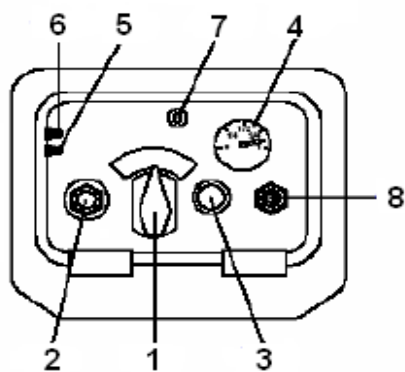
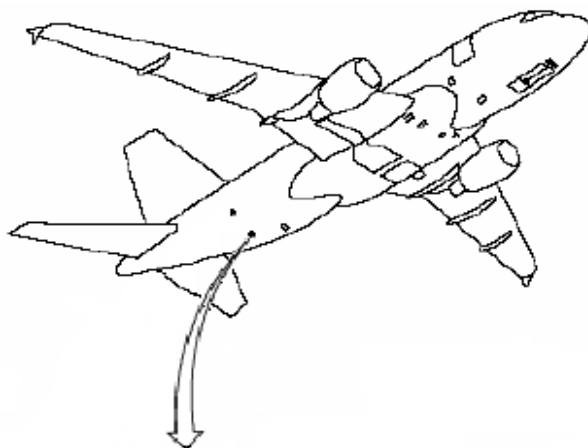

- ❶ Filling/drainage selector.
- ❷ Over fill port.
- ❸ Filling/Drainage port.
- ❹ Potable water quantity indicator (if available).
- ❺ Full tank indicating light.
- ❻ Open FWD draining valve indicating light.
- ❼ Open door switch.
- ❽ Tank Pressurization Port.

AFT PANEL

 ITA AIRWAYS Volume II HLM	INFORMATION PER AIRCRAFT TYPE	5.6	Page 22
	A319 - ITA	Ed 2/20 apr 2022	

5.6.12 PRE DEPARTURE SERVICING CHECK LIST

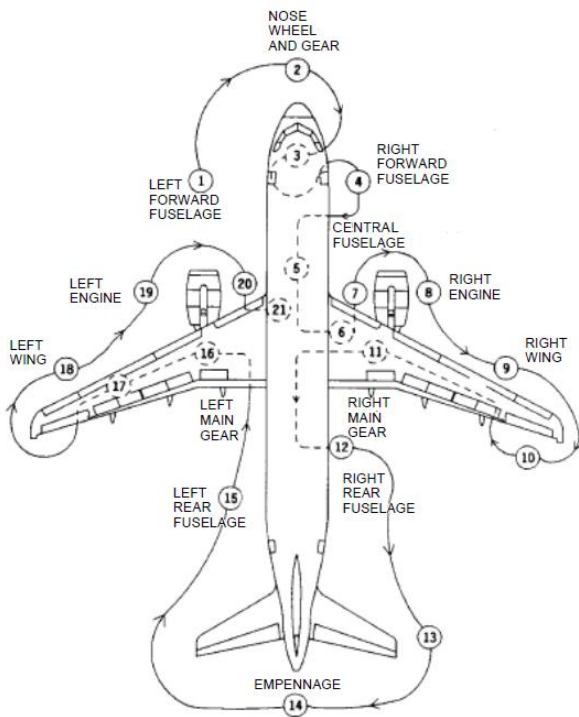

Predeparture Servicing Check List A320F		
N°	Aircraft section	Action (*)
1	left fwd fuselage	<i>condition</i>
	left fwd passengers door	<i>closed</i>
2	pitot-static tubes	<i>condition</i>
	static port	<i>clear</i>
	ground power access door panel	<i>closed</i>
3	nose gear chocks (**)	<i>positioned</i>
	or	
	push back track wheels and tires	<i>connected</i>
	Hydraulic Safety Pin	<i>connected (push back) or removed (power out)</i>
4	right fwd fuselage	<i>condition</i>
	right fwd passenger door	<i>closed and checked</i>
	right fwd cargo door	<i>closed and checked</i>
5	central fuselage	<i>condition</i>
	potable water access panel	<i>closed</i>
	LP e HP connection access	<i>closed</i>
	anticollision light (beacon)	<i>on</i>
6/9/10	right wing	<i>condition</i>
	fuel panel	<i>closed</i>
7/8	right wing	<i>condition</i>
11	landing gear chocks (**)	<i>removed</i>
	wheels and tires	<i>condition</i>
12	right rear fuselage	<i>condition</i>
	right rear cargo door	<i>closed and checked</i>
	right rear passenger door	<i>closed and checked</i>
	bulk door	<i>closed and checked</i>
	waste service panel	<i>closed</i>
13	empennage	<i>condition</i>
14	exhaust	<i>clear</i>
15	left rear fuselage	<i>condition</i>
	left rear passengers dor	<i>closed and checked</i>
	potable water panel	<i>closed</i>
16	left landing gear chocks (**)	<i>removed</i>
	wheels and tires	<i>condition</i>
17/18/21	left wing	<i>condition</i>
19/20	left engine	<i>condition</i>

(*)The term *condition* means that the following items have been verified: obvious damage, obvious liquid leakage and handles flush with the fuselage.
 (**) the ground personnel must ensure that parking brakes have been set prior to removal

5.6.13 SAFETY AREAS

5.6.13.1 Idle thrust - Intake and Blast areas

The Intake and Blast areas at Idle thrust of the aircraft must be observed and no personnel and equipment must stay within these areas when the engines are operating.
 The Blast areas refer to the area behind the aircraft, starting from the aft end of operating engines.
 The safety distances shown in the table below must be observed.

IDLE THRUST (length of danger areas)		
- A - INTAKE AREA	- B - BLAST AREA	- C -
2.2 m	61.0 m	1.0 m

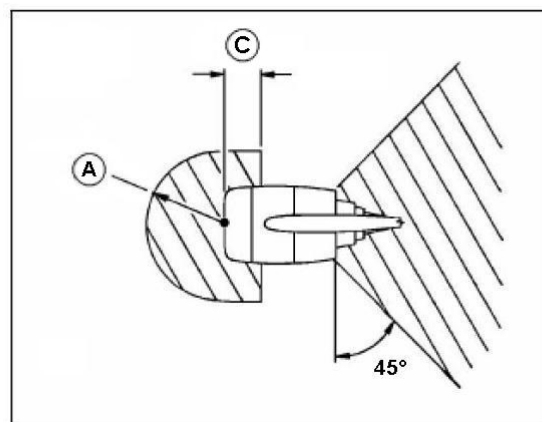
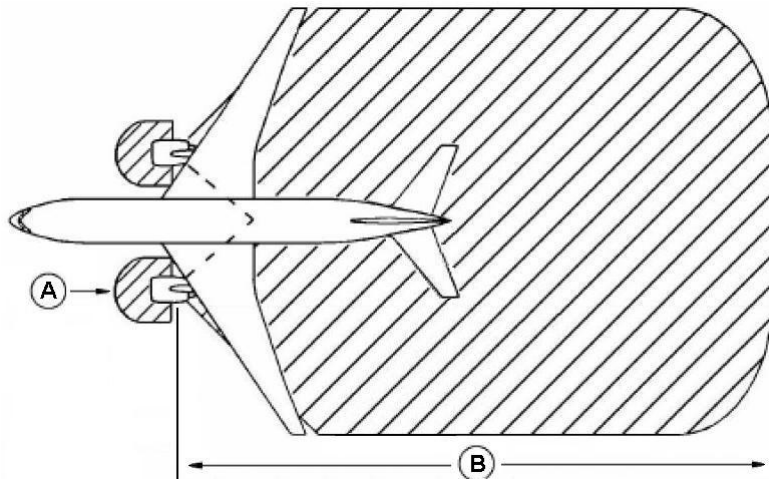

5.6.14 Steering limits

steering angle	R1 right main landing gear (RMLG)	R2 left main landing gear(LMLG)	R3 nose landing gear (NLG)	R4 wing		R5 nose	R6 tail
				wingtip	sharklet		
20	28.2 m	35.8 m	33.5 m	48.6 m	49.4 m	35.2 m	41.2 m
25	21.4 m	29 m	27.2 m	41.8 m	42.6 m	29.3 m	35.1 m
30	16.7 m	24.3 m	23 m	37.1 m	38 m	25.6 m	31.1 m
35	13.3 m	20.9 m	20.1 m	33.7 m	34.6 m	23 m	28.3 m
40	10.6 m	18.2 m	17.9 m	31.1 m	31.9 m	21.2 m	26.2 m
45	8.5 m	16.1 m	16.3 m	29 m	29.8 m	19.8 m	24.6 m
50	6.7 m	14.3 m	15 m	27.2 m	28 m	18.9 m	23.3 m
55	5.2 m	12.7 m	14 m	25.7 m	26.5 m	18.1 m	22.3 m
60	3.8 m	11.4 m	13.2 m	24.4 m	25.2 m	17.5 m	21.4 m
65	2.6 m	10.2 m	12.6 m	23.2 m	24 m	17.1 m	20.7 m
70	1.6 m	9.2 m	12.2 m	22.2 m	23 m	16.8 m	20.1 m
75 (MAX)	0.8 m	8.4 m	11.8 m	21.4 m	22.3 m	16.6 m	19.7 m

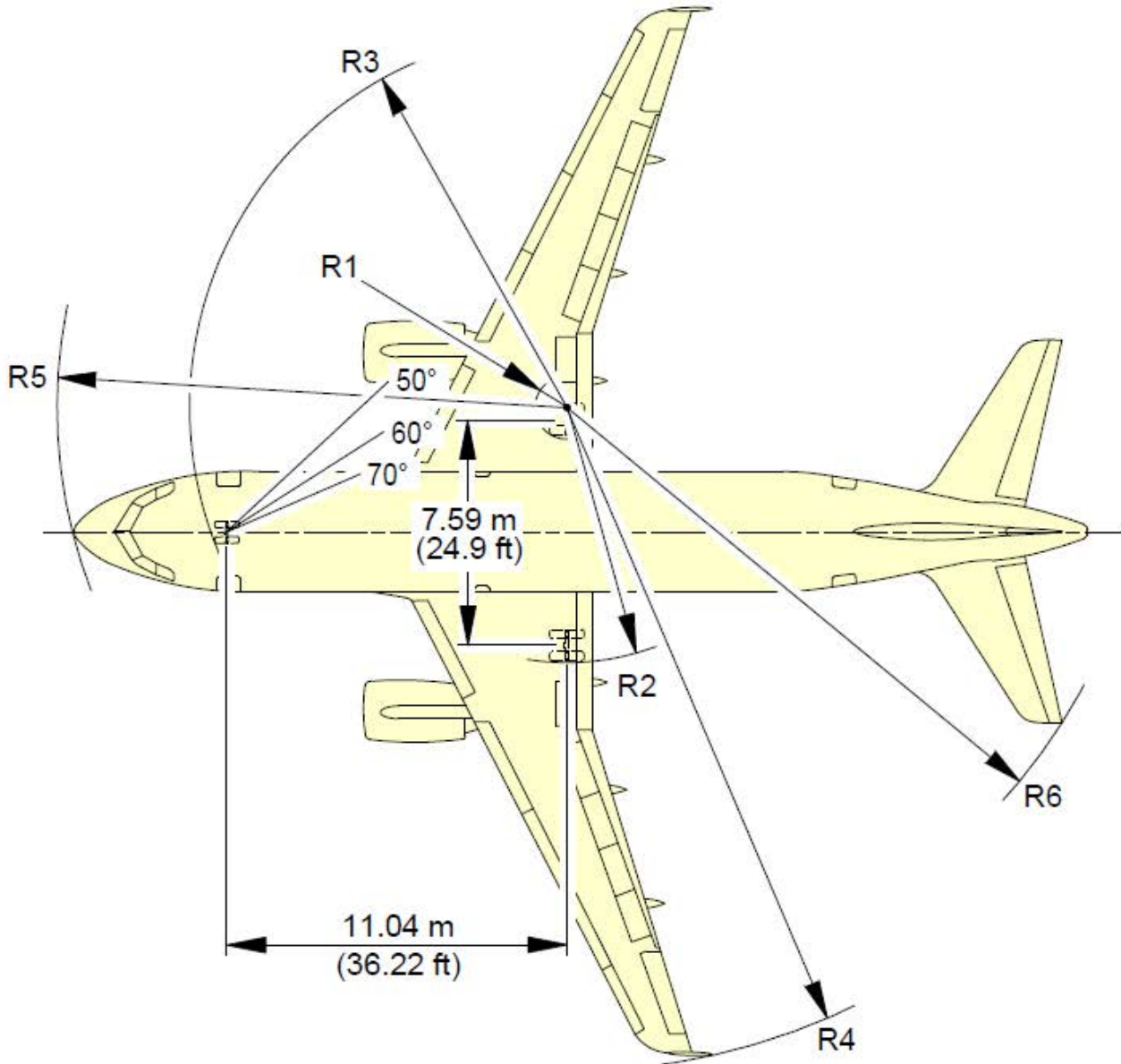

 ITA AIRWAYS Volume II HLM	INFORMATION PER AIRCRAFT TYPE	5.7	Pag. 1
	A220 300 - ITA	Ed 2 Rev 5/02 nov 23	

5.7 A220 300 - ITA

5.7.1 HOLDS

5.7.1.1 Cargo compartment specifications

CARGO COMPARTMENT SPECIFICATIONS A220 300	
MAX CARGO/BAGS CAPACITY	Kg 5052
MAX CARGO/BAGS VOLUME	m ³ 27,4
FORWARD COMPARTMENTS 1	Kg 2446 - Volume m ³ 12,6 - loose
AFT COMPARTMENTS 4	Kg 2606 - Volume m ³ 14,8 - loose

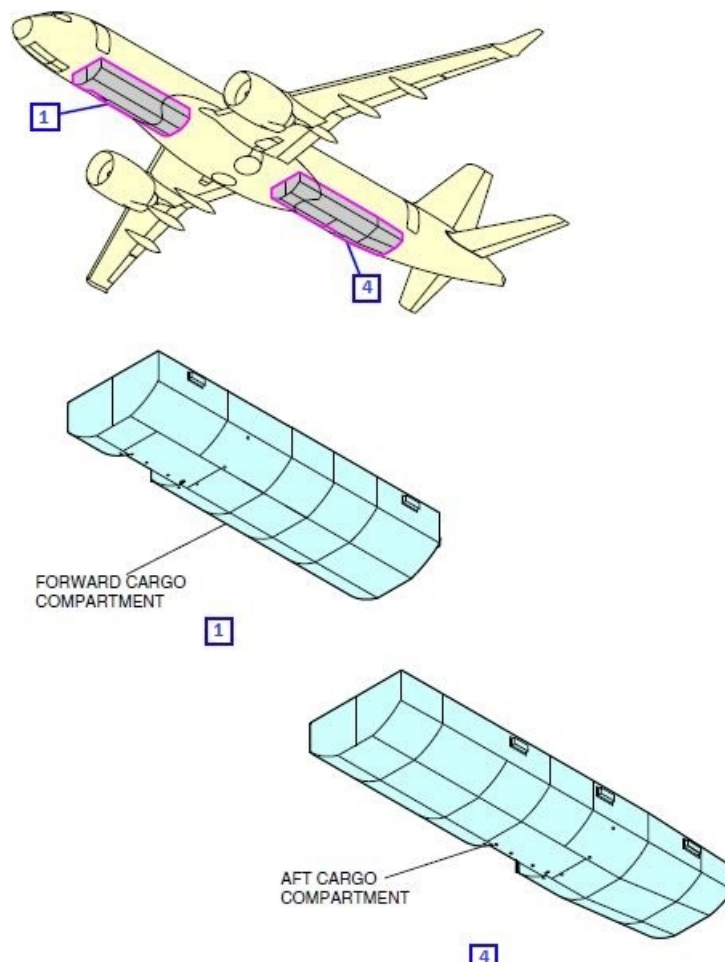

 ITA AIRWAYS Volume II HLM	INFORMATION PER AIRCRAFT TYPE	5.7	Pag. 2
	A220 300 - ITA	Ed 2 Rev 5/02 nov 23	

Aircraft is equipped with forward 1 and aft 4 holds.

In the FORWARD 1 hold there are compartments A and B, separated by a dividing net.

In the AFT hold 4 there are compartments C and F separated by a dividing net.

Each hold is provided with a net opposite to the cargo door.

It is mandatory to fasten all nets (dividing and opposite to cargo door) before flight departure even if holds are empty.

If the divider net is missing or broken, the total maximum load of each compartment shall be respected.

If the door net is missing or broken, fasten the load items individually or consider cargo hold inoperative.



Attention:

In order to avoid damages to internal structure and guarantee the correct functioning of the smoke detection system (which, if necessary, activates fire-fighting system) in holds, it is mandatory to leave always a space of 5cm/2in between load and ceiling. The line marking is defined by a plate installed in front of cargo doors or by a red horizontal strip.

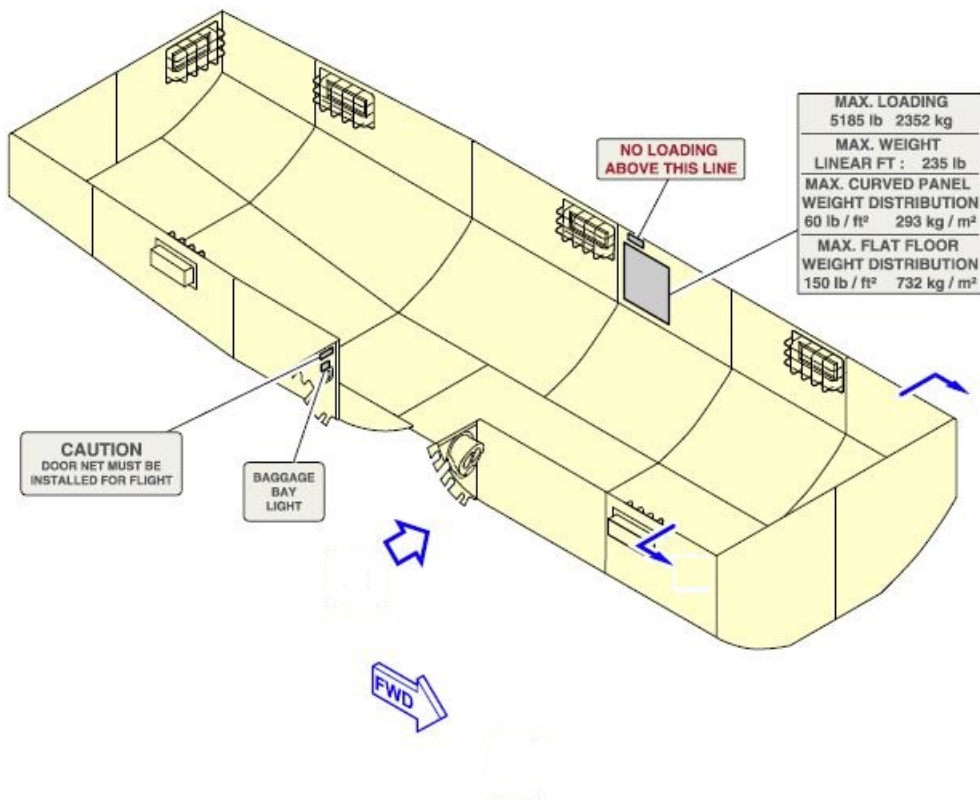

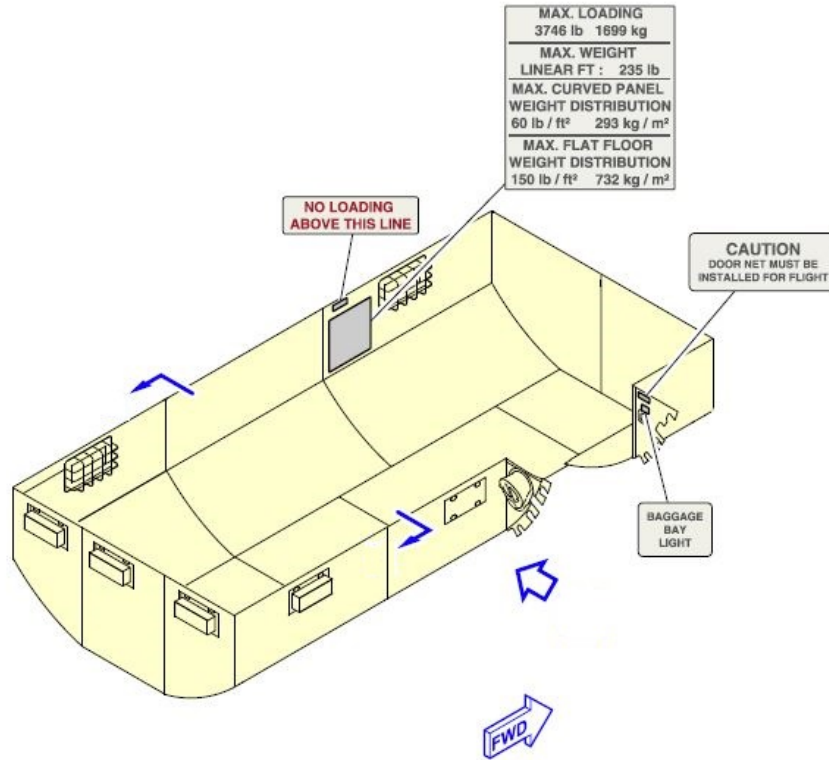

- **FORWARD hold 1**

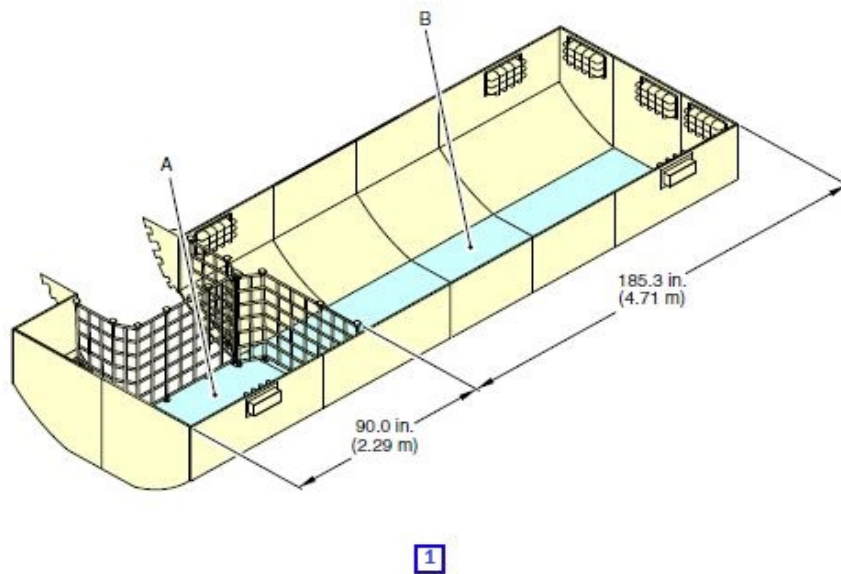
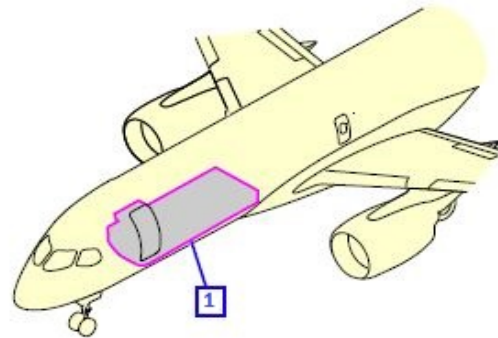

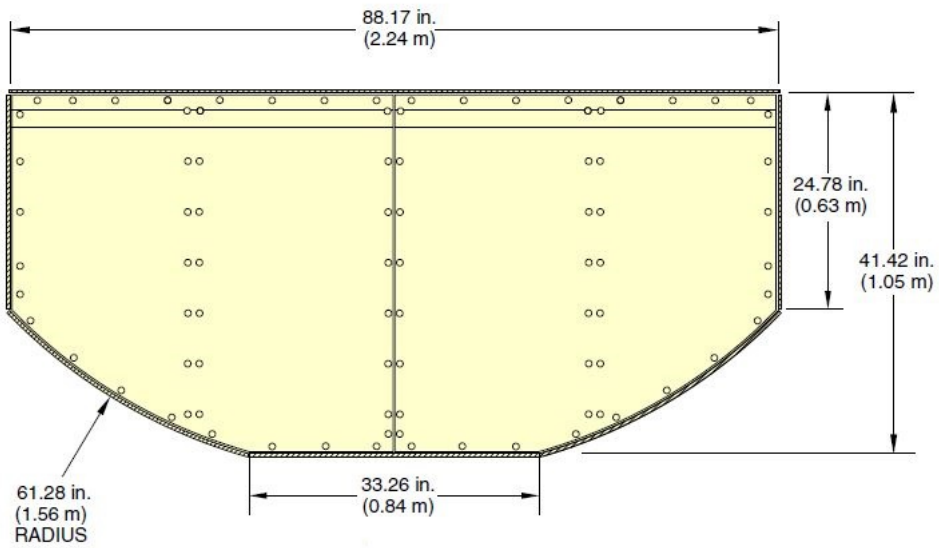
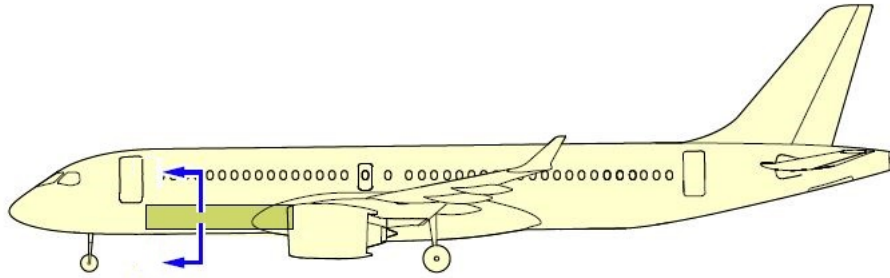

 Volume II HLM	INFORMATION PER AIRCRAFT TYPE	5.7	Pag. 5
	A220 300 - ITA	Ed 2 Rev 1/15 oct 2022	

- cross section

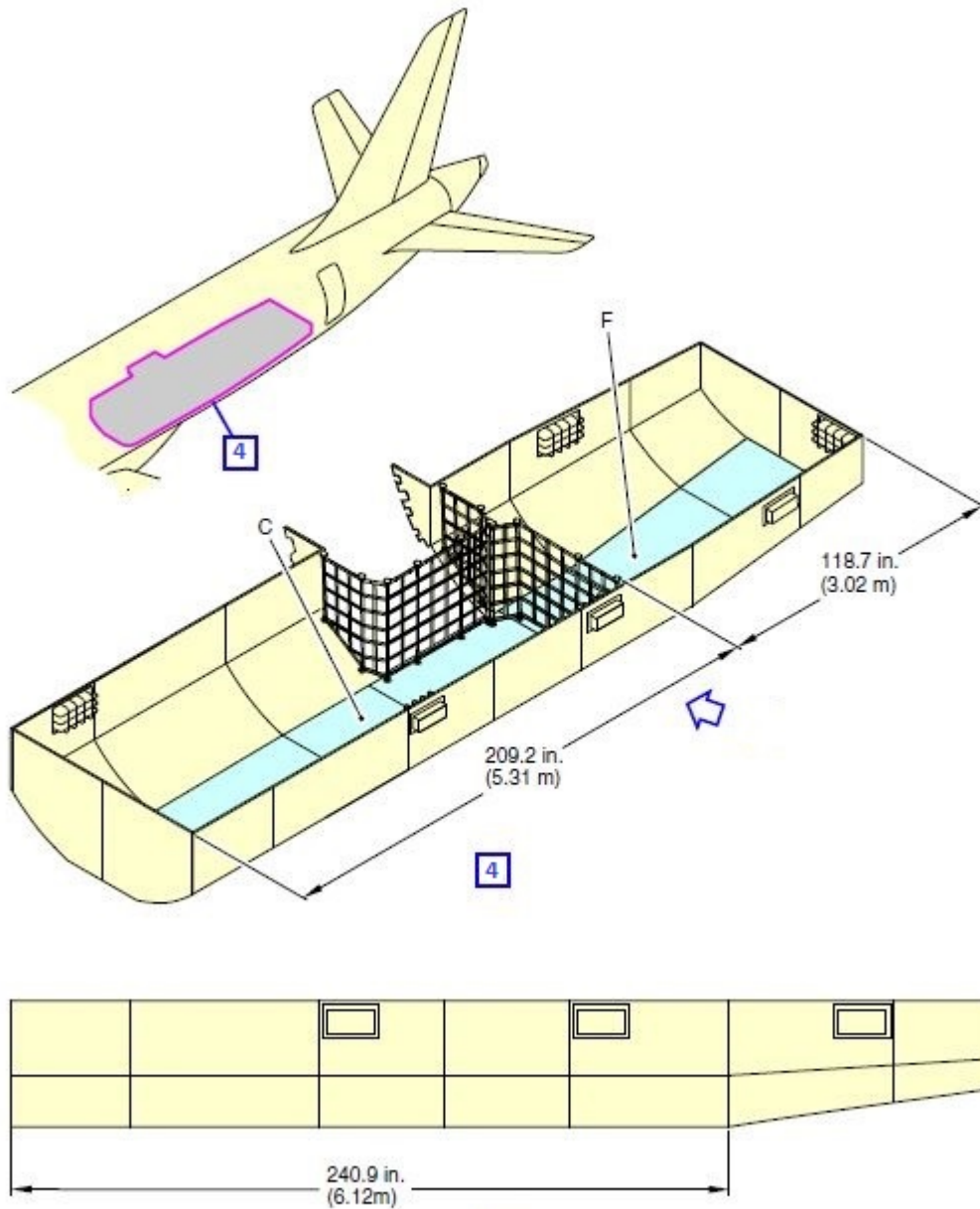

- **AFT hold 4**



 ITA AIRWAYS Volume II HLM	INFORMATION PER AIRCRAFT TYPE	5.7	Pag. 7
	A220 300 - ITA	Ed 2 Rev 1/15 oct 2022	

- cross section

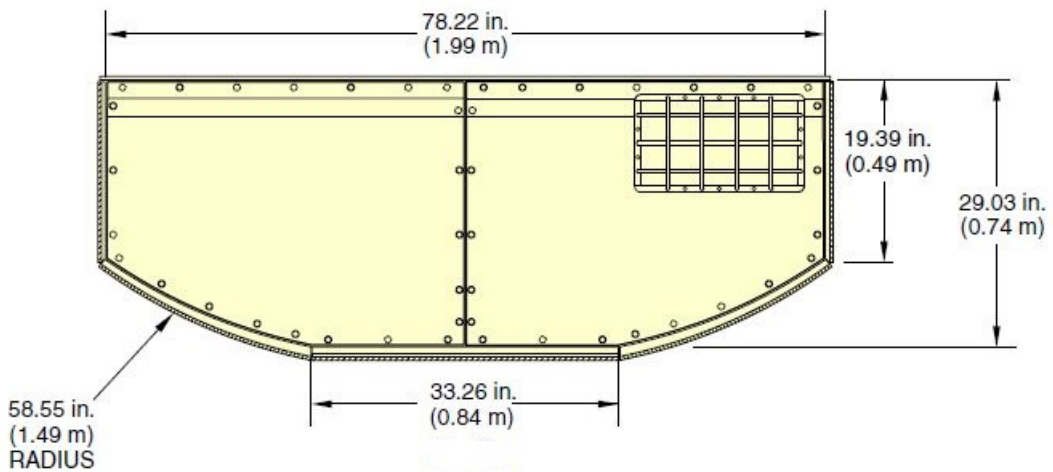
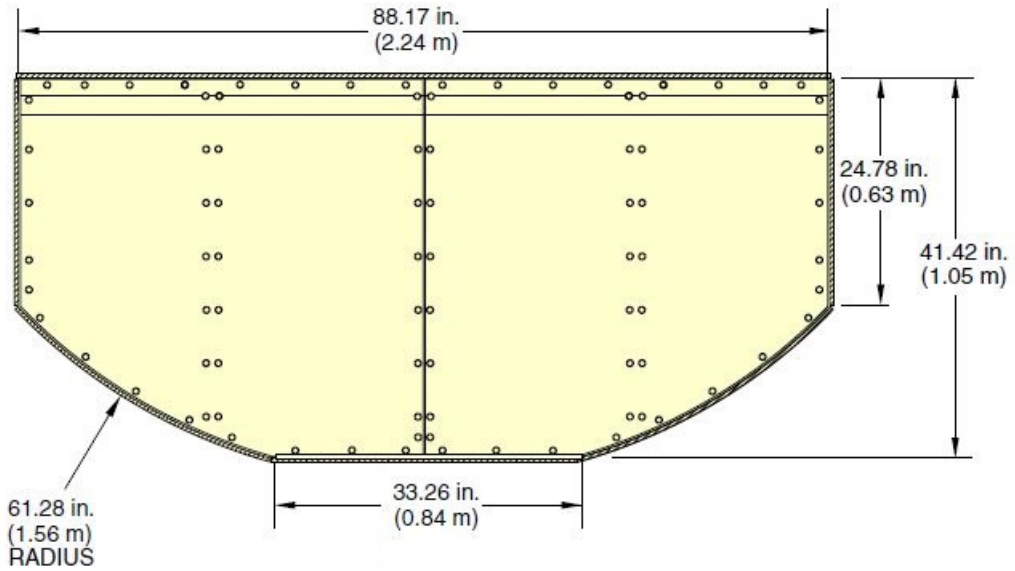
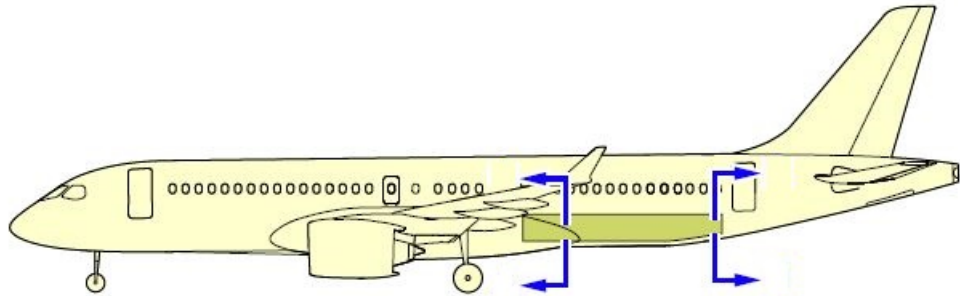

Compartment 4 maximum and minimum height

 Volume II HLM	INFORMATION PER AIRCRAFT TYPE	5.7	Pag. 8
	A220 300 - ITA	Ed 2 Rev 17/27 jan 26	

HOLD	SURFACE RESISTANCE Kg/m ²	USABLE VOLUME m ³	MAXIMUM STRUCTURAL LOAD	
			HOLD Kg	COMPARTMENT Kg
FORWARD	732 on flat floor/ tilted	12,7	2446	A - 800
				B - 1646
AFT	293 on curved floor	14,8	2606	C - 1858
				F - 1055

Holds are pressurized and equipped with the following systems:

- Smoke detection system,
- fire-fighting system,
- Ventilation and heating system (only in forward hold1).



Due to fire extinguishing system feature, shipments containing Dangerous Goods (DG) as flammable and combustibles (class 2.1, 3 and 4) shall be loaded necessarily in the compartment 4. Segregation criteria shall be always respected (i.e. in case of DG class 2.1, 3 and 4, lithium-ion, lithium metal and sodium-ion batteries shall be loaded exclusively in the compartment 1).

5.7.1.2 Holds temperature and ventilation

In order to transport material needing particular temperature and ventilation, following are reported the related aircraft specifications.

HOLD	TEMPERATURE RANGE	VENTILATION	GROUND CONTROL	COCKPIT CONTROL
FORWARD 1	15° - 20° / 20° - 25°	YES	NO	YES
AFT 4		YES	NO	YES

 ITA AIRWAYS Volume II HLM	INFORMATION PER AIRCRAFT TYPE	5.7	Pag. 9
	A220 300 - ITA	Ed 2 Rev 15/07 aug 25	

5.7.1.3 Live Animals (AVI)

AVI can be transported respecting the following loading procedures:

- Maximum cage dimensions 102x84x80 cm,
- Maximum loading weight 325 Kg (animals + cage),
- cage/s shall be positioned in the forward hold 1 (ventilated and heated). Loading of up to 3 cages is allowed. In compartment A, it is possible to load only 1 cage. If positioned in compartment A, the maximum weight of the cage is 68 Kg.
- cage must be tied with one (1) 2000 lb strap ensuring constrain on all directions.

5.7.1.4 Human Remains (HUM)

- Maximum quantity: 2 coffins (one for each hold),
- Maximum dimensions: 205 x 60 x 50 cm (80,7" x 23,6" x 19,6"),
- Maximum weight: 350 Kg,
- Human remain can be loaded in both holds forward and aft, considering weight and balance necessity, and fixed by four (4) 2000lb straps ensuring constrain on all directions.
- When possible, considering weight and balance and space availability, baggage should be loaded in separate compartments.

 ITA AIRWAYS Volume II HLM	INFORMATION PER AIRCRAFT TYPE	5.7	Pag. 10
	A220 300 - ITA	Ed 2 Rev 1/15 oct 2022	

5.7.1.5 Forward cargo door dimensions

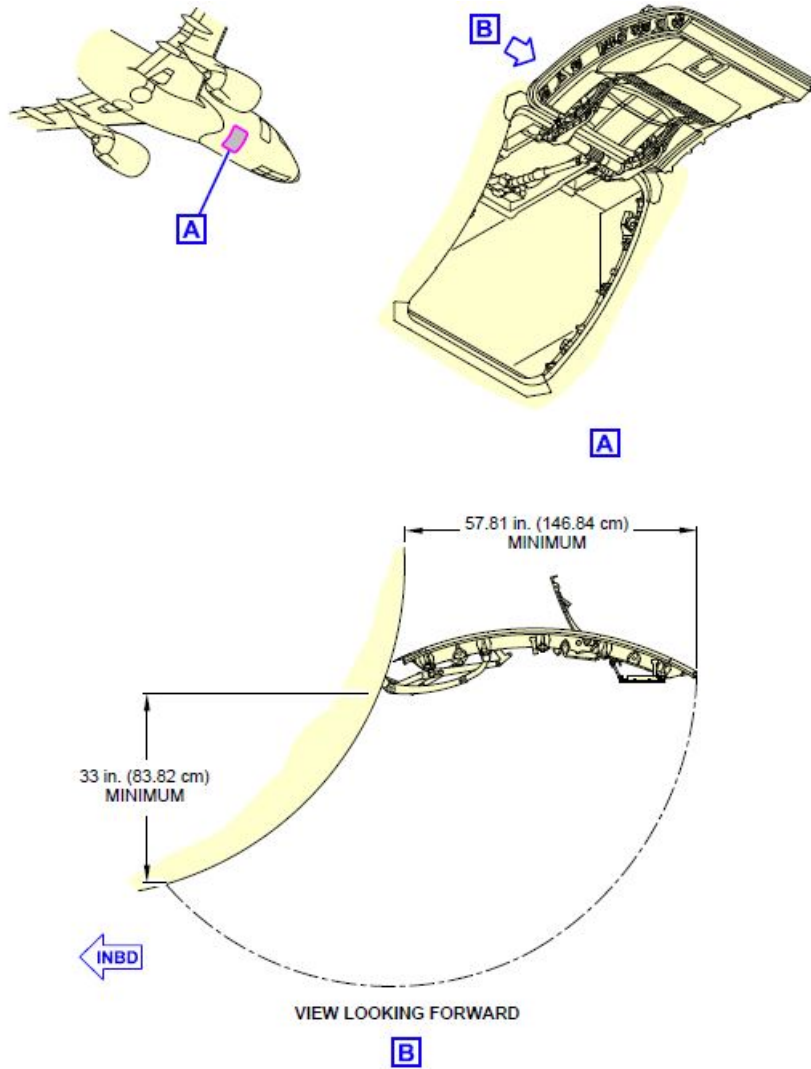

**MAXIMUM DIMENSIONS FOR CONVENTIONAL LOADS
IN FORWARD HOLD 1**

Width (m)	Height (m)									
	0 to 0.304	0.304 to 0.508	0.508 to 0.584	0.584 to 0.635	0.635 to 0.685	0.685 to 0.736	0.736 to 0.762	0.762 to 0.787	0.787 to 0.812	0.812 to 0.838
	Maximum package length (m)									
0 to 0.076	4.826	4.826	4.622	4.114	3.632	3.175	2.946	2.743	2.489	2.209
0.076 to 0.152			4.191	3.784	3.378	2.971	2.768	2.565	2.336	2.108
0.152 to 0.228		4.368	3.860	3.505	3.149	2.794	2.590	2.438	2.235	2.006
0.228 to 0.304	4.572	4.013	3.556	3.251	2.946	2.641	2.463	2.311	2.108	1.905
0.304 to 0.381	4.165	3.708	3.327	3.048	2.768	2.489	2.336	2.209	2.032	1.828
0.381 to 0.457	3.835	3.454	3.124	2.870	2.641	2.362	2.235	2.108	1.930	1.752
0.457 to 0.533	3.556	3.225	2.946	2.717	2.514	2.260	2.133	2.006	1.854	1.676
0.533 to 0.609	3.327	3.022	2.794	2.590	2.387	2.159	2.032	1.930	1.778	1.600
0.609 to 0.685	3.124	2.870	2.641	2.489	2.286	2.082	1.955	1.854	1.727	1.549
0.685 to 0.762	2.971	2.717	2.540	2.362	2.184	2.006	1.879	1.778	1.651	1.498
0.762 to 0.838	2.819	2.616	2.438	2.286	2.108	1.930	1.803	1.727	1.574	1.422
0.838 to 0.914	2.692	2.489	2.336	2.184	2.038	1.854	1.752	1.651	1.524	1.371
0.914 to 0.990	2.565	2.387	2.235	2.108	1.955	1.778	1.676	1.574	1.447	1.295
0.990 to 1.066	2.463	2.286	2.159	2.006	1.854	1.676	1.574	1.473	1.346	1.193
1.066 to 1.168	2.159	1.955	1.803	1.651	1.498	1.320	1.193	1.117	0.965	0.838
NOTE:	Example: The maximum length for a package with a width of 0.760 m and a height of 0.630 m is 2.362 m.									

 Volume II HLM	INFORMATION PER AIRCRAFT TYPE	5.7	Pag. 12
	A220 300 - ITA	Ed 2 Rev 1/15 oct 2022	

5.7.1.6 Aft cargo door dimensions

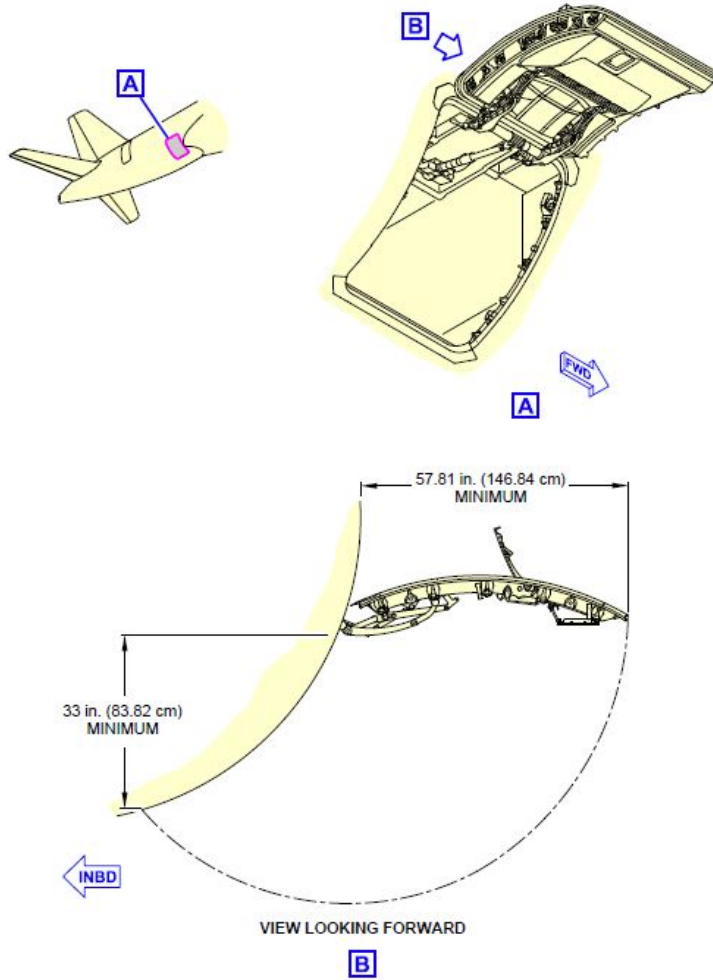

**MAXIMUM DIMENSIONS FOR CONVENTIONAL LOADS
IN AFT HOLD 4**

Width (m)	Height (m)									
	0 to 0.304	0.304 to 0.508	0.508 to 0.584	0.584 to 0.635	0.635 to 0.685	0.685 to 0.736	0.736 to 0.762	0.762 to 0.787	0.787 to 0.812	0.812 to 0.838
Maximum package length (m)										
0 to 0.076	4.826	4.826	4.622	4.114	3.632	3.175	2.946	2.743	2.489	2.209
0.076 to 0.152			4.191	3.784	3.378	2.971	2.768	2.565	2.336	2.108
0.152 to 0.228		4.368	3.860	3.505	3.149	2.794	2.590	2.438	2.235	2.006
0.228 to 0.304	4.572	4.013	3.556	3.251	2.946	2.641	2.463	2.311	2.108	1.905
0.304 to 0.381	4.165	3.708	3.327	3.048	2.768	2.489	2.336	2.209	2.032	1.828
0.381 to 0.457	3.835	3.454	3.124	2.870	2.641	2.362	2.235	2.108	1.930	1.752
0.457 to 0.533	3.556	3.225	2.946	2.717	2.514	2.260	2.133	2.006	1.854	1.676
0.533 to 0.609	3.327	3.022	2.794	2.590	2.387	2.159	2.032	1.930	1.778	1.600
0.609 to 0.685	3.124	2.870	2.641	2.489	2.286	2.082	1.955	1.854	1.727	1.549
0.685 to 0.762	2.971	2.717	2.540	2.362	2.184	2.006	1.879	1.778	1.651	1.498
0.762 to 0.838	2.819	2.616	2.438	2.286	2.108	1.930	1.803	1.727	1.574	1.422
0.838 to 0.914	2.692	2.489	2.336	2.184	2.038	1.854	1.752	1.651	1.524	1.371
0.914 to 0.990	2.565	2.387	2.235	2.108	1.955	1.778	1.676	1.574	1.447	1.295
0.990 to 1.066	2.463	2.286	2.159	2.006	1.854	1.676	1.574	1.473	1.346	1.193
1.066 to 1.168	2.159	1.955	1.803	1.651	1.498	1.320	1.193	1.117	0.965	0.838
NOTE:	Example: The maximum length for a package with a width of 0.760 m and a height of 0.630 m is 2.362 m.									

Width (m)	Height (m)									
	0 to 0.304	0.304 to 0.508	0.508 to 0.584	0.584 to 0.635	0.635 to 0.685	0.685 to 0.736	0.736 to 0.762	0.762 to 0.787	0.787 to 0.812	0.812 to 0.838
	Maximum package length (m)									
0 to 0.076	4.064	4.064	4.064	3.886	3.454	3.048	2.819	2.667	2.413	2.184
0.076 to 0.152			3.962	3.556	3.200	2.844	2.692	2.514	2.311	2.057
0.152 to 0.228			3.632	3.327	3.022	2.717	2.540	2.413	2.184	2.006
0.228 to 0.304			3.810	3.403	3.149	2.844	2.565	2.438	2.286	2.082
0.304 to 0.381	3.962	3.556	3.225	2.946	2.717	2.438	2.311	2.159	1.981	1.828
0.381 to 0.457	3.657	3.302	3.022	2.819	2.565	2.336	2.209	2.082	1.930	1.752
0.457 to 0.533	3.429	3.124	2.844	2.667	2.438	2.235	2.108	2.006	1.854	1.676
0.533 to 0.609	3.225	2.946	2.717	2.540	2.362	2.133	2.006	1.930	1.778	1.600
0.609 to 0.685	3.048	2.819	2.590	2.413	2.260	2.057	1.955	1.854	1.727	1.549
0.685 to 0.762	2.870	2.667	2.463	2.336	2.159	2.006	1.879	1.778	1.651	1.498
0.762 to 0.838	2.768	2.540	2.387	2.260	2.082	1.930	1.803	1.727	1.574	1.422
0.838 to 0.914	2.616	2.438	2.311	2.159	2.006	1.854	1.752	1.651	1.524	1.371
0.914 to 0.990	2.514	2.362	2.209	2.082	1.955	1.778	1.676	1.574	1.447	1.295
0.990 to 1.066	2.438	2.260	2.108	2.006	1.854	1.676	1.574	1.473	1.346	1.193
1.066 to 1.168	2.133	1.955	1.803	1.651	1.498	1.320	1.193	1.117	0.965	0.838
<p>CAUTION: If the package sits on the canted floor, validate that the load distribution do not exceed the floor capacity.</p> <p>NOTE: Example: The maximum length for a package with a width of 0.760 m and a height of 0.630 m is 2.336 m.</p>										

 ITA AIRWAYS Volume II HLM	INFORMATION PER AIRCRAFT TYPE	5.7	Pag. 15
	A220 300 - ITA	Ed 2 Rev 1/15 oct 2022	

5.7.2 Cargo doors opening

The control panel for the cargo door (fwd and aft) functioning is used to activate the actuators for the opening and closing of fwd and aft cargo compartments doors. The panel consists of three buttons. Two are needed to lift and lower the door, the third to switch on the loading area lights (LAL). Includes the following switches:

OPEN switch

a green button, marked with an arrow pointed upwards, allows the ground personnel to open the cargo compartment door.

CLOSE switch

a red button, marked with an arrow pointed downward allows the ground personnel to close the cargo compartment door.

LIGHT switch

a yellow button, used to turn on the LAL of the respective cargo compartment door.

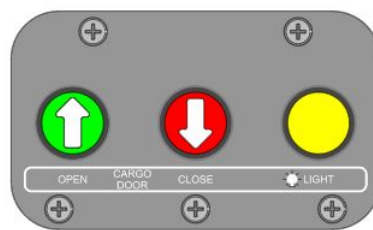
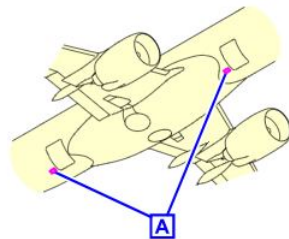

CARGO COMPARTMENT DOOR
ACTUATOR CONTROL PANEL

A

It is forbidden to activate or leave the doors opened when wind is more than 40 knots.

 Volume II HLM	INFORMATION PER AIRCRAFT TYPE	5.7	Pag. 16
	A220 300 - ITA	Ed 2 Rev 1/15 oct 2022	

5.7.3 FUEL

The aircraft has three tanks. Below is a table of capacity (average reference density of 0.809 kg/lit).

	WEIGHT Kg	VOLUME Lt
LEFT WING TANK	3050	3770
RIGHT WING TANK	3050	3770
CENTER TANK	11300	13968
TOTAL	17400	21508

 ITA AIRWAYS Volume II HLM	INFORMATION PER AIRCRAFT TYPE	5.7	Pag. 17
	A220 300 - ITA	Ed 2 Rev 1/15 oct 2022	

5.7.4 USE OF MARKER CONES

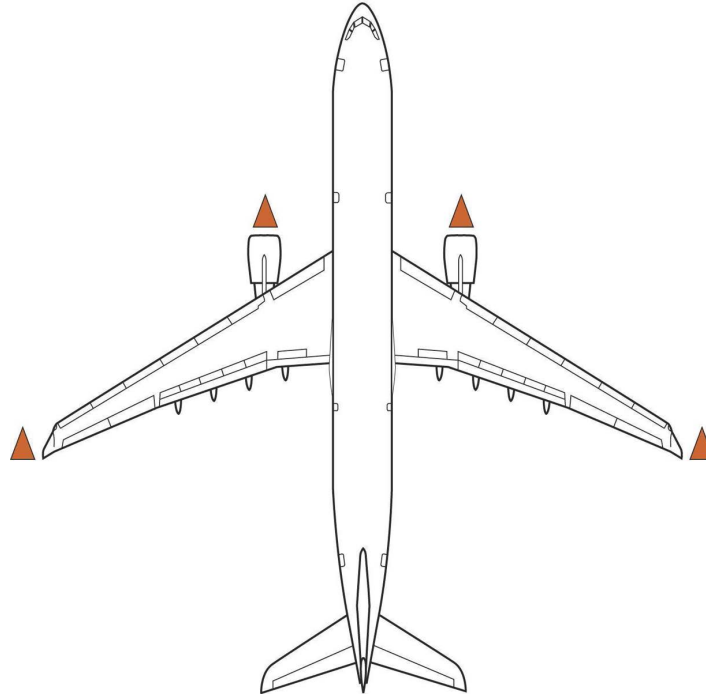

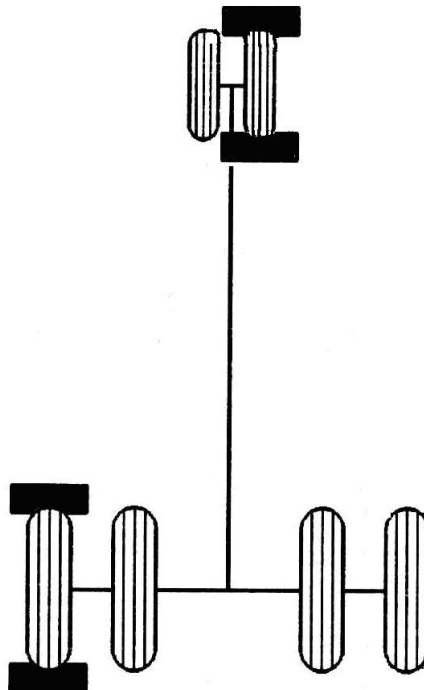

5.7.5 CHOCKING OF AIRCRAFT

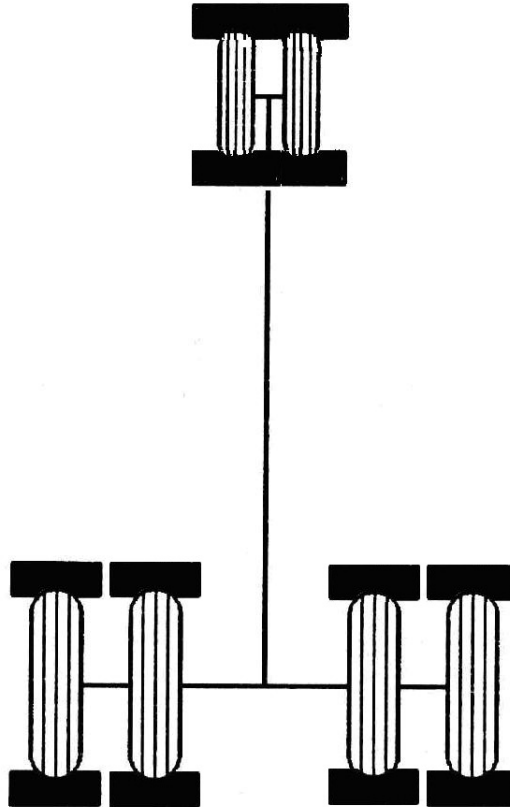

 Volume II HLM	INFORMATION PER AIRCRAFT TYPE	5.7	Pag. 18
	A220 300 - ITA	Ed 2 Rev 1/15 oct 2022	

5.7.6 Chocking of aircraft with wind over 25kt (46.3 km/h)



 ITA AIRWAYS Volume II HLM	INFORMATION PER AIRCRAFT TYPE	5.7	Pag. 19
	A220 300 - ITA	Ed 2 Rev 1/15 oct 2022	

5.7.7 TOILETTE DRAIN

Below is the procedure for draining, rinsing and refilling disinfected water:

1. Open the service panel.
2. Open the drain valve cover.
3. Connect the drainage pipe and ensure it is well connected. Lower the reed valve actuator 90 degrees to allow the drain valve to open.
4. Proceed with drainage according to the type of GSE used.
5. When draining, ensure that the liquid drains from the pipe

Note: If the drainage does not drain properly, inform a company representative.

6. Connect the rinse hose to the service panel rinse fit.
7. Rinse the waste tank with 75 liters (no less than 50 liters) of disinfected fluid for 2,5 minutes (no less than 2), pressure shall be between 25 and 60 PSI.
8. Make sure that there is no fluid flow in the drain hose.
9. Move the actuation lever to 90 degrees up to close the drain valve.
10. Disconnect the drain hose from the drain valve.
11. Add 7,5 liters of precharge fluid.

Note: In case of leakage from the drain valve inform immediately a Company representative.

11. Disconnect the rinse hose from the rinse fittings.
12. Close the rinse fitting cap.
13. Clean the inner and external surfaces of the waste servicing area with a dry cloth.

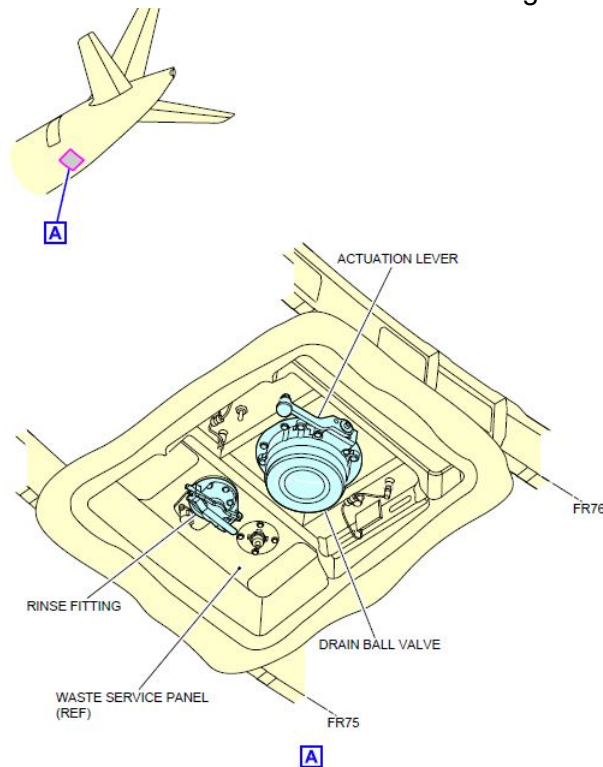

 Volume II HLM	INFORMATION PER AIRCRAFT TYPE	5.7	Pag. 20
	A220 300 - ITA	Ed 2 Rev 1/15 oct 2022	

5.7.8 FILLING POTABLE WATER

Following, procedure for potable water supply operation:

1. If refuelling is carried out without the aid of the CMS (Cabin management System), proceed from point 4
2. Access the CMS screen in the cabin and select LAVATORY
3. Pre-select the amount of water to be supplied (10% increments can be entered)
4. Open the service panel door.
5. Connect the fill hose to the filling valve.
6. Set the FILL/DRAIN switch to the FILL position.
7. On the potable water cart open the water supply valve and make sure that the fill pressure is at 25 to 60 psi.
7. When the water fill process is completed, make sure that the FULL light comes on the water level indicator.
8. Make sure that the CMS shows the correct water level value which is set.
9. Close the water supply valve.
10. Disconnect the fill hose from the fill nipple and completely let the water purge from the fill nipple for approximately 3 minutes.
11. Close the fill nipple valve and set the FILL/DRAIN switch to FLIGHT

Note: In case of leakage from the drain valve inform immediately a Company representative..

Note: With temperatures close to or below 0 °C, make sure that the residual water is completely drained before replacing the cap.

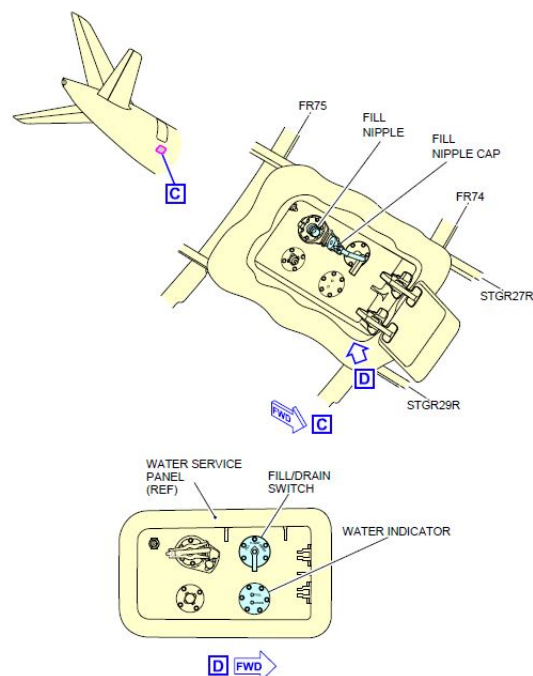

Nota: The standard quantity of water to be supplied is 60%.

 Volume II HLM	INFORMATION PER AIRCRAFT TYPE	5.7	Pag. 21
	A220 300 - ITA	Ed 2 Rev 1/15 oct 2022	

5.7.9 BULK HOLDS LOADING/UNLOADING ASSISTANCE

Only belt loaders are allowed for loading/unloading.

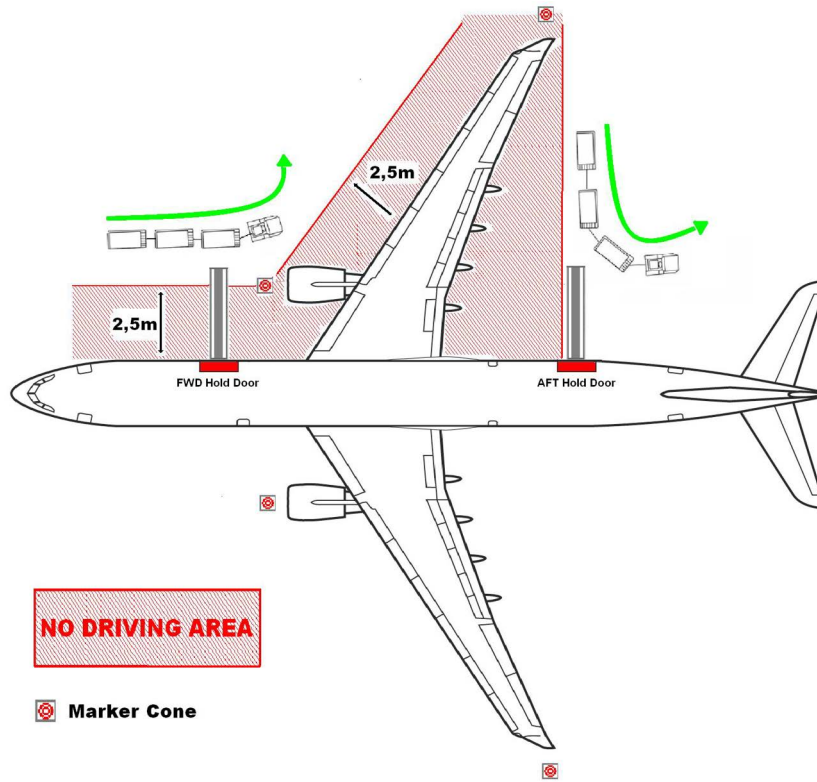

5.7.10 PRE DEPARTURE SERVICING CHECK LIST

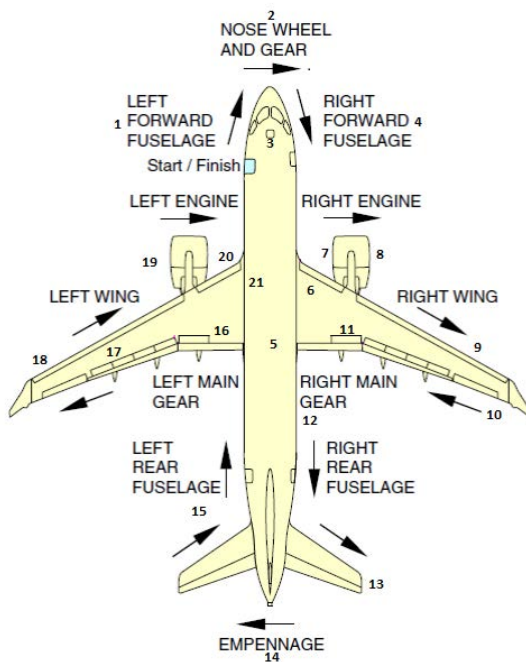

Predeparture Servicing Check List A220		
N°	Aircraft section	Action (*)
1	left fwd fuselage	condition
	left fwd passengers door	closed
2	pitot-static tubes	condition
	static port	clear
	ground power access door panel	closed
3	nose gear chocks (**) or	positioned
	push back track wheels and tires	connected condition
	Hydraulic Safety Pin	connected (push back) or removed (power out)
4	right fwd fuselage	condition
	right fwd passenger door	closed and checked
	right fwd cargo door	closed and checked
5	central fuselage	condition
	potable water access panel	closed
	LP e HP connection access	closed
	anticollision light (beacon)	on
6/9/10	right wing	condition
	fuel panel	closed
7/8	right wing	condition
11	landing gear chocks (**) wheels and tires	removed condition
12	right rear fuselage	condition
	right rear cargo door	closed and checked
	right rear passenger door	closed and checked
	bulk door	closed and checked
	waste service panel	closed
13	empennage	condition
14	exhaust	clear
15	left rear fuselage	condition
	left rear passengers dor	closed and checked
	potable water panel	closed
16	left landing gear chocks (**) wheels and tires	removed condition
17/18/21	left wing	condition
19/20	left engine	condition
(*)The term <i>condition</i> means that the following items have been verified: obvious damage, obvious liquid leakage and handles flush with the fuselage.		
(**) the ground personnel must ensure that parking brakes have been set prior to removal		

 ITA AIRWAYS Volume II HLM	INFORMATION PER AIRCRAFT TYPE	5.7	Pag. 23
	A220 300 - ITA	Ed 2 Rev 1/15 oct 2022	

5.7.11 SAFETY AREAS

5.7.11.1 Idle thrust - Intake and Blast Areas

Intake and Blast areas when aircraft on idle thrust shall be observed and neither personnel or equipment shall be positioned inside such areas when engines are running.

Blast areas are referred to the back of the aircraft, starting from the back edge of the running engine. Safety distance shown in the following table shall be observed.

IDLE THRUST (Danger areas length)		
- A - INTAKE AREA	- B -	- C - BLAST AREA
idle 2.74 m take-off power 6.1 m	corridor	idle 61 m take-off power 145 m

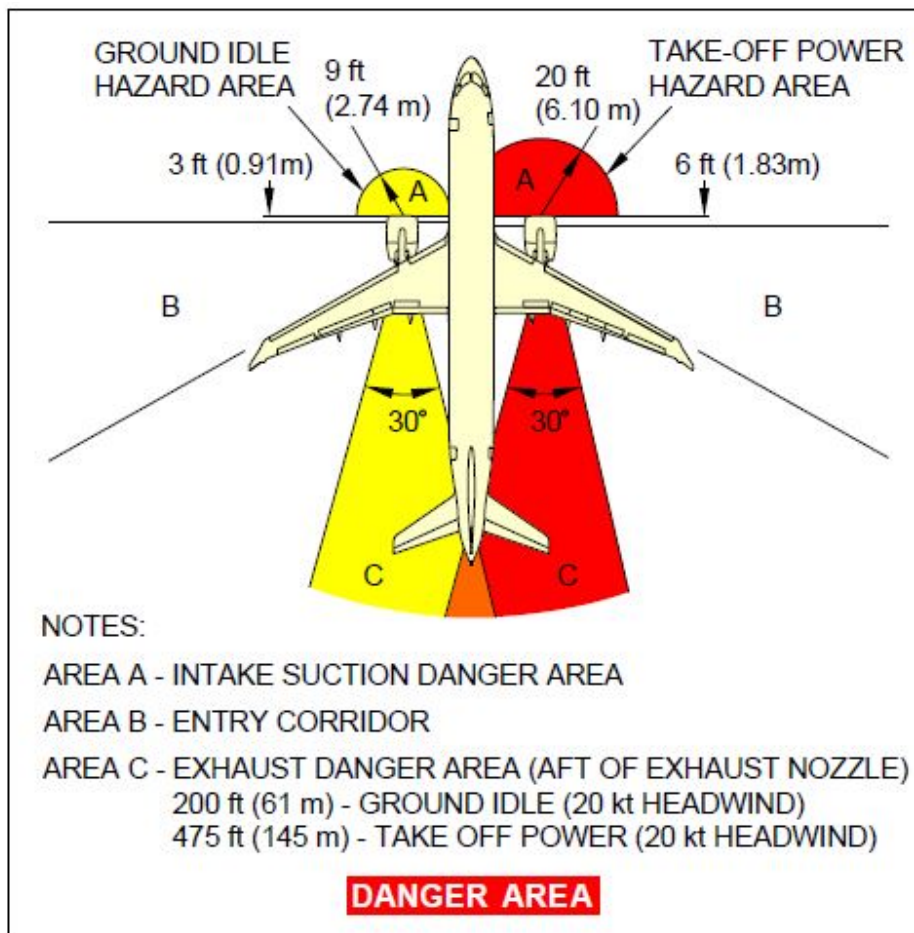

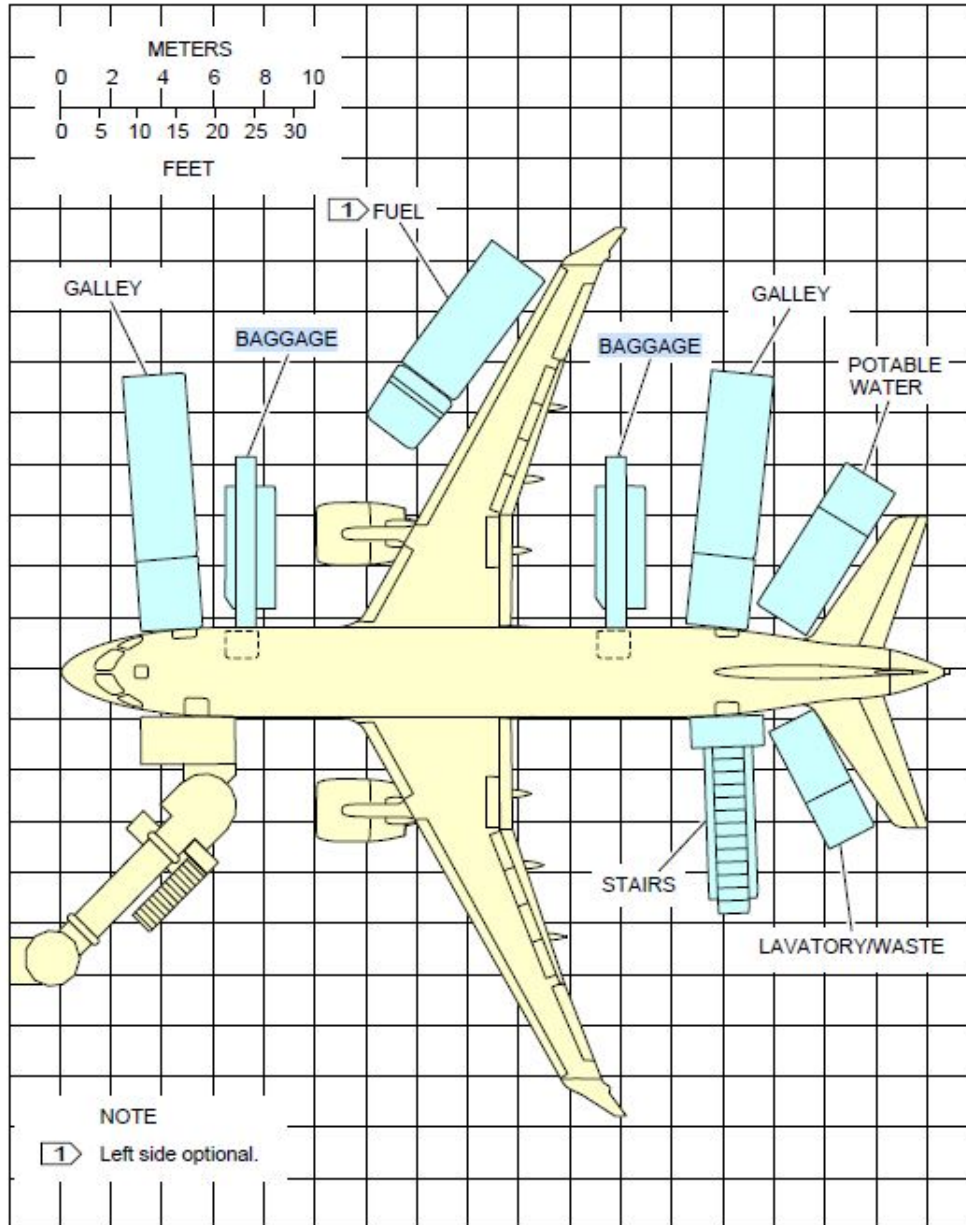

5.7.12 SERVICING ARRANGEMENTS

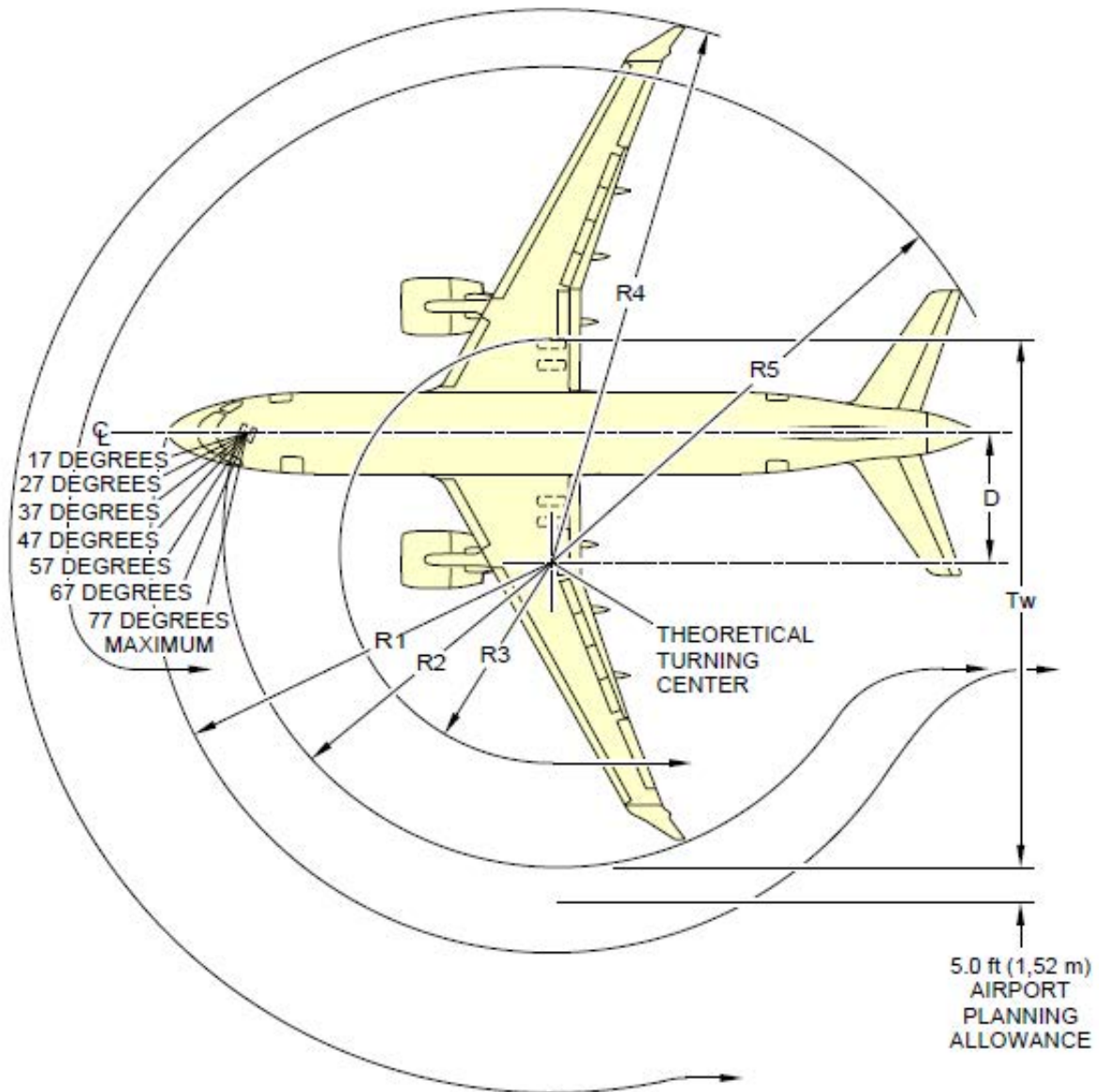

5.7.13 Steering limits

turning angle in degree	turning center to center line	R1 nose tip	R2 nose gear	R3 main gear	R4 wing tip	R5 empennage tip	Minimum theoretical pavement width for 180 degrees turn
17	49822 mm	53193 mm	52415 mm	53858 mm	67539 mm	58600 mm	105359 mm
27	29896 mm	35227 mm	33868 mm	33929 mm	47716 mm	40041 mm	67798 mm
37	20213 mm	27493 mm	25626 mm	24249 mm	38123 mm	31628 mm	49875 mm
47	14204 mm	23431 mm	21143 mm	18240 mm	32194 mm	26843 mm	39383 mm
57	9891 mm	21097 mm	18478 mm	13927 mm	27963 mm	23752 mm	32405 mm
67	6467 mm	19723 mm	16863 mm	10500 mm	24623 mm	21598 mm	27366 mm
77	3518 mm	18964 mm	15949 mm	7551 mm	21756 mm	20028 mm	23505 mm



 ITA AIRWAYS Volume II HLM	INFORMATION PER AIRCRAFT TYPE	5.8	Pag. 1
	A220 100 - ITA	Ed 2 Rev 5/02 nov 23	

5.8 A220 100 - ITA

5.8.1 HOLDS

5.8.1.1 Cargo compartment specifications

CARGO COMPARTMENT SPECIFICATIONS A220 300	
MAX CARGO/BAGS CAPACITY	Kg 3760
MAX CARGO/BAGS VOLUME	m ³ 20,75
FORWARD COMPARTMENTS 1	Kg 1697 - Volume m ³ 8,8 - loose
AFT COMPARTMENTS 4	Kg 2063 - Volume m ³ 11,95 - loose

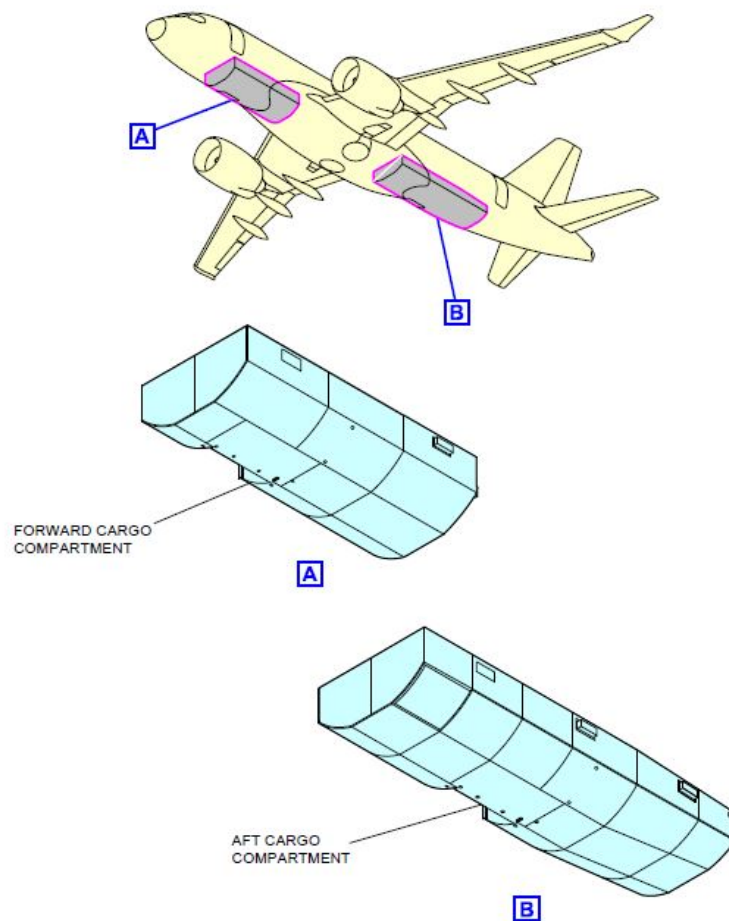

 ITA AIRWAYS Volume II HLM	INFORMATION PER AIRCRAFT TYPE	5.8	Pag. 2
	A220 100 - ITA	Ed 2 Rev 5/02 nov 23	

Aircraft is equipped with forward 1 and aft 4 holds.

In the FORWARD 1 hold there are compartments A and B, separated by a dividing net.

In the AFT hold 4 there are compartments C and F separated by a dividing net.

Each hold is provided with a net opposite to the cargo door.

It is mandatory to fasten all nets (dividing and opposite to cargo door) before flight departure even if holds are empty.

If the divider net is missing or broken, the total maximum load of each compartment shall be respected.

If the door net is missing or broken, fasten the load items individually or consider cargo hold inoperative.



Attention:

In order to avoid damages to internal structure and guarantee the correct functioning of the smoke detection system (which, if necessary, activates fire-fighting system) in holds, it is mandatory to leave always a space of 5cm/2in between load and ceiling. The line marking is defined by a plate installed in front of cargo doors or by a red horizontal strip.

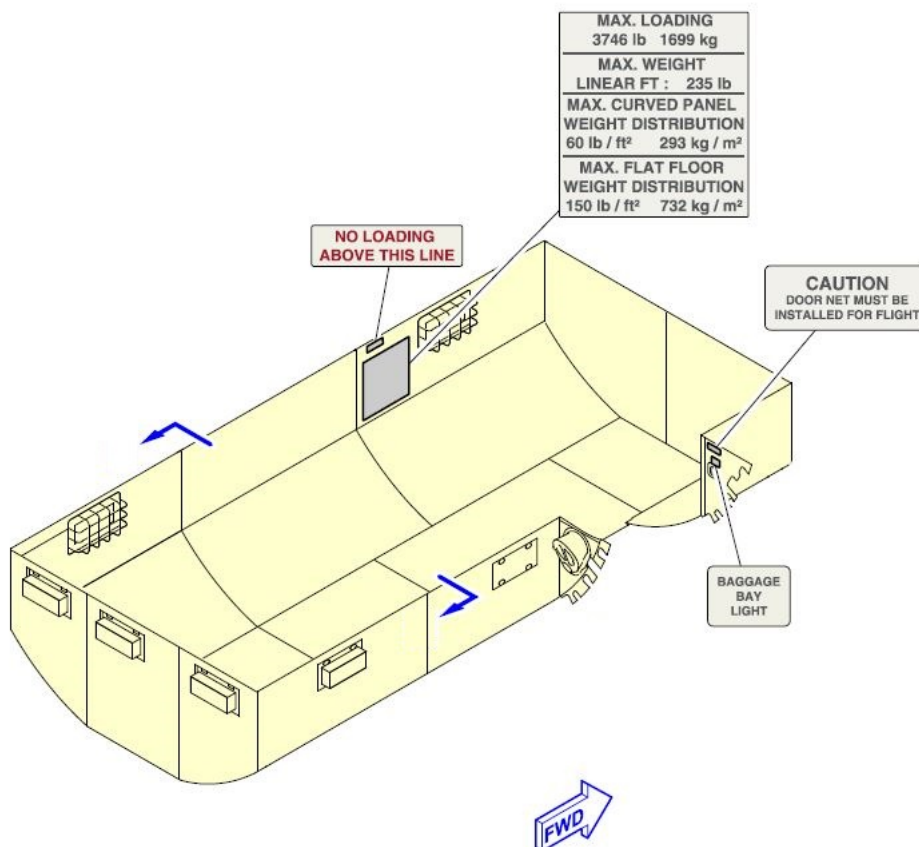

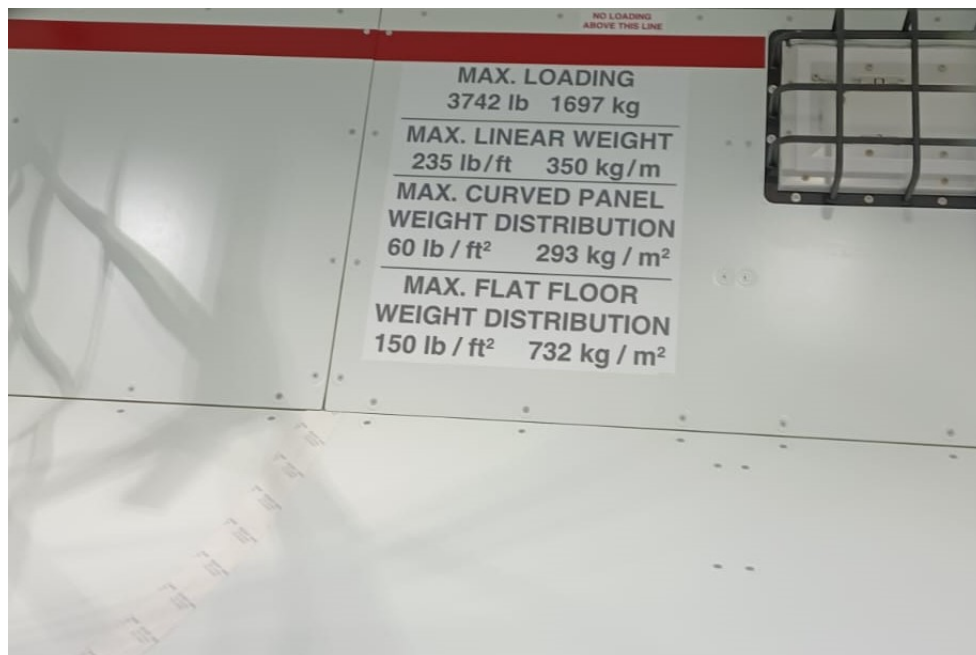
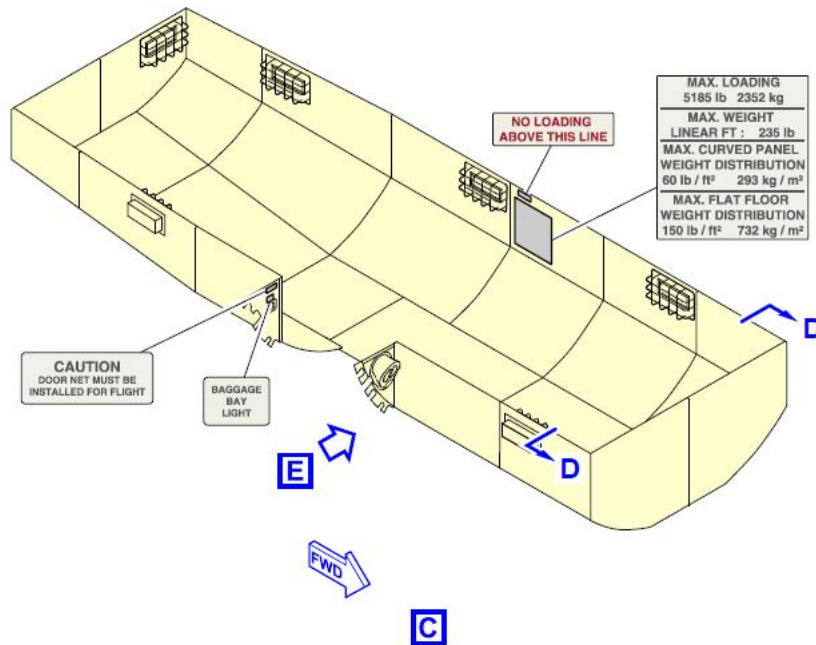

 ITA AIRWAYS Volume II HLM	INFORMATION PER AIRCRAFT TYPE	5.8	Pag. 4
	A220 100 - ITA	Ed 2 Rev 5/02 nov 23	

- Forward hold 1

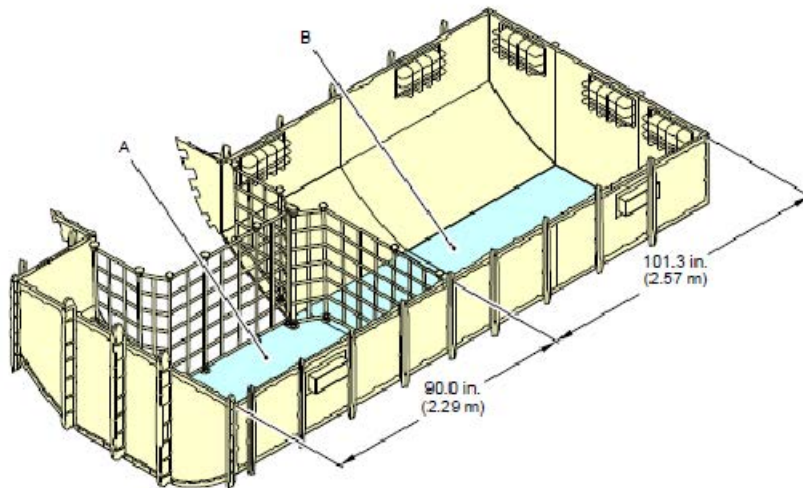
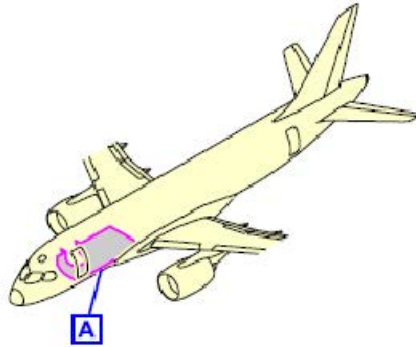

A

 Volume II HLM	INFORMATION PER AIRCRAFT TYPE	5.8	Pag. 5
	A220 100 - ITA	Ed 2 Rev 5/02 nov 23	

- cross section

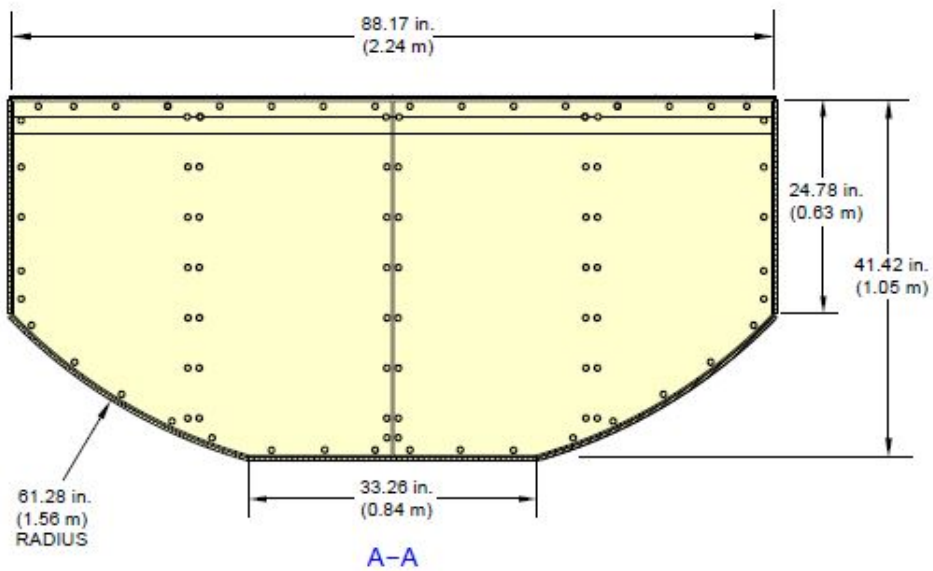
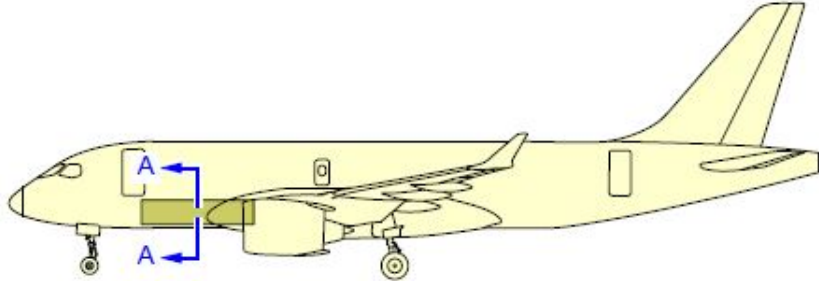

 ITA AIRWAYS Volume II HLM	INFORMATION PER AIRCRAFT TYPE	5.8	Pag. 6
	A220 100 - ITA	Ed 2 Rev 5/02 nov 23	

- Aft hold 4

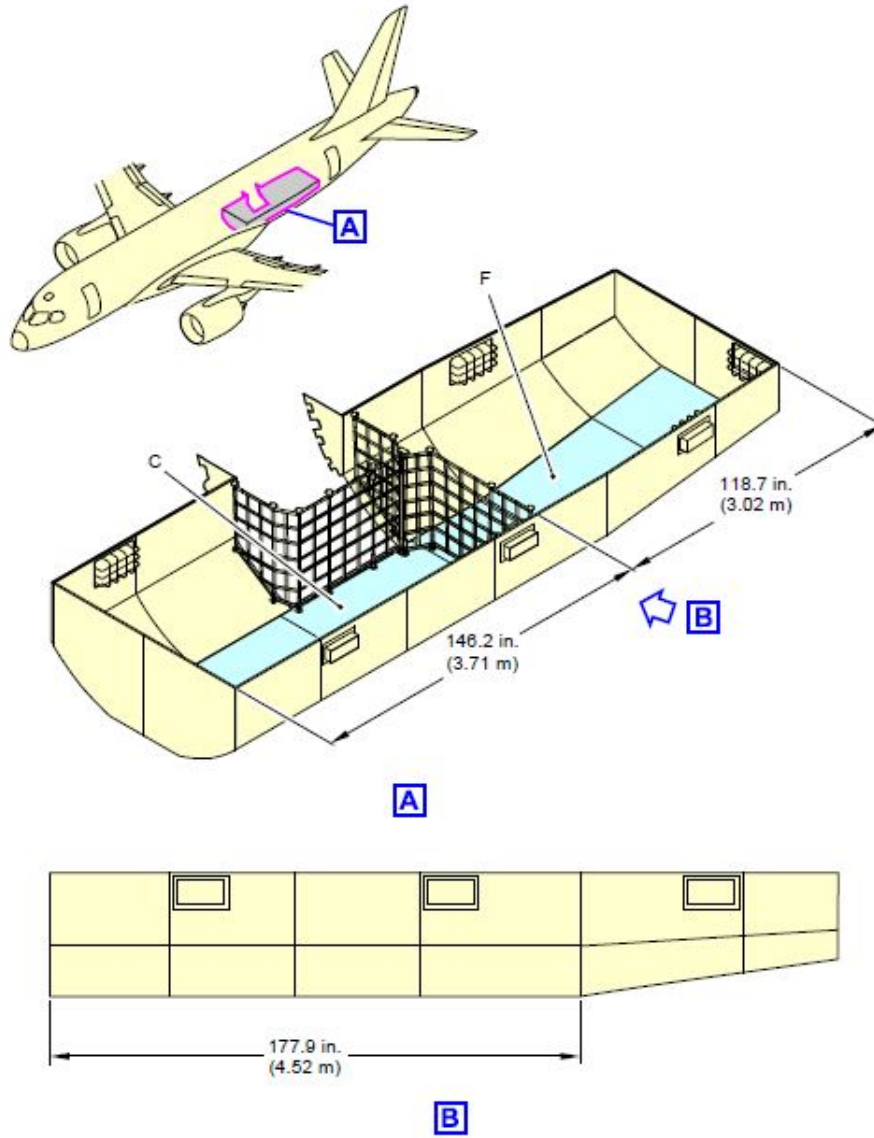

 ITA AIRWAYS Volume II HLM	INFORMATION PER AIRCRAFT TYPE	5.8	Pag. 7
	A220 100 - ITA	Ed 2 Rev 5/02 nov 23	

- cross section

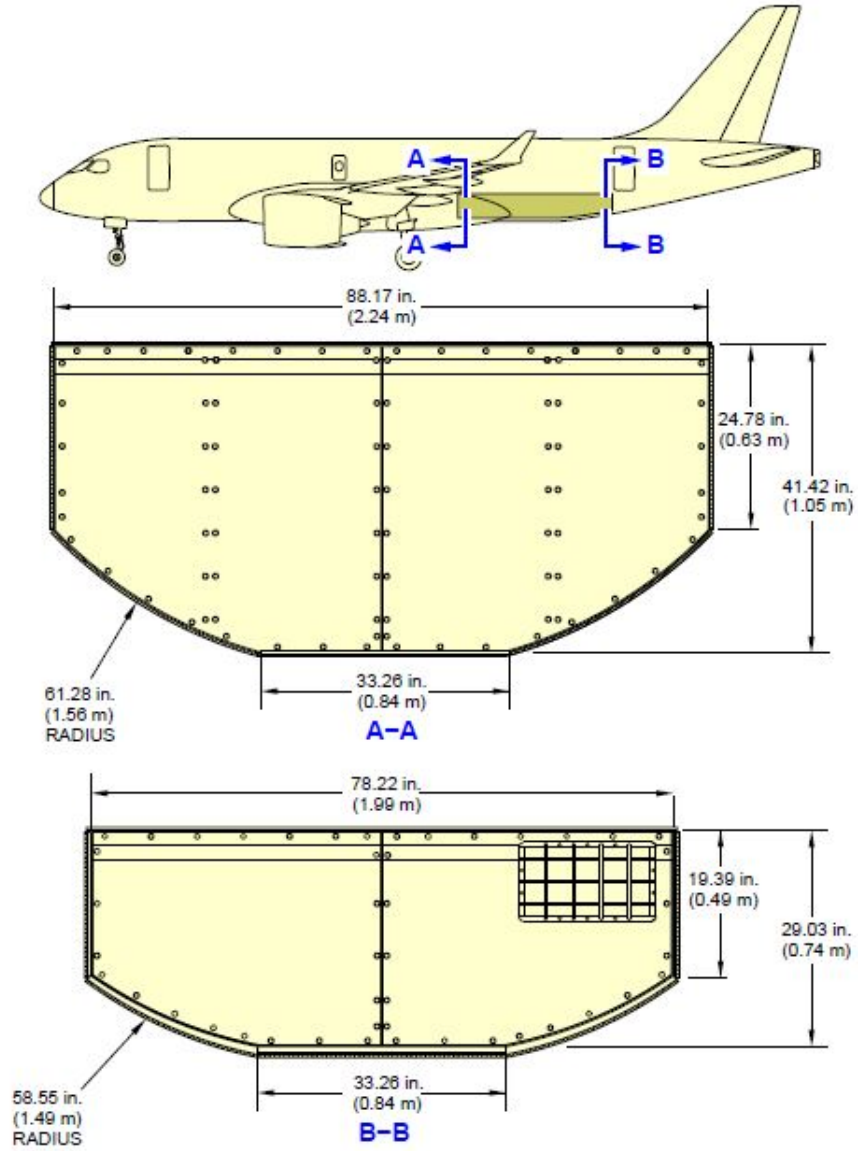

 Volume II HLM	INFORMATION PER AIRCRAFT TYPE	5.8	Pag. 8
	A220 100 - ITA	Ed 2 Rev 17/27 jan 26	

HOLD	SURFACE RESISTANCE Kg/m ²	USABLE VOLUME m ³	MAXIMUM STRUCTURAL LOAD	
			HOLD Kg	COMPARTMENT Kg
FORWARD	732 on flat floor/ tilted	8,8	1697	A - 800
				B - 900
AFT	293 on curved floor	11,95	2063	C - 1298
				F - 1055

Holds are pressurized and equipped with the following systems:

- Smoke detection system,
- fire-fighting system,
- Ventilation and heating system (only in forward hold1).



Due to fire extinguishing system feature, shipments containing Dangerous Goods (DG) as flammable and combustibles (class 2.1, 3 and 4) shall be loaded necessarily in the compartment 4. Segregation criteria shall be always respected (i.e. in case of DG class 2.1, 3 and 4, lithium-ion, lithium metal and sodium-ion batteries shall be loaded exclusively in the compartment 1).

5.8.1.2 Holds temperature and ventilation

In order to transport material needing particular temperature and ventilation, following are reported the related aircraft specifications.

HOLD	TEMPERATURE RANGE	VENTILATION	GROUND CONTROL	COCKPIT CONTROL
FORWARD 1	15° - 20° / 20° - 25°	YES	NO	YES
AFT 4		YES	NO	YES

 Volume II HLM	INFORMATION PER AIRCRAFT TYPE	5.8	Pag. 9
	A220 100 - ITA	Ed 2 Rev 15/07 aug 25	

5.8.1.3 Live Animals (AVI)

AVI can be transported respecting the following loading procedures:

- Maximum cage dimensions 102x84x80 cm,
- Maximum loading weight 72 Kg (animals + cage),
- cage shall be positioned in the forward hold 1 (ventilated and heated). Loading of up to 1 cage is allowed. If positioned in compartment A, the maximum weight of the cage is 68 Kg.
- cage must be tied with one (1) 2000 lb strap ensuring constrain on all directions.

5.8.1.4 Human Remains (HUM)

- Maximum quantity: 1 coffin
- Maximum dimensions: 205 x 60 x 50 cm (80,7" x 23,6" x 19,6"),
- Maximum weight: 350 Kg,
- Human remain can be loaded in both holds forward (pos B) and aft, considering weight and balance necessity, and fixed by four (4) 2000lb straps ensuring constrain on all directions.

When possible, considering weight and balance and space availability, baggage should be loaded in separate compartments.

 ITA AIRWAYS Volume II HLM	INFORMATION PER AIRCRAFT TYPE	5.8	Pag. 10
	A220 100 - ITA	Ed 2 Rev 5/02 nov 23	

5.8.1.5 Cargo doors dimensions

Dimensions of both fwd and aft cargo doors are the same

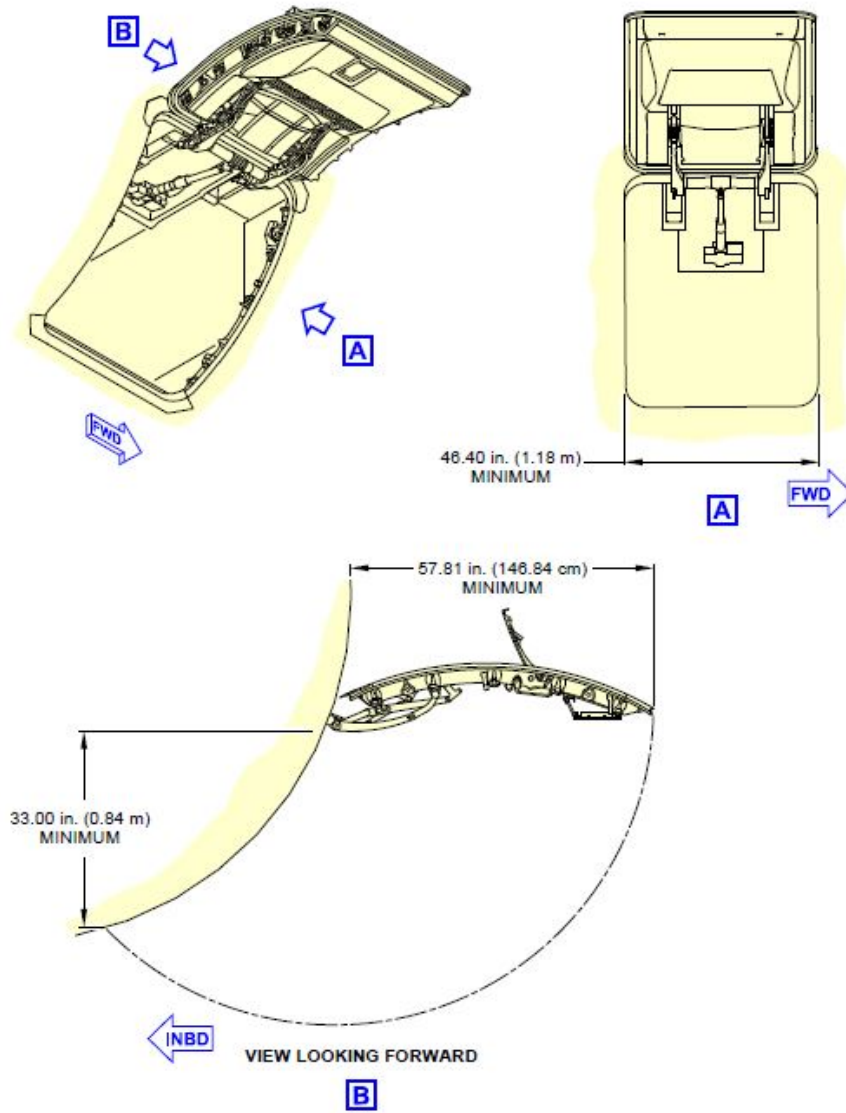

**MAXIMUM DIMENSIONS FOR CONVENTIONAL LOADS
IN FORWARD HOLD 1**

Width (m)	Height (m)									
	0 to 0.304	0.304 to 0.508	0.508 to 0.584	0.584 to 0.635	0.635 to 0.685	0.685 to 0.736	0.736 to 0.762	0.762 to 0.787	0.787 to 0.812	0.812 to 0.838
Maximum package length (m)										
0 to 0.076	3.708	3.708	3.708		3.632	3.175	2.946	2.743	2.489	2.209
0.076 to 0.152				3.708	3.378	2.971	2.768	2.565	2.336	2.108
0.152 to 0.228				3.505	3.149	2.794	2.590	2.438	2.235	2.006
0.228 to 0.304			3.556	3.251	2.946	2.641	2.463	2.311	2.108	1.905
0.304 to 0.381			3.327	3.048	2.768	2.489	2.336	2.209	2.032	1.828
0.381 to 0.457			3.454	3.124	2.870	2.641	2.362	2.235	2.108	1.930
0.457 to 0.533	3.556	3.225	2.946	2.717	2.514	2.260	2.133	2.006	1.854	1.676
0.533 to 0.609	3.327	3.022	2.794	2.590	2.387	2.159	2.032	1.930	1.778	1.600
0.609 to 0.685	3.124	2.870	2.641	2.489	2.286	2.082	1.955	1.854	1.727	1.549
0.685 to 0.762	2.971	2.717	2.540	2.362	2.184	2.006	1.879	1.778	1.651	1.498
0.762 to 0.838	2.819	2.616	2.438	2.286	2.108	1.930	1.803	1.727	1.574	1.422
0.838 to 0.914	2.692	2.489	2.336	2.184	2.038	1.854	1.752	1.651	1.524	1.371
0.914 to 0.990	2.565	2.387	2.235	2.108	1.955	1.778	1.676	1.574	1.447	1.295
0.990 to 1.066	2.463	2.286	2.159	2.006	1.854	1.676	1.574	1.473	1.346	1.193
1.066 to 1.168	2.159	1.955	1.803	1.651	1.498	1.320	1.193	1.117	0.965	0.838
<p>CAUTION: – If the package is loaded in the forward section of the forward cargo compartment, the maximum length is limited to 1.778 m.</p> <p>NOTE: Example: The maximum length for a package with a width of 0.760 m and a height of 0.630 m is 2.362 m.</p>										

**MAXIMUM DIMENSIONS FOR CONVENTIONAL LOADS
IN FWD SECTION OF AFT HOLD 4**

Width (m)	Height (m)									
	0 to 0.304	0.304 to 0.508	0.508 to 0.584	0.584 to 0.635	0.635 to 0.685	0.685 to 0.736	0.736 to 0.762	0.762 to 0.787	0.787 to 0.812	0.812 to 0.838
Maximum package length (m)										
0 to 0.076	3.225	3.225	3.225	3.225	3.225	3.175	2.946	2.743	2.489	2.209
0.076 to 0.152						2.971	2.768	2.565	2.336	2.108
0.152 to 0.228					3.149	2.794	2.590	2.438	2.235	2.006
0.228 to 0.304					2.946	2.641	2.463	2.311	2.108	1.905
0.304 to 0.381			3.048	2.768	2.489	2.336	2.209	2.032	1.828	
0.381 to 0.457			3.124	2.870	2.641	2.362	2.235	2.108	1.930	1.752
0.457 to 0.533			2.946	2.717	2.514	2.260	2.133	2.006	1.854	1.676
0.533 to 0.609			3.022	2.794	2.590	2.387	2.159	2.032	1.930	1.778
0.609 to 0.685	3.124	2.870	2.641	2.489	2.286	2.082	1.955	1.854	1.727	1.549
0.685 to 0.762	2.971	2.717	2.540	2.362	2.184	2.006	1.879	1.778	1.651	1.498
0.762 to 0.838	2.819	2.616	2.438	2.286	2.108	1.930	1.803	1.727	1.574	1.422
0.838 to 0.914	2.692	2.489	2.336	2.184	2.038	1.854	1.752	1.651	1.524	1.371
0.914 to 0.990	2.565	2.387	2.235	2.108	1.955	1.778	1.676	1.574	1.447	1.295
0.990 to 1.066	2.463	2.286	2.159	2.006	1.854	1.676	1.574	1.473	1.346	1.193
1.066 to 1.168	2.159	1.955	1.803	1.651	1.498	1.320	1.193	1.117	0.965	0.838

NOTE: Example: The maximum length for a package with a width of 0.760 m and a height of 0.630 m is 2.362 m.

**MAXIMUM DIMENSIONS FOR CONVENTIONAL LOADS
IN AFT SECTION OF AFT HOLD 4**

Width (m)	Height (m)									
	0 to 0.304	0.304 to 0.508	0.508 to 0.584	0.584 to 0.635	0.635 to 0.685	0.685 to 0.736	0.736 to 0.762	0.762 to 0.787	0.787 to 0.812	0.812 to 0.838
	Maximum package length (m)									
0 to 0.076	4.064	4.064	4.064	3.886	3.454	3.048	2.819	2.667	2.413	2.184
0.076 to 0.152			3.962	3.556	3.200	2.844	2.692	2.514	2.311	2.057
0.152 to 0.228			3.632	3.327	3.022	2.717	2.540	2.413	2.184	2.006
0.228 to 0.304			3.810	3.403	3.149	2.844	2.565	2.438	2.286	2.082
0.304 to 0.381	3.962	3.556	3.225	2.946	2.717	2.438	2.311	2.159	1.981	1.828
0.381 to 0.457	3.657	3.302	3.022	2.819	2.565	2.336	2.209	2.082	1.930	1.752
0.457 to 0.533	3.429	3.124	2.844	2.667	2.438	2.235	2.108	2.006	1.854	1.676
0.533 to 0.609	3.225	2.946	2.717	2.540	2.362	2.133	2.006	1.930	1.778	1.600
0.609 to 0.685	3.048	2.819	2.590	2.413	2.260	2.057	1.955	1.854	1.727	1.549
0.685 to 0.762	2.870	2.667	2.463	2.336	2.159	2.006	1.879	1.778	1.651	1.498
0.762 to 0.838	2.768	2.540	2.387	2.260	2.082	1.930	1.803	1.727	1.574	1.422
0.838 to 0.914	2.616	2.438	2.311	2.159	2.006	1.854	1.752	1.651	1.524	1.371
0.914 to 0.990	2.514	2.362	2.209	2.082	1.955	1.778	1.676	1.574	1.447	1.295
0.990 to 1.066	2.438	2.260	2.108	2.006	1.854	1.676	1.574	1.473	1.346	1.193
1.066 to 1.168	2.133	1.955	1.803	1.651	1.498	1.320	1.193	1.117	0.965	0.838
<p>CAUTION: If the package sits on the canted floor, validate that the load distribution do not exceed the floor capacity.</p> <p>NOTE: Example: The maximum length for a package with a width of 0.760 m and a height of 0.630 m is 2.336 m.</p>										

 Volume II HLM	INFORMATION PER AIRCRAFT TYPE	5.8	Pag. 14
	A220 100 - ITA	Ed 2 Rev 5/02 nov 23	

5.8.2 Cargo doors opening

The control panel for the cargo door (fwd and aft) functioning is used to activate the actuators for the opening and closing of fwd and aft cargo compartments doors. The panel consists of three buttons. Two are needed to lift and lower the door, the third to switch on the loading area lights (LAL). Includes the following switches:

OPEN switch

a green button, marked with an arrow pointed upwards, allows the ground personnel to open the cargo compartment door.

CLOSE switch

a red button, marked with an arrow pointed downward allows the ground personnel to close the cargo compartment door.

LIGHT switch

a yellow button, used to turn on the LAL of the respective cargo compartment door.

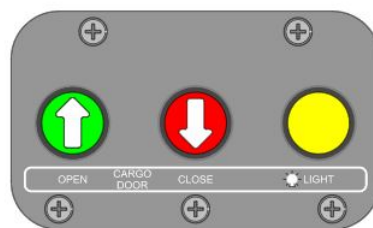
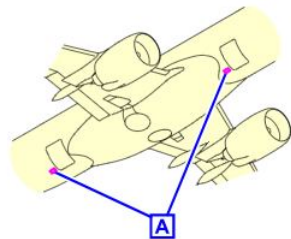

CARGO COMPARTMENT DOOR
ACTUATOR CONTROL PANEL

A

It is forbidden to activate or leave the doors opened when wind is more than 40 knots.

 Volume II HLM	INFORMATION PER AIRCRAFT TYPE	5.8	Pag. 15
	A220 100 - ITA	Ed 2 Rev 5/02 nov 23	

5.8.3 FUEL

The aircraft has three tanks. Below is a table of capacity (average reference density of 0.809 kg/lit).

	PESO Kg	VOLUME Lt
LEFT WING TANK	3080	3807
RIGHT WING TANK	3080	3807
CENTER TANK	11480	14190
TOTAL	17640	21805

 ITA AIRWAYS Volume II HLM	INFORMATION PER AIRCRAFT TYPE	5.8	Pag. 16
	A220 100 - ITA	Ed 2 Rev 5/02 nov 23	

5.8.4 USE OF MARKER CONES

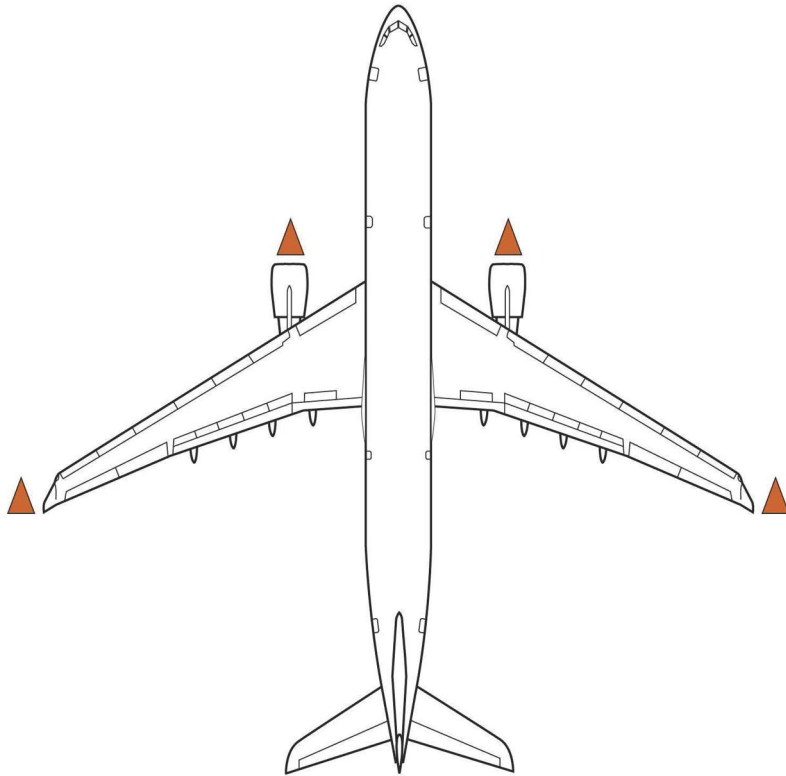

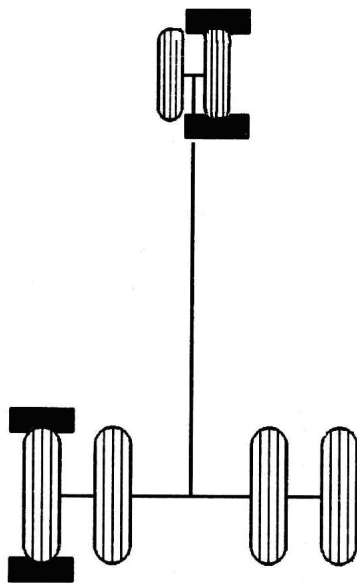

5.8.5 CHOCKING OF AIRCRAFT

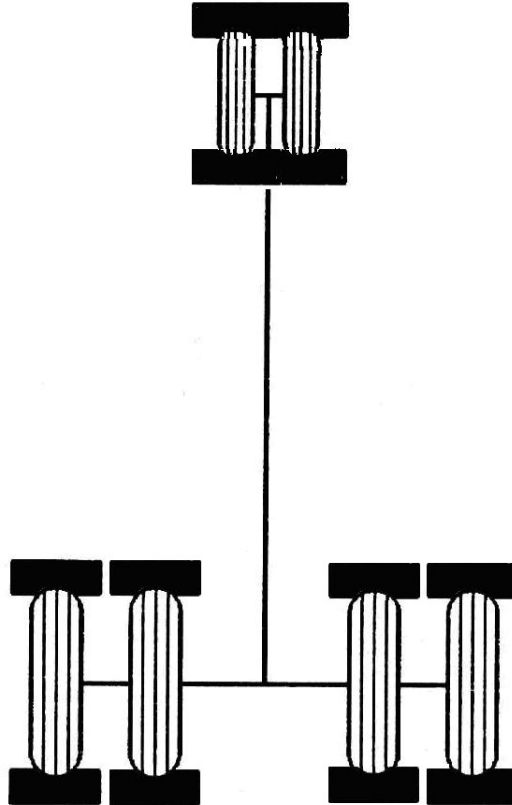

 Volume II HLM	INFORMATION PER AIRCRAFT TYPE	5.8	Pag. 17
	A220 100 - ITA	Ed 2 Rev 5/02 nov 23	

5.8.6 Chocking of aircraft with wind over 25kt (46.3 km/h)



 ITA AIRWAYS Volume II HLM	INFORMATION PER AIRCRAFT TYPE	5.8	Pag. 18
	A220 100 - ITA	Ed 2 Rev 5/02 nov 23	

5.8.7 TOILETTE DRAIN

Below is the procedure for draining, rinsing and refilling disinfected water:

1. Open the service panel.
2. Open the drain valve cover.
3. Connect the drainage pipe and ensure it is well connected. Lower the reed valve actuator 90 degrees to allow the drain valve to open.
4. Proceed with drainage according to the type of GSE used.
5. When draining, ensure that the liquid drains from the pipe

Note: If the drainage does not drain properly, inform a company representative.

6. Connect the rinse hose to the service panel rinse fit.
7. Rinse the waste tank with 75 liters (no less than 50 liters) of disinfected fluid for 2,5 minutes (no less than 2), pressure shall be between 25 and 60 PSI.
8. Make sure that there is no fluid flow in the drain hose.
9. Move the actuation lever to 90 degrees up to close the drain valve.
10. Disconnect the drain hose from the drain valve.
11. Add 7,5 liters of precharge fluid.

Note: In case of leakage from the drain valve inform immediately a Company representative.

11. Disconnect the rinse hose from the rinse fittings.
12. Close the rinse fitting cap.
13. Clean the inner and external surfaces of the waste servicing area with a dry cloth.

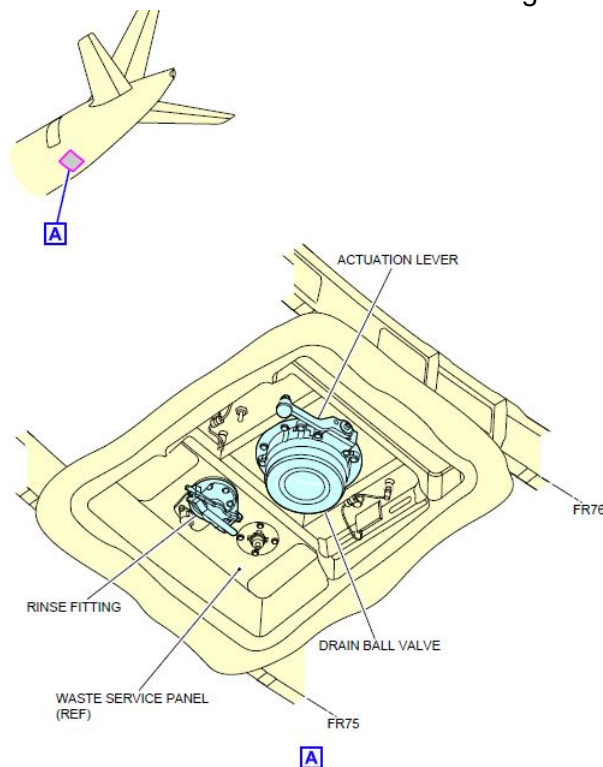

 Volume II HLM	INFORMATION PER AIRCRAFT TYPE	5.8	Pag. 19
	A220 100 - ITA	Ed 2 Rev 5/02 nov 23	

5.8.8 FILLING POTABLE WATER

Following, procedure for potable water supply operation:

1. If refuelling is carried out without the aid of the CMS (Cabin management System), proceed from point 4
2. Access the CMS screen in the cabin and select LAVATORY
3. Pre-select the amount of water to be supplied (10% increments can be entered)
4. Open the service panel door.
5. Connect the fill hose to the filling valve.
6. Set the FILL/DRAIN switch to the FILL position.
7. On the potable water cart open the water supply valve and make sure that the fill pressure is at 25 to 60 psi.
7. When the water fill process is completed, make sure that the FULL light comes on the water level indicator.
8. Make sure that the CMS shows the correct water level value which is set.
9. Close the water supply valve.
10. Disconnect the fill hose from the fill nipple and completely let the water purge from the fill nipple for approximately 3 minutes.
11. Close the fill nipple valve and set the FILL/DRAIN switch to FLIGHT

Note: In case of leakage from the drain valve inform immediately a Company representative..

Note: With temperatures close to or below 0 °C, make sure that the residual water is completely drained before replacing the cap.

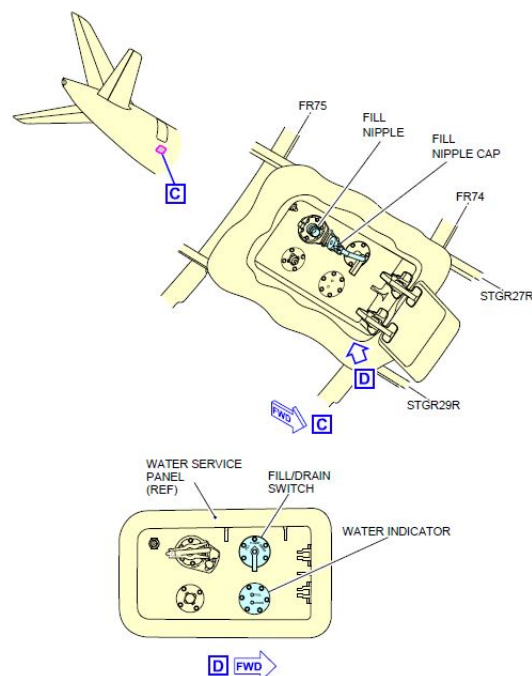



Nota: The standard quantity of water to be supplied is 60%.

 Volume II HLM	INFORMATION PER AIRCRAFT TYPE	5.8	Pag. 20
	A220 100 - ITA	Ed 2 Rev 5/02 nov 23	

5.8.9 BULK HOLDS LOADING/UNLOADING ASSISTANCE

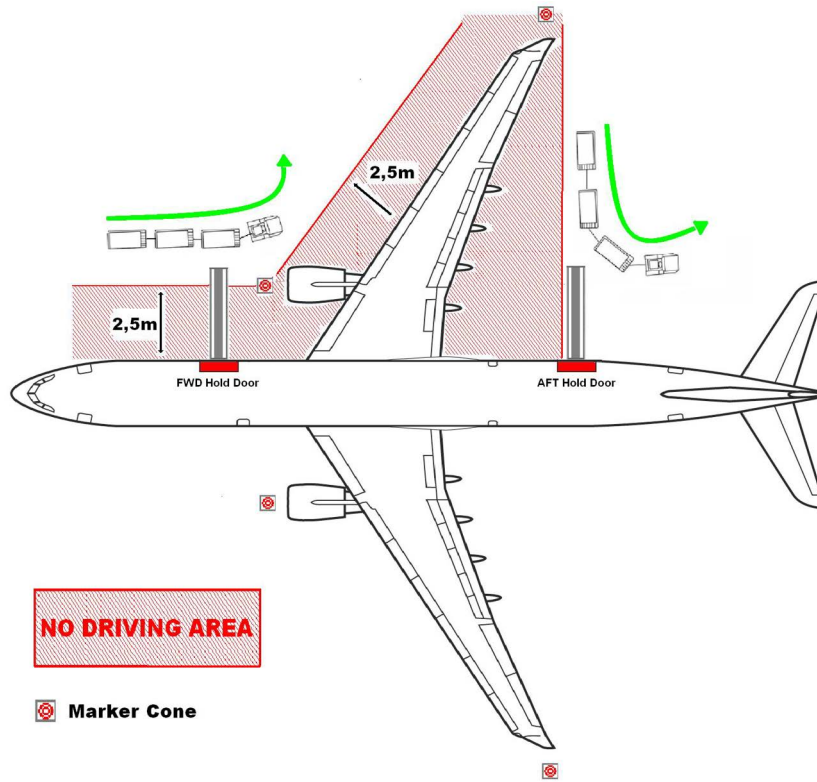
Only belt loaders are allowed for loading/unloading.



 ITA AIRWAYS Volume II HLM	INFORMATION PER AIRCRAFT TYPE	5.8	Pag. 21
	A220 100 - ITA	Ed 2 Rev 5/02 nov 23	

5.8.10 PRE DEPARTURE SERVICING CHECK LIST

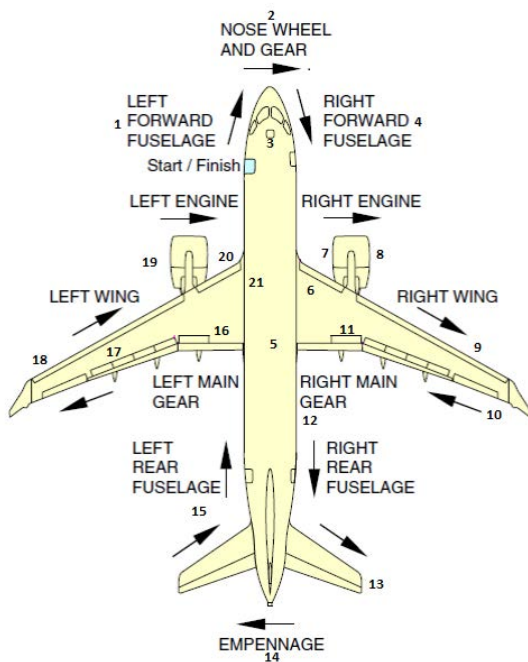

Predeparture Servicing Check List A220		
N°	Aircraft section	Action (*)
1	left fwd fuselage	<i>condition</i>
	left fwd passengers door	<i>closed</i>
2	pitot-static tubes	<i>condition</i>
	static port	<i>clear</i>
	ground power access door panel	<i>closed</i>
3	nose gear chocks (**) <i>removed</i>	<i>positioned</i>
	or	
	push back track wheels and tires	<i>connected</i> <i>condition</i>
	Hydraulic Safety Pin	<i>connected (push back) or removed (power out)</i>
4	right fwd fuselage	<i>condition</i>
	right fwd passenger door	<i>closed and checked</i>
	right fwd cargo door	<i>closed and checked</i>
5	central fuselage	<i>condition</i>
	potable water access panel	<i>closed</i>
	LP e HP connection access	<i>closed</i>
	anticollision light (beacon)	<i>on</i>
6/9/10	right wing	<i>condition</i>
	fuel panel	<i>closed</i>
7/8	right wing	<i>condition</i>
11	landing gear chocks (**) <i>removed</i>	<i>removed</i>
	wheels and tires	<i>condition</i>
12	right rear fuselage	<i>condition</i>
	right rear cargo door	<i>closed and checked</i>
	right rear passenger door	<i>closed and checked</i>
	bulk door	<i>closed and checked</i>
	waste service panel	<i>closed</i>
13	empennage	<i>condition</i>
14	exhaust	<i>clear</i>
15	left rear fuselage	<i>condition</i>
	left rear passengers dor	<i>closed and checked</i>
	potable water panel	<i>closed</i>
16	left landing gear chocks (**) <i>removed</i>	<i>removed</i>
	wheels and tires	<i>condition</i>
17/18/21	left wing	<i>condition</i>
19/20	left engine	<i>condition</i>
(*)The term <i>condition</i> means that the following items have been verified: obvious damage, obvious liquid leakage and handles flush with the fuselage.		
(**) the ground personnel must ensure that parking brakes have been set prior to removal		

 ITA AIRWAYS Volume II HLM	INFORMATION PER AIRCRAFT TYPE	5.8	Pag. 22
	A220 100 - ITA	Ed 2 Rev 5/02 nov 23	

5.8.11 SAFETY AREAS

5.8.11.1 Idle thrust - Intake and Blast Areas

Intake and Blast areas when aircraft on idle thrust shall be observed and neither personnel or equipment shall be positioned inside such areas when engines are running.

Blast areas are referred to the back of the aircraft, starting from the back edge of the running engine.

Safety distance shown in the following table shall be observed.

IDLE THRUST (Danger areas lenght)		
- A - INTAKE AREA	- B -	- C - BLAST AREA
idle 2.74 m take-off power 6.1 m	corridor	idle 61 m take-off power 145 m

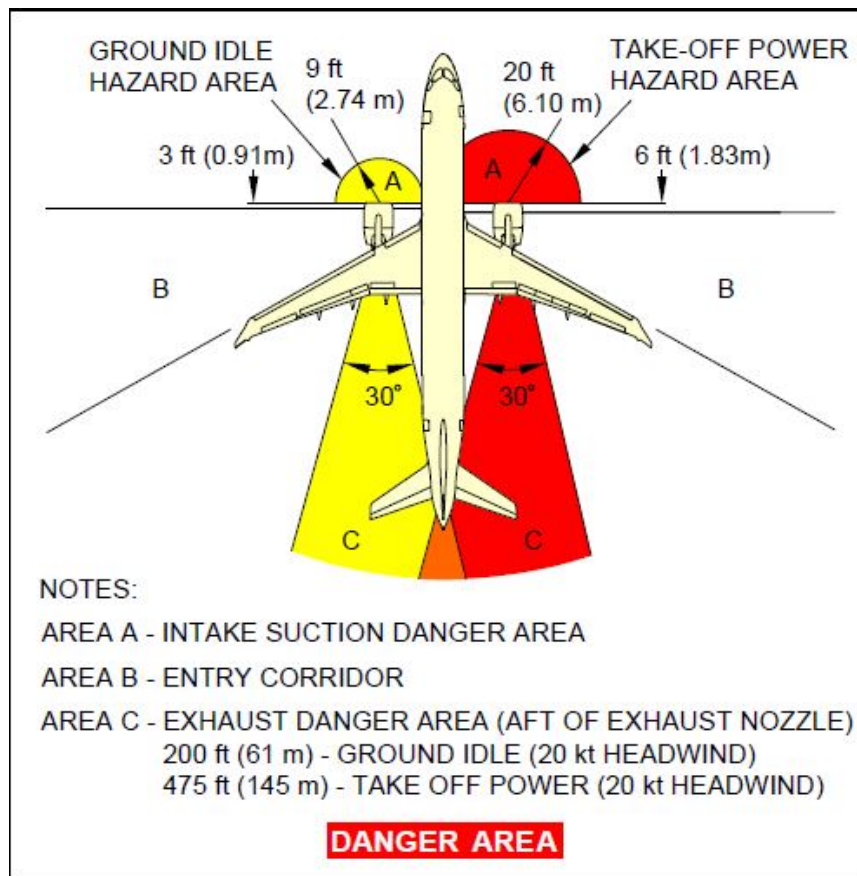

5.8.12 SERVICING ARRANGEMENTS

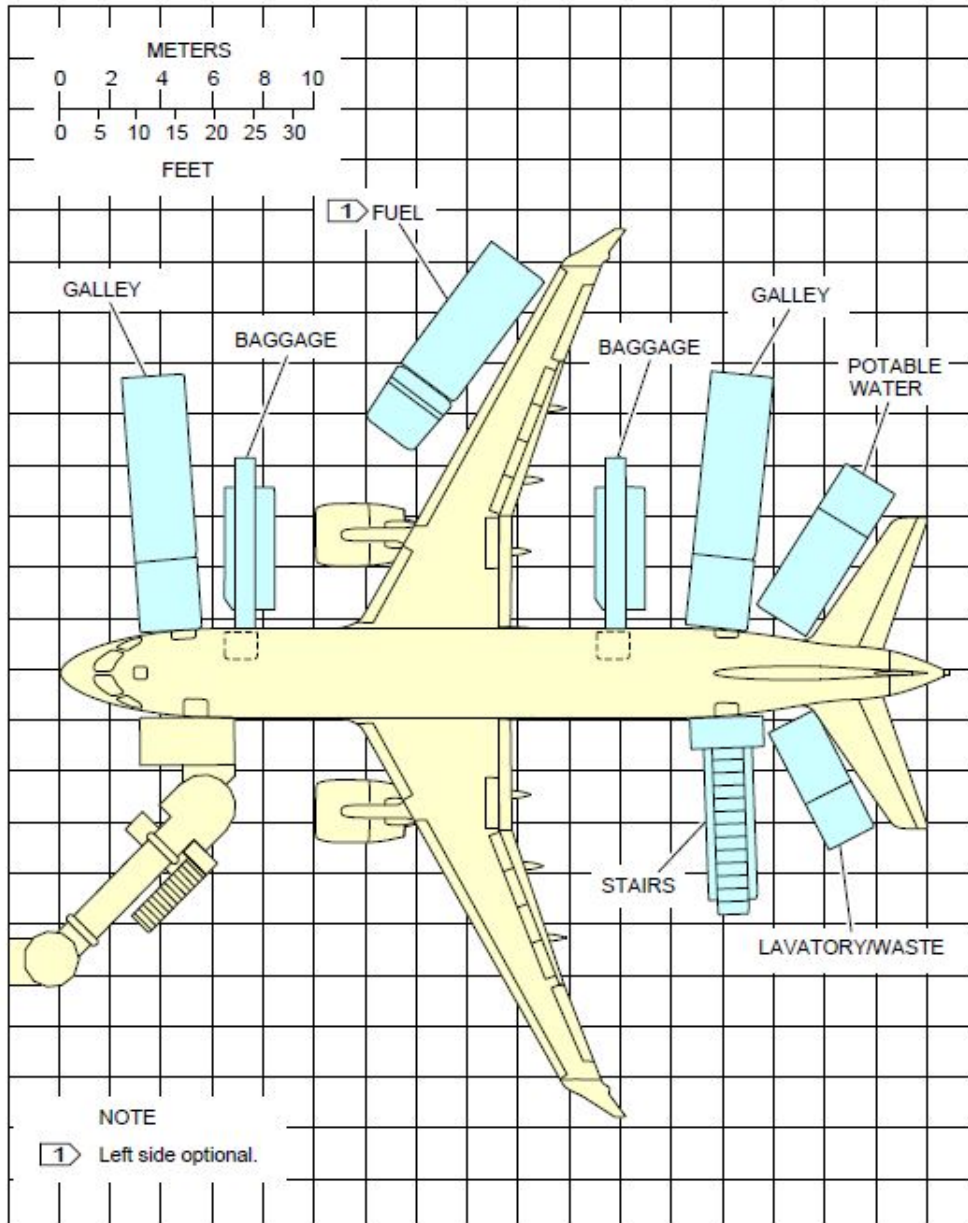

5.8.13 Steering limits

turning angle in degree	turning center to center line	nose tipè	nose geare	main gear	wing tip	empennage tip	Minimum theoretical pavement width for 180 degrees turn
17	42845 mm	49910 mm	45118 mm	46878 mm	60589 mm	51986 mm	91996 mm
27	25707 mm	30549 mm	29169 mm	29743 mm	43561 mm	36325 mm	58913 mm
37	17384 mm	23967 mm	22080 mm	21417 mm	35326 mm	29317 mm	43500 mm
47	12215 mm	20531 mm	18227 mm	16251 mm	30241 mm	25372 mm	34475 mm
57	8506 mm	18565 mm	15949 mm	12527 mm	26609 mm	22842 mm	28476 mm
67	5560 mm	17412 mm	14547 mm	9596 mm	23741 mm	21085 mm	24140 mm
77	3025 mm	16774 mm	13759 mm	7059 mm	21290 mm	19797 mm	20818 mm

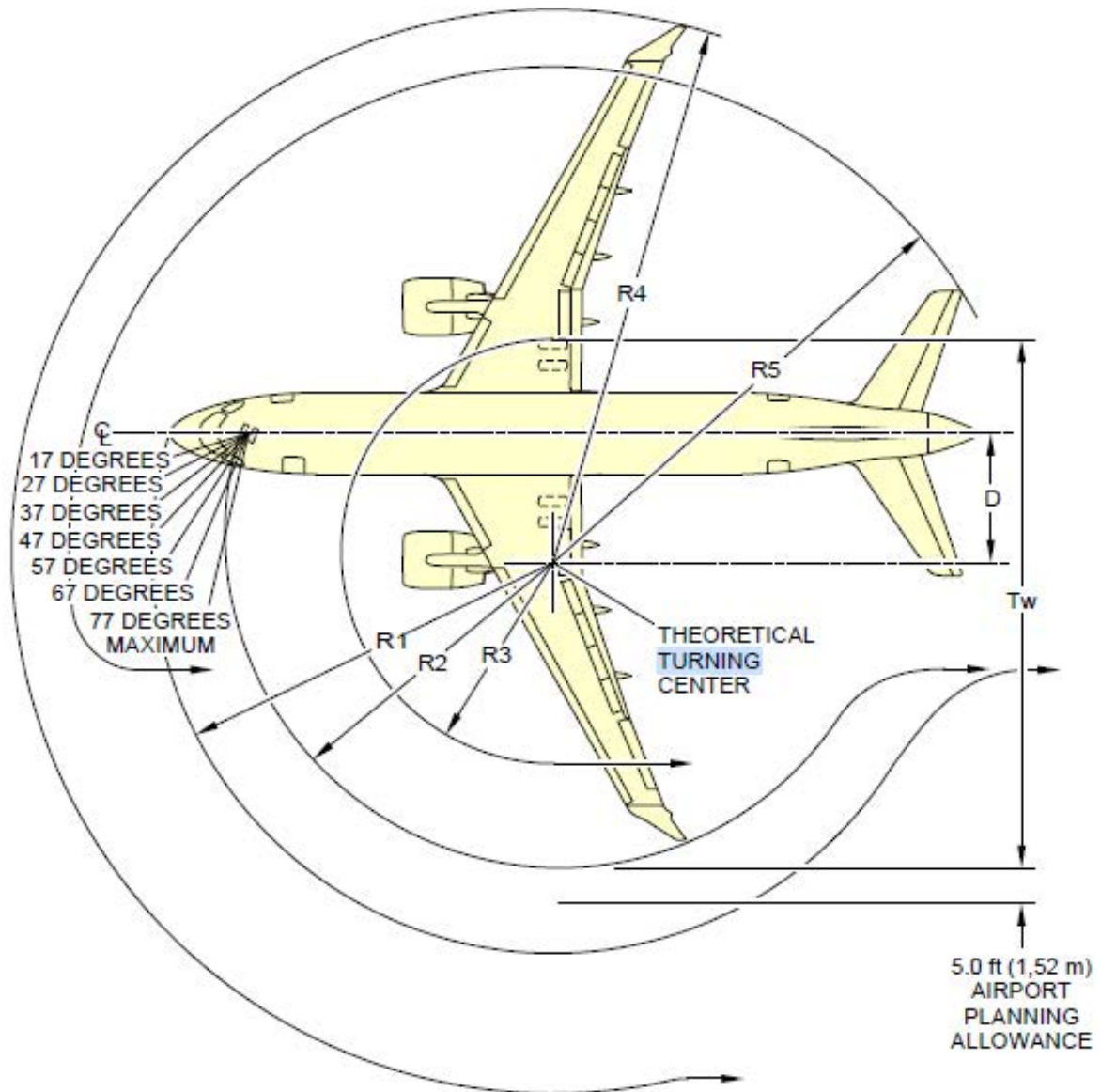

UNIT LOAD DEVICE (ULD)

 Volume II HLM	UNIT LOAD DEVICE	6.1	Page 1
	GENERAL CHARACTERISTICS	Ed 2/20 apr 2022	

6.1 GENERAL CHARACTERISTICS

6.1.1 INTRODUCTION

Dead load (baggage and/or cargo) can be pre-assembled in groups, particularly for practical reasons, using Unit Load Devices (ULD).

The Unit Load Device is loadable on board containerized aircraft which is part of the actual system of loading and restraint of the aircraft itself and which fulfil all restraint requirements without the use of supplementary equipment. As such it is considered component parts of the aircraft (as long as it is functioning and correctly positioned on board).

The ULD is a platform (pallet) or container on which or in which load is placed; the unit may either consist in a combination of components or in a complete structural unit. For example, a combined unit is formed by an aircraft pallet plus a net and non-structural igloo, or by a pallet plus net.

Unit Load Devices which have been designed and built to resist to certain conditions, may be tested and then certified by the Government Authorities of the Country of origin or of the Company which uses them.

According to the NAS (*National Aerospace Standard*), depending on the maximum certified restraint capacity, exists an other classification as described in the following table:

Class	Restraint capacity
Class I	9G
Class II	3G

A mixed system (Class I pallets with a Class II net, or vice-versa) only satisfies the 3G factors and falls, therefore, in Class II; on the other hand, a Class I load unit placed in compartments with inferior restraint equipment (such as those of AITALIA A/C) is in any case considered as Class II for practical purposes.

For this reason ALL the units used on ITA A/C belong to Class II.

6.1.2 ID - CODE

All Unit Load Devices, registered with IATA, must bear the ID CODE assigned to them. The complete code is formed at present by nine or ten alphanumerical characters; the following is an example:

AKE - 12345 XX

that is:

- **AKE** identifies type, base dimensions and compatibility with holds of ULD,
- **12345** identifies serial number of ULD,
- **XX** identifies owner carrier code of ULD.

6.1.3 TECHNICAL INFORMATION

6.1.3.1 AKE Container (made of composite material)

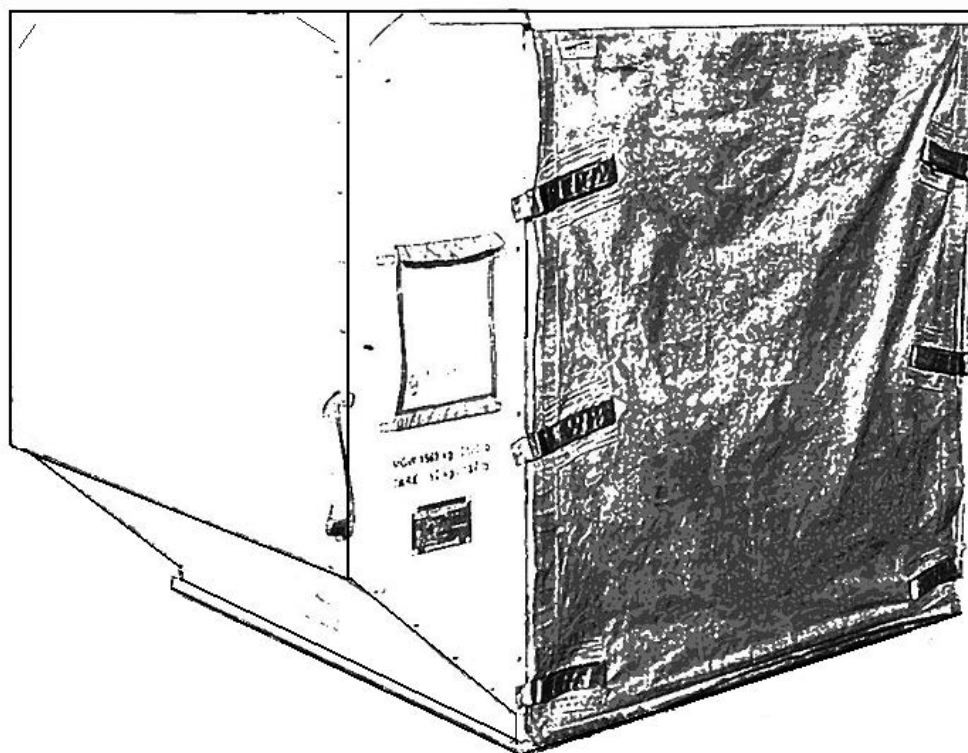

IATA CODE	AKE
DCS ITA CODE	AKL
DIMENSIONS	60,4" x 61,5" x 64,0" / 153,4 x 156,2 x 162,6 cm
MAX STRUCTURAL LOAD	3.500 lb - 1.588 kg
TARE	139 lb - 63 kg
NET ALLOWED WEIGHT	3.355 lb - 1.525 kg
MAX SURFACE LOAD	907 kg/m ²
VOLUME	4,3 m ³
MAY BE LOADED ON:	A330 - A350

6.1.3.2 AKH & AKH light weight container

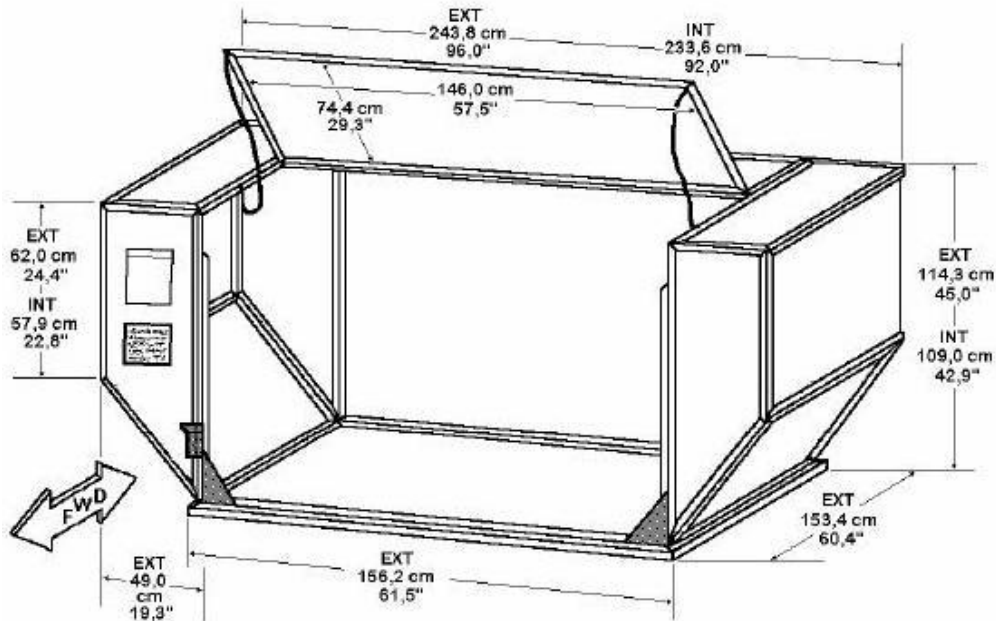

Characteristics of door and free floor	
Front DOOR	WIDE = 55,9" - 142,0 cm HIGH = 41,3" - 104,9 cm
Upper DOOR	WIDE = 57,5" - 146,0 cm HIGH = 29,3" - 74,4 cm
FREE FLOOR	WIDE = 52,7" - 133,8 cm LONG = 51,6" - 131,0 cm HIGH = 42,9" - 109,0 cm
Door Central portion, free by triangular plates	WIDE = 52,3" - 132,8 cm HIGH = 36,2" - 92,0 cm

IATA CODE	AKH
DCS ITA CODE	AKH
DIMENSIONS	60,4" x 61,5" x 45,0" / 153,4 x 156,2 x 114,3 cm
MAX STRUCTURAL LOAD	3.500 lb - 1.587 kg
TARE	Alloy 180 lb - 82 kg / 167 lb - 76 kg/ Light weight 130 lb - 59 kg
NET ALLOWED WEIGHT	3.320 lb - 1.505 kg
MAX SURFACE LOAD	907 kg/m ²
VOLUME	3,7 m ³
MAY BE LOADED ON:	A320 - A321

 Volume II HLM	UNIT LOAD DEVICE	6.1	Page 4
	GENERAL CHARACTERISTICS	Ed 2/20 apr 2022	

6.1.3.3 PAG - P1P Pallet



IATA CODE	PAG - P1P
DCS ITA CODE	PAG (HEIGHT 64")
DIMENSIONS	88,0" x 125,0" x 64,0" / 223,5 x 317,5 x 162,6 cm
USABLE AREA OF BASE	83,0" x 120" / 211,0 x 305 cm
MAX STRUCTURAL LOAD	13.300 lb - 6.033 kg
TARE	249 lb - 113 kg
NET ALLOWED WEIGHT	13.024 lb - 5.920 kg
MAX SURFACE LOAD	1.465 kg/m ²
VOLUME	10,1 m ³ (con HEIGHT 64")
MAY BE LOADED ON:	A330 - A350

 Volume II HLM	UNIT LOAD DEVICE	6.1	Page 5
	GENERAL CHARACTERISTICS	Ed 2/20 apr 2022	

6.1.3.4 PMC - P6P - PMA Pallet



IATA CODE	PMA - P6P - PMC
DCS ITA CODE	PMC (HEIGHT 64")
DIMENSIONS	96,0" x 125,0" x 64,0" / 243,8 x 317,5 x 162,6 cm
USABLE AREA OF BASE	91,0" x 120,0" / 231,1 x 304,8 cm
MAX STRUCTURAL LOAD	15.000 lb - 6.804 kg
TARE	273 lb - 124 kg
NET ALLOWED WEIGHT	14.696 lb - 6.680 kg
MAX SURFACE LOAD	1.465 kg/m ²
VOLUME	11,5 m ³ (con HEIGHT 64")
MAY BE LOADED ON:	A330 - A350

 Volume II HLM	UNIT LOAD DEVICE	6.1	Page 6
	GENERAL CHARACTERISTICS	Ed 2 Rev 6/15 nov 23	

6.1.3.5 PKC Pallet



IATA CODE	PKC
DCS ITA CODE	PKC (HEIGHT 45"/64")
DIMENSIONS	60,4" x 61,5" x 45,0" - 153,4 x 156,2 x 114,3 cm
USABLE AREA OF BASE	55,4" x 56,4" / 140,7 x 143,2 cm
MAX STRUCTURAL LOAD	3.500 lb - 1.587 kg
TARE	88 lb - 40 kg
NET ALLOWED WEIGHT	3.412 lb - 1.547 kg
MAX SURFACE LOAD	907 kg/m ²
VOLUME	2,5 m ³ (HEIGHT 45") / 3,2 m ³ (HEIGHT 64")
MAY BE LOADED ON:	A321 - A320 - A330 - A350

 Volume II HLM	UNIT LOAD DEVICE	6.1	Page 7
	GENERAL CHARACTERISTICS	Ed 2 Rev 3/26 may 23	

6.1.3.6 PLA Pallet

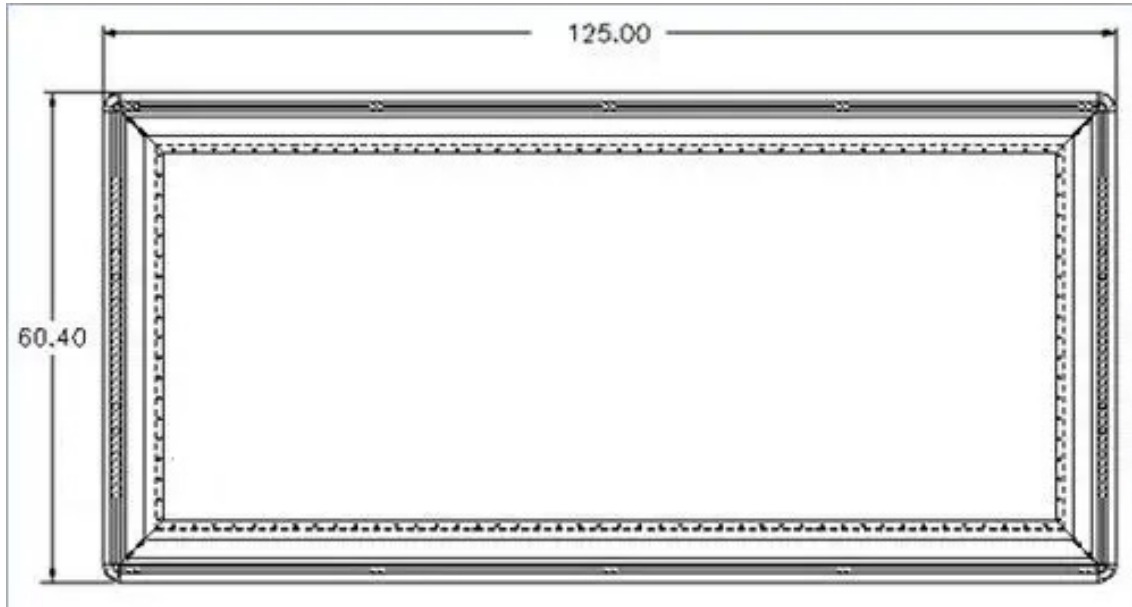

IATA CODE	PLA
DCS ITA CODE	PLA (HEIGHT 64")
DIMENSIONS	60,4" x 125,0" x 64,0"- 153,4 x 317,5 x 162,6 cm
USABLE AREA OF BASE	54,0" x 118,0" 136,0 x 300,0 cm
MAX STRUCTURAL LOAD	7.000 lb - 3.175 kg
TARE	190 lb - 84 kg / 173 lb - 124 kg
NET ALLOWED WEIGHT	7.348 lb - 3.340 kg
MAX SURFACE LOAD	732 kg/m ²
VOLUME	6,6 m ³ (con HEIGHT 64")
MAY BE LOADED ON:	A330 - A350

 Volume II HLM	UNIT LOAD DEVICE	6.1	Page 8
	GENERAL CHARACTERISTICS	Ed 2/20 apr 2022	

6.1.3.7 AAP Container

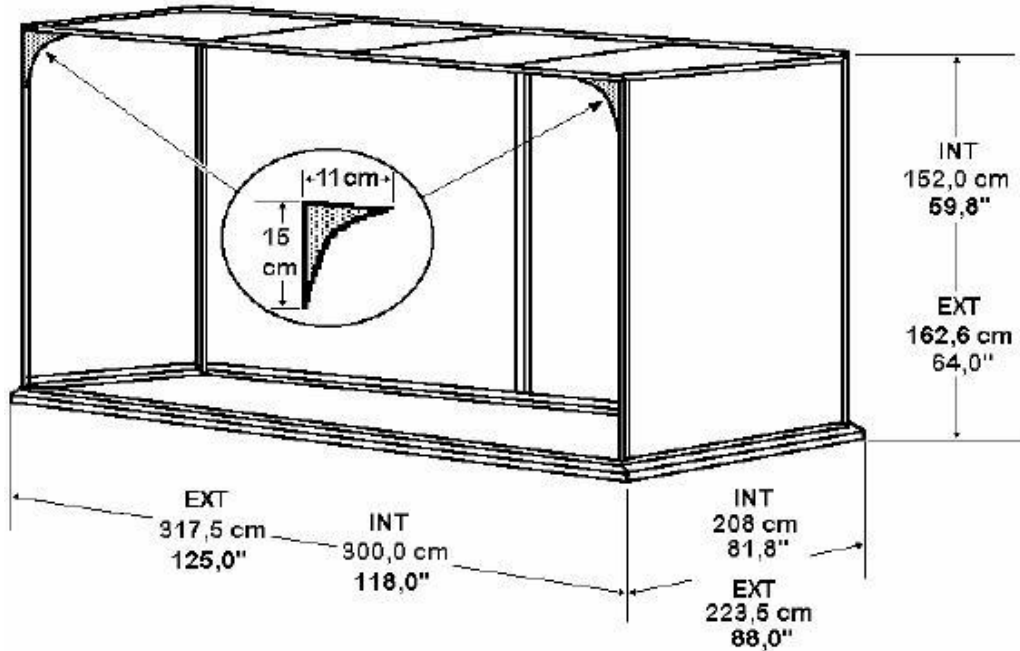

Characteristics of door and free floor	
DOOR	LOWER WIDTH 113,3" / 288,0 cm UP TO HEIGHT 53,5" / 136,0 cm UPPER WIDTH 104,7" / 266,0 cm FROM HEIGHT 57,8" / 147,0 cm
FREE FLOOR	118,1" / 300,0 cm WIDE 81,8" / 208,0 cm LONG 59,8" / 152,0 cm HIGH

IATA CODE	AAP
DCS ITA CODE	AAP
DIMENSIONS	88,0" x 125,0" x 64,0" / 223,5 x 317,5 x 162,6 cm
MAX STRUCTURAL LOAD	13.300 lb - 6.033 kg
TARE	465 lb - 211 kg
NET ALLOWED WEIGHT	12.809 lb - 5.822 kg
MAX SURFACE LOAD	1.465 kg/m ²
VOLUME	10,3 m ³
MAY BE LOADED ON:	A330 - A350

 ITA AIRWAYS Volume II HLM	UNIT LOAD DEVICE	6.1	Page 9
	GENERAL CHARACTERISTICS	Ed 2/20 apr 2022	

6.1.3.8 AMP Container

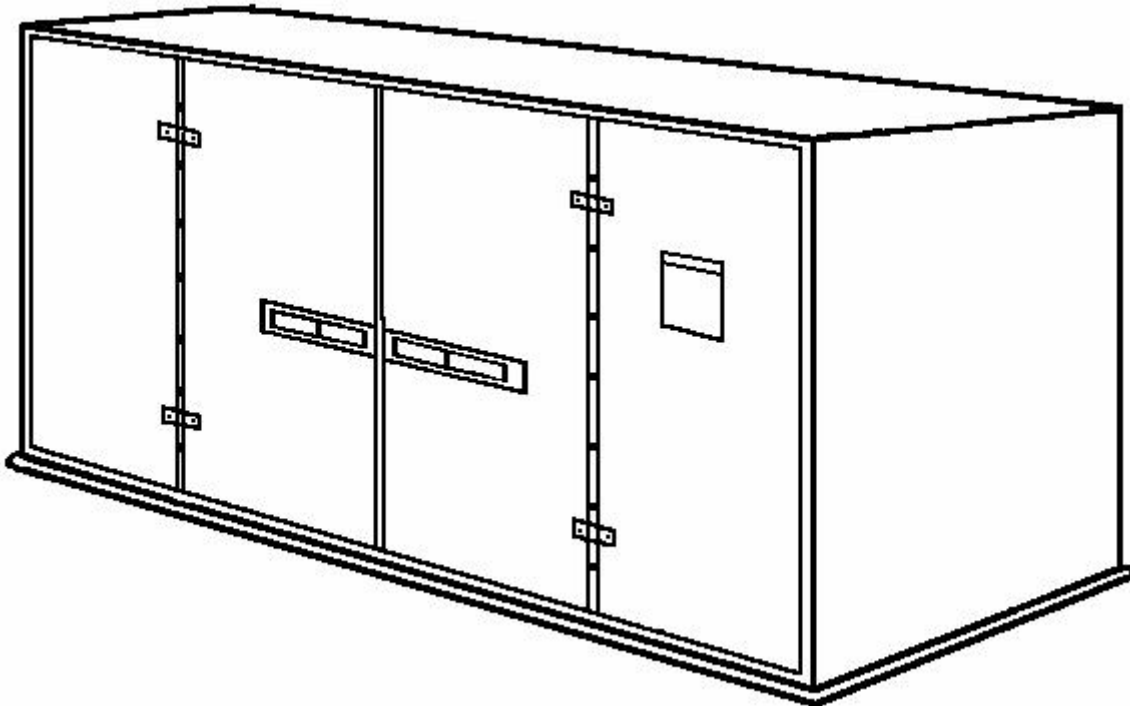

IATA CODE	AMP
DCS ITA CODE	AMP
DIMENSIONS	96,0" x 125,0" x 64,0" / 243,5 x 317,5 x 162,6 cm
MAX STRUCTURAL LOAD	15.000 lb - 6.804 kg
TARE	758 lb - 344 kg
NET ALLOWED WEIGHT	14.242 lb - 6.460 kg
MAX SURFACE LOAD	1.465 kg/m ²
VOLUME	9,7 m ³
MAY BE LOADED ON:	A330 - A350

6.1.3.9 Nets

The nets are used exclusively to restrain the load to the pallet.

The nets' characteristics (type of material, elements, etc.) vary according to the type and/or the manufacturer. However, these guarantee the restraint necessary for the safety of the flight, as long as they are whole and used correctly.

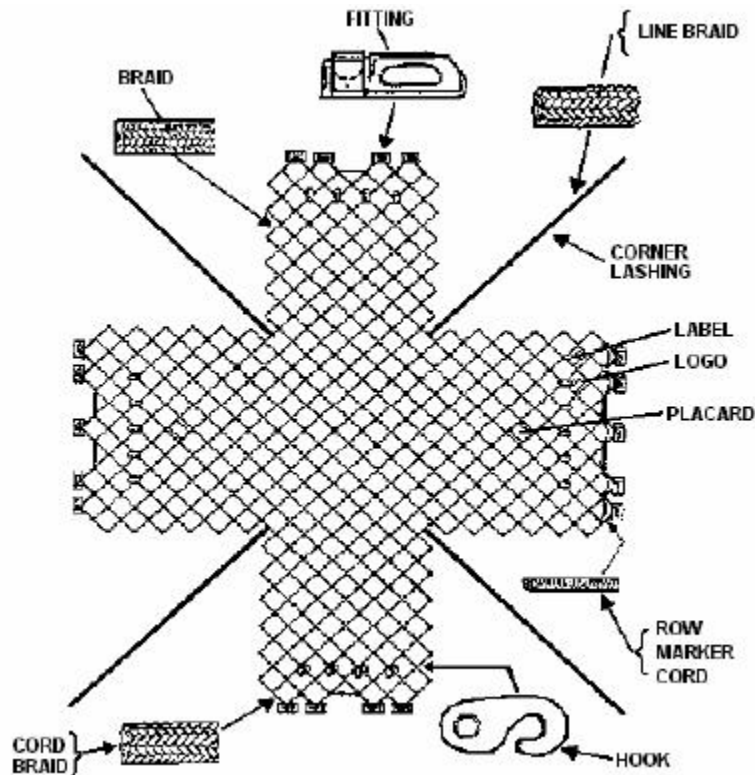

	IATA identification code		
	N1/NA	N6/NM	NK
Characteristics	single-piece, in rope	single-piece, in rope	single-piece, in rope
Unified weight	10 kg	12 kg	6 kg
Type of restraint	Class II	Class II	Class II
Max restrained weight	13.300 lb 6.033 kg	15.000 lb 6.804 kg	3.500 lb 1.587 kg
Used with pallets	PAG - P1P	PAG - P1P PMA - P6P - PMC	PKC

 Volume II HLM	UNIT LOAD DEVICE	6.1	Page 11
	GENERAL CHARACTERISTICS	Ed 2/20 apr 2022	

6.1.3.9.1 Pallet permanent fixed net

Several pallets are equipped with permanent fixed net.

Fixing consists in blocking the net locking studs to a long side of the pallet.

Note:

The net locked is an integration part of the pallet and must not be removed or cut.

If a pallet with the net partially or completely cut is retrieved, the ULD must be operationally managed as UNSERVICEABLE.

The pallet permanent fixed nets are equipped with four (4) flags (see figure) installed in the mesh rows, over the fixed net locking studs.



6.1.3.10 Straps

Straps are used both to restrain special loads (large and/or heavy) to pallets or in the container and are of various kinds: those owned by the Company are 5,000 lb (2,268 kg) straps, 6 m and 8 m in length and 2,000 lb (907 kg) straps, 4.5 m or 6 m in length.

Note: the points of least resistance of the straps (as well as those of the nets) are the hooks. Therefore, by attaching more straps to the same hook the restraint capacity IS NOT INCREASED

6.1.3.11 Tracking devices

Tracking devices are used inside temperature controlled containers (RKN or RAP), ordinary ULD or inside the same shipment to record temperature fluctuation, shocking, humidity, pressure and location during all transport steps.

Presence of the devices will be indicated on the ULD exterior.

In case devices are installed, handle the ULD/shipment carefully in order to ensure the correct device servicing during all transport steps.

Sensor shall be maintained in good and safe conditions.

If sensor might be damaged:

- emissions characteristics may be modified;
- the battery may create a fire hazard.

6.1.3.12 Skycell and Va-Q-Tec Containers on uld

Skycell and Va-Q-Tec containers can be loaded on a uld (pmc or pag) but considered and handled only as package. Before building a pallet it is mandatory to check container conditions, in case of damage it is forbidden to utilize the container as it may cut the net or damage other cargo. Further,

 Volume II HLM	UNIT LOAD DEVICE	6.1	Page 12
	GENERAL CHARACTERISTICS	Ed 2/20 apr 2022	

as they have no rubber support, in case even only one of them is found damaged, it is not allowed their usage.

It is recommended to use only nets to close the pallet as belts may damage structure and rubber support by tension.



SkyCell 1500C



 ITA AIRWAYS Volume II HLM	UNIT LOAD DEVICE	6.1	Page 13
	GENERAL CHARACTERISTICS	Ed 2/20 apr 2022	

6.1.4 Containers for special cargo transportation

Rap Envirotainer container

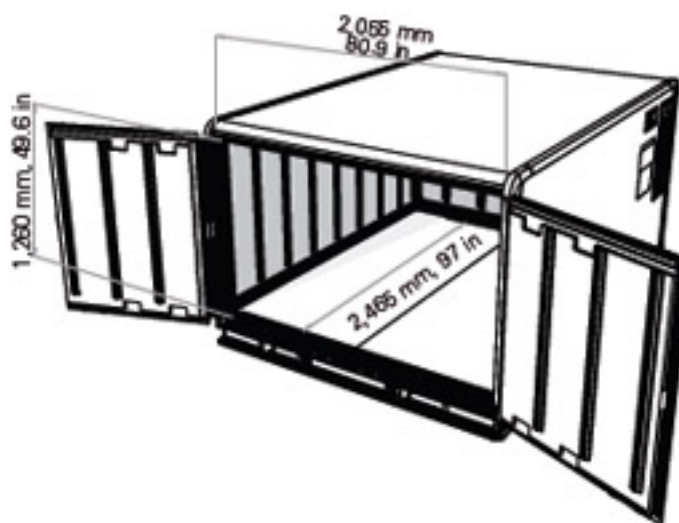

IATA CODE	RAP
DCS IATA CODE	RAP
DIMENSIONS	88,0" x 125,0" x 64,0" / 223,5 x 317,5 x 162,6 cm
MAX STRUCTURAL LOAD	13.300 lb - 6.033 kg
TARE	2425 lb - 1100 kg
ALLOWABLE NET WEIGHT	10.875 lb - 4.933 kg
MAX SURFACE LOAD	1.465 kg/m ²
VOLUME	11,5 m ³
LOADABLE ON:	A330 - A350

 ITA AIRWAYS Volume II HLM	UNIT LOAD DEVICE	6.1	Page 14
	GENERAL CHARACTERISTICS	Ed 2/20 apr 2022	

RKN Envirotainer container

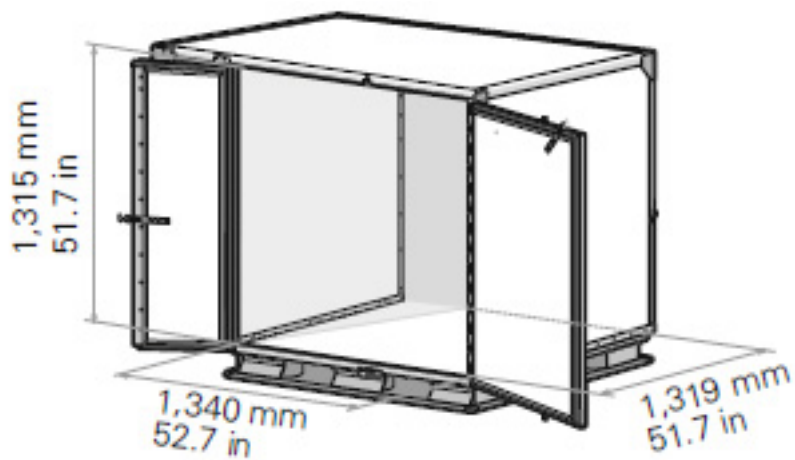

IATA CODE	RKN
DCS ITA CODE	RKN
DIMENSIONS	60,4" x 61,5" x 64,0" / 153,4 x 156,2 x 162,6 cm
MAX STRUCTURAL LOAD	3.500 lb - 1.588 kg
TARE	1400 lb - 635 kg
ALLOWABLE NET WEIGHT	2.101 lb - 953 kg
MAX SURFACE LOAD	907 kg/m ²
VOLUME	4,8 m ³
LOADABLE ON:	A330 - A350

 ITA AIRWAYS Volume II HLM	UNIT LOAD DEVICE	6.1	Page 15
	GENERAL CHARACTERISTICS	Ed 2/20 apr 2022	

RKN Csafe container



IATA CODE	RKN
DCS ITA CODE	RKN 7k
DIMENSIONS	60,4 " x 61,5" x 64,0" / 153,4 x 156,2 x 162,6 cm
MAX STRUCTURAL LOAD	3.500 lb - 1.588 kg
TARE	1380 lb - 626 kg
ALLOWABLE NET WEIGHT	2.120 lb - 962 kg
MAX SURFACE LOAD	907 kg/m ²
VOLUME	4,8 m ³
LOADABLE ON:	A330 - A350

 ITA AIRWAYS Volume II HLM	UNIT LOAD DEVICE	6.1	Page 16
	GENERAL CHARACTERISTICS	Ed 2/20 apr 2022	

Rap Csafe container



IATA CODE	RAP
DCS ITA CODE	RAP 7k
DIMENSIONS	88,0" x 125,0" x 64,0" / 223,5 x 317,5 x 162,6 cm
MAX STRUCTURAL LOAD	13.300 lb - 6.033 kg
TARE	2.675 lb - 1213 kg
ALLOWABLE NET WEIGHT	10.625 lb - 4.819 kg
MAX SURFACE LOAD	1.465 kg/m ²
VOLUME	11,5 m ³
LOADABLE ON:	A330 -A350

 ITA AIRWAYS Volume II HLM	UNIT LOAD DEVICE	6.1	Page 17
	GENERAL CHARACTERISTICS	Ed 2/20 apr 2022	

RKN Dokasch container



IATA CODE	RKN
DCS ITA CODE	RKN 3d
DIMENSIONS	78,8" x 61,5" x 64,0" / 200,2 x 156,2 x 162,6 cm
MAX STRUCTURAL LOAD	3.500 lb - 1.588 kg
TARE	783 lb - 355 kg
ALLOWABLE NET WEIGHT	2.718 lb - 1.233kg
MAX SURFACE LOAD	907 kg/m ²
VOLUME	4,8 m ³
LOADABLE ON:	A330 - A350

 ITA AIRWAYS Volume II HLM	UNIT LOAD DEVICE	6.1	Page 18
	GENERAL CHARACTERISTICS	Ed 2/20 apr 2022	

Rap Dokasch container



IATA CODE	RAP
DCS ITA CODE	RAP 7k
DIMENSIONS	88,0" x 125,0" x 64,0" / 223,5 x 317,5 x 162,6 cm
MAX STRUCTURAL LOAD	13.300 lb - 6.033 kg
TARE	2.514 lb - 1.140 kg
ALLOWABLE NET WEIGHT	10.787 lb - 4.893 kg
MAX SURFACE LOAD	1.465 kg/m ²
VOLUME	11,5 m ³
LOADABLE ON:	A330 - A350

 Volume II HLM	UNIT LOAD DEVICE	6.1	Page 19
	GENERAL CHARACTERISTICS	Ed 2 Rev 10/30 oct 24	

RLP envirotainer container

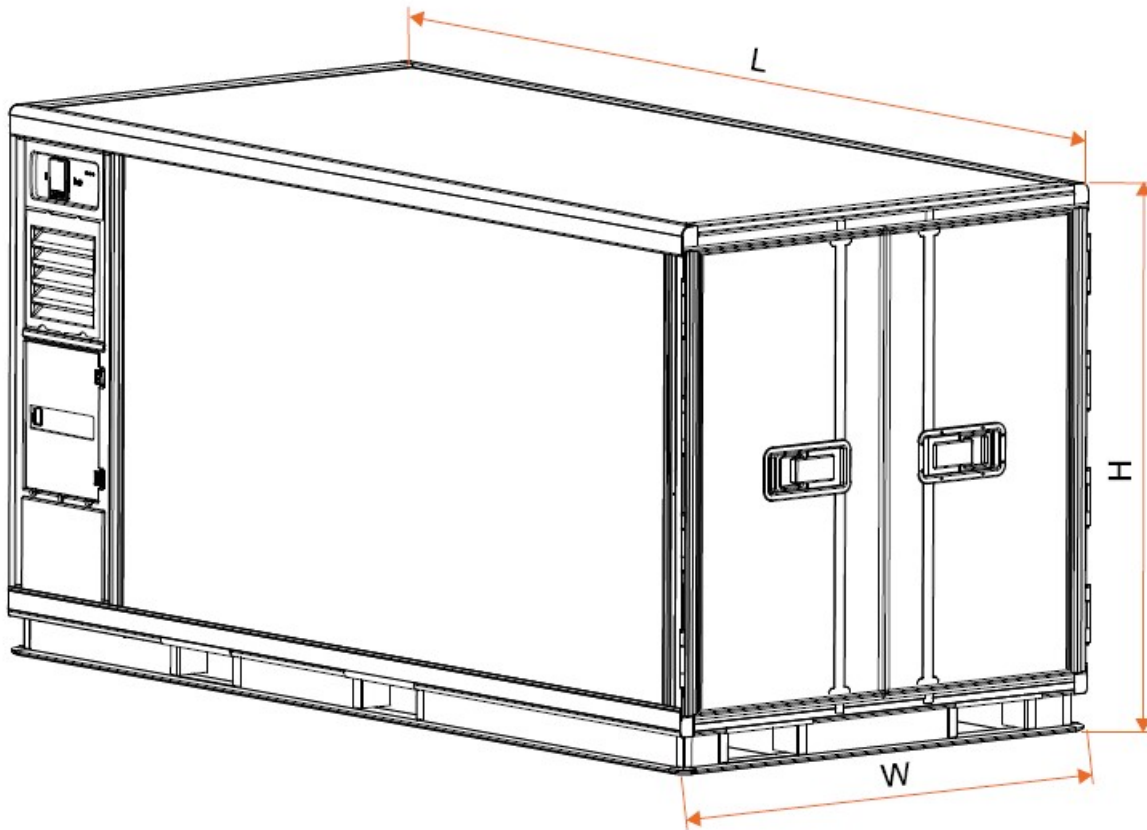

IATA CODE	RLP
DCS ITA CODE	RLP
DIMENSIONS	60,39" x 125,0" x 64,02" / 153,4 x 317,5 x 162,6 cm
MAX STRUCTURAL LOAD	6999 lb - 3175 kg
TARE	1940 lb - 880 kg
ALLOWABLE NET WEIGHT	5060 lb - 2295 kg
MAX SURFACE LOAD	- kg/m ²
VOLUME	4,4 m ³
LOADABLE ON:	A330 - A350

 Volume II HLM	ULD	6.2	Page 1
	MANAGEMENT	Ed 2/20 apr 2022	

6.2 MANAGEMENT

6.2.1 PREAMBLE

ITA made a contract with Jettainer for the leasing and management of ULDs.

Jettainer operates with an IT system named **JETTWARE** (<http://ums.jettainer.com>).

The login, is permitted only to the authorized operators; the system password can be obtained from JETTWARE (*Login*).

The Jettainer Control Centre is active from Monday to Friday 8.00 to 16.00 (Italian time) and can be contacted as follows:

- mail AZ@jettainer.com,
- telephone +39 320 5656764.

6.2.2 ALLOTMENT

The allotment for each station has been divided between passenger and cargo area. These allotments may include both containers and pallets.

According to ULD type used, the allotment for each station is agreed between Jettainer and ITA, taking into consideration the following parameters:

- scheduled flights (Winter/Summer season),
- charter flights,
- any schedule changes.

The parameters of any allotment are defined as follows:

- Minimum (**MIN**) – minimum required number of ULDs according to the operative needs.
- Standard (**STA**) – optimal number of ULDs according to the operative needs.
- Maximum (**MAX**) – maximum number of ULDs beyond each supplementary unit becomes overstock.

6.2.3 OPERATIVE MANAGEMENT

6.2.3.1 General rules

Jettainer has the responsibility to coordinate the allotment on each station, by giving operative instruction via e-mail, and verify that the stock of ULDs present at each station is as close as possible to the STA value.

Whenever the station (passenger and/or cargo sides) is unable to satisfy the operative instruction received by Jettainer or the allotment of the station decrease close to MIN value assigned, the station is responsible to contact Jettainer via e-mail in order to receive new instructions.

If previously required by Jettainer and within operational possibilities, the station shall return empty ULD of other carrier according to the instruction received.

Whenever a flight must be operated outside the network, the Outstations Coordination Department has the responsibility to coordinate with Jettainer the delivery of an adequate allotment of ULDs to the station of destination.

 Volume II HLM	ULD	6.2	Page 2
	MANAGEMENT	Ed 2 Rev 5/02 nov 23	

In FCO, LIN and in all stations that do not have in their own ULD allotment AKH containers and/or PKC pallets, Passenger and Cargo GHAs, are responsible for their ULDs assigned storage, each for its own area of expertise.

In all stations that have in their own ULD allotment AKH containers and/or PKC pallets, excluding FCO and LIN stations:

- Passenger GHA is in charge to take care of storage for all containers type. Pallets, once unloaded of their content, have to be sent to Cargo GHA.
If a Cargo GHA is not on the station, Passenger GHA is also responsible for PKC pallets storage.
- Cargo GHA is in charge to take care of storage for all pallets type. Containers, once unloaded of their content, have to be sent to Passenger GHA.
If a Passenger GHA is not on the station, Cargo GHA is also responsible for AKH containers storage.

6.2.3.2 PKC pallets request

- Passenger GHA, **up to 48 hours from flight STD**, shall ask the needed PKC pallet via e-mail to Cargo GHA of its station, putting in copy Jettainer (AZ@jettainer.com). Cargo GHA will answer keeping in copy Jettainer.
If Cargo GHA would not be able to deliver the ULD, Passenger GHA will forward once more the request to Jettainer inserting as e-mail subject: "URGENT ULD REQUEST".
- In case of pallets need **within 48 hours from flight STD**, Passenger GHA will manage accordingly with Cargo GHA locally.

ATTENTION
Pallet movement is allowed only with the net

6.2.3.3 AKH containers request

- Cargo GHA, **up to 48 hours from flight STD**, shall ask the needed AKH container via e-mail to Passenger GHA of its station, putting in copy Jettainer (AZ@jettainer.com). Passenger GHA will answer keeping in copy Jettainer.
If Passenger GHA would not be able to deliver the ULD, Cargo GHA will forward once more the request to Jettainer inserting as e-mail subject: "URGENT ULD REQUEST".
- In case of pallets need **within 48 hours from flight STD**, Cargo GHA will manage accordingly with Passenger GHA locally.

 Volume II HLM	ULD	6.2	Page 3
	MANAGEMENT	Ed 2/20 apr 2022	

6.2.3.4 Weekly inventory

On Wednesday, Passenger and Cargo GHAs shall fill in the weekly inventory on JETTWARE system (*Stock Take*) each for its own area of expertise, selecting the appropriate *Location* for Cargo ULD (C) and Baggage ULD (B).

If JETTWARE cannot be used, the SCM (ULD Stock Check Message) message in IATA standard format (AHM 423) must be sent in manual mode, addressing **HDQAOXH** (JETTWARE).

6.2.4 ULD Damages

It is allowed to load bags, cargo and mail on ULDs which have allowable damage ().

ULDs which have deformed base (not latch able), saggy structure and/or side panels (or roof) inflecting outward, shall not be loaded at any time. In such case the station must contact Jettainer to receive instructions.









ULDs (containers/pallet) which have damages greater than allowable damages must be:

- immediately individually identified by the application of a tag reporting the wording, "Unserviceable" or "U" code and that must not be removed from the ULD until the same is not repaired. For containers, the tag must be inserted in the pouch.
- positioned in a dedicated area different from the one used for serviceable ULDs.
- dispatched empty to FCO or MXP (where it is possible to arrange for their repair) with the first available flight. The departure station shall notify the loading of damaged ULDs on the field Supplementary Information (SI) of CPM (Container Pallet Message).

Unserviceable pallet nets must be dispatched only to FCO.





ULD shall not be used if any of the conditions listed in below tables are found:

NON-ALLOWABLE DAMAGES
--- PALLET ---

					
<p>The deformation of the pallet is too big for secure locking in the airplane</p>	<p>Any hole, except by design (i.e. drainage holes) occur.</p>	<p>More than one crack per 1 m² (1550 sq. in.) or one tear longer than 4" (10 cm) and 0.5" (1.25 cm) wide per 1 m² (1550 sq. in.) or one hole (up to 3.5cm²)</p>	<p>Corner connections are missing, bent or broken</p>		
<p>In case of combination of above mentioned damages reduce the values indicated by 50%</p>					
					
<p>The deformation of the side rail is too big for secure locking in the airplane</p>	<p>More than 3 broken pieces per 2 m (80") side rail length, or one broken piece over 25 mm (1") (For PKC: 2 broken pieces per 40")</p>	<p>Any broken piece in the area of aircraft locks</p>	<p>Less than 3 pairs of lips are undamaged next to lashing point and more than 10% of all net tie-down points</p>	<p>More than two missing or damaged rivets in a row or more than 5 times per 2 m (80") side rail length except the two corner rivets</p>	
<p>In case of combination of above mentioned damages reduce the values indicated by 50%</p>					

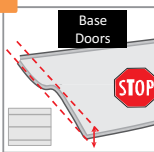
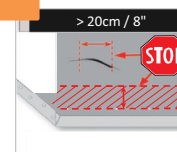
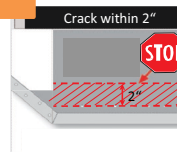
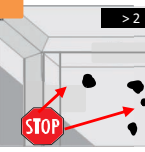
 Volume II HLM	ULD	6.2	Page 5
	MANAGEMENT	Ed 2/20 apr 2022	

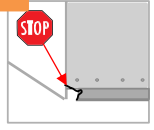
ALLOWABLE DAMAGES
--- ALUMINIUM CONTAINER ---

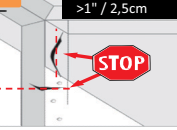
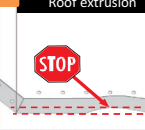
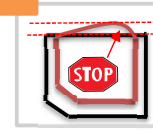
 <p>Base Doors</p> <p>Refer to damage limitation card for base and doors (page 2).</p>	 <p>>20cm / 8"</p> <p>Hole or crack is longer than 20 cm (8") vertically and 20 cm (8") horizontally or longer than 13 cm (5") on the roof</p>	 <p>Crack within 2"</p> <p>Distance between damage and rivet line is less than 5 cm (2") or a distance between two damages is less than 30 cm (12") on the shell panel or on the roof</p>	 <p>> 2</p> <p>More than 2 holes or cracks on the panels or on the roof occur</p>	 <p>>1</p> <p>More than one broken, loose or missing fasteners exist</p>	
 <p>Corner Gussets are broken, cracked, bent or loose</p>	 <p>Not readable</p> <p>TSO plate is unreadable or missing</p>	 <p>>1" / 2,5cm</p> <p>A hole is more than 2 cm (0.8") dia. Or crack more than 2,5 cm (1") in any direction (AKH and AAP: 1,5 cm (0,6")). Or indentation of whole length is more than 5 mm (0.2")</p>	 <p>Roof extrusion</p> <p>Deformation is bigger than 1 cm (0.4") or one hole is bigger than 1 cm or one tear is bigger than 4 cm (1.6") (AKH: no cracks or holes)</p>	 <p>A deflection of the panel / extrusion beyond the max. standard IATA contour exists</p>	

doors

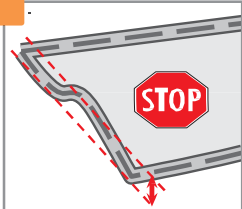
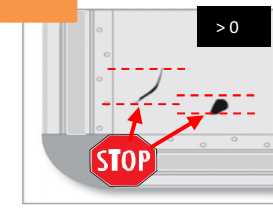
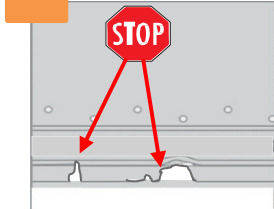
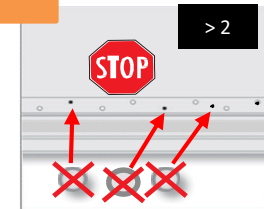
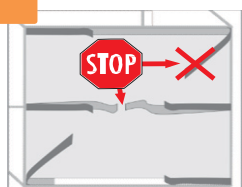
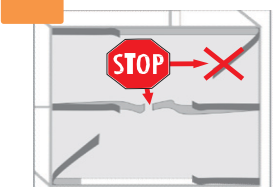
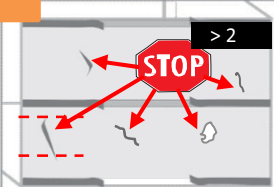
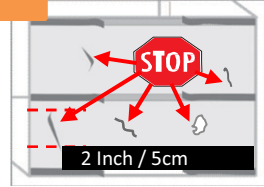
 <p>The deformation of the pallet / extrusion is too big for secure locking in the airplane</p>	 <p>Any hole or crack (except by design, drainage holes) occur</p>	 <p>Any hole/crack/ broken piece in the area of aircraft locks. Or a hole is bigger than 20 mm (0.8") or a longitudinal crack longer than 25 mm (1"). Or the damages are less than 500mm apart.</p>	 <p>More than 2 rivets per edge extrusion are missing / damaged (min distance is 300mm (12")).</p>
 <p>Webbings / velcro / tension buckles are worn-out / damaged or stitchings are missing / damaged or pull straps are missing / damaged / worn-out</p>	 <p>Hardware / cross-cables / zippers / fittings / hinges or locks are broken, loose or missing.</p>	 <p>More than 2 holes/cuts. Or distance between damages less than 500 mm (19"). Distance to edge of curtain and any hardware min. 100mm (4").</p>	 <p>Any hole or cut which is bigger than 50 mm (2")</p>

ALLOWABLE DAMAGES

--- COMPOSITE MATERIAL CONTAINER ("Light Weight" AKE) ---

<p>Refer to damage limitation card for base and doors (page 2).</p>	<p>Hole or crack is longer than 20 cm (8") vertically and 20 cm (8") horizontally or longer than 13 cm (5") on the roof</p>	<p>Distance between damage and rivet line is less than 5 cm (2") or a distance between two damages is less than 30 cm (12") on the shell panel or on the roof</p>	<p>More than 2 holes or cracks on the panels or on the roof occur</p>	<p>More than one broken, loose or missing fasteners exist</p>	
<p>Corner Gussets are broken, cracked, bent or loose</p>	<p>TSO plate is unreadable or missing</p>	<p>A hole is more than 2 cm (0.8") dia. Or crack more than 2,5cm (1") in any direction. Or indentation of whole length is more than 0.5 mm (0.2")</p>	<p>Deformation is bigger than 1 cm (0.4") or one hole is bigger than 1 cm or one tear is bigger than 4 cm (1.6")</p>	<p>A deflection of the panel / extrusion beyond the max. standard IATA contour exists</p>	







<p>The deformation of the pallet / extrusion is too big for secure locking in the airplane</p>	<p>Any hole or crack (except by design, drainage holes) occur</p>	<p>Any hole/crack/ broken piece in the area of aircraft locks. Or a hole is bigger than 20 mm (0.8") or a longitudinal crack longer than 25 mm (1"). Or the damages are less than 500mm apart.</p>	<p>More than 2 rivets per edge extrusion are missing / damaged (min distance is 300mm (12")).</p>	<p>Corner connections are missing, broken or deformed</p>	
<p>Webbings / velcro / tension buckles are worn-out / damaged or stitchings are missing / damaged or pull straps are missing / damaged / worn-out</p>	<p>Hardware / cross-cables / zippers / fittings / hinges or locks are broken, loose or missing.</p>	<p>More than 2 holes/cuts. Or distance between damages less than 500 mm (19"). Distance to edge of curtain and any hardware min. 100mm (4").</p>	<p>Any hole or cut which is bigger than 50 mm (2")</p>		

 Volume II HLM	ULD	6.2	Page 8
	MANAGEMENT	Ed 2/20 apr 2022	

ALLOWABLE DAMAGES			
--- TEMPERATURE CONTROLLED CONTAINERS ---			
Location	component	code	ULD may not be used if any of the conditions below are exceeded
base	Sheet base	SB	No cracks or holes larger than 25mm (1")
			No more than 2 holes larger than 12mm (0,5") minimum 300mm (12") apart
	Extrusion Edge Rail	EB	No cracks or holes larger than 25mm (1") minimum 500mm (20") apart
			No more than 12mm (0,5") sized bent, warped or deflected extrusion on any edge rail
	Extrusion Bracket	EB	No cracks or holes larger than 75mm (3"), minimum 300mm (12") apart on brackets between upper and lower base (forklift openings excluded)
Corner Fastner	CB FB	No cracked or missing insert corners No more than 3 missing fasteners per side, minimum 300mm (12") apart	
Doors	Lock and bracket	LD	No missing or damaged lock or bracket, door must be properly closed
Panels incl. Door panels	Sheet panel	SP	No holes larger than 200x150mm (8"x6")
			No more than 3 holes per panel and container, minimum 500mm (20") apart
			No holes are allowed in roof panel
	Extrusion (incl. Hinge)	EP	No cracks or holes larger than 25mm (1") no more than 1 per extrusion
Corner strengthener	CP	No cracks or holes larger than 50mm (2")	
	Fastener	FP	No more than 4 missing fasteners per panel, minimum 300mm (12") apart
Marking	ETSO/TSO	TM	In place and not covered, text shall be legible
Special requirements	Active ULD	AU	Lids, covers, grids and display specially designed for the active cooling system, as well as bumpers, straps, etc. are not required for airworthiness. They may be damaged/missing but shall not extend outside the allowable contour.

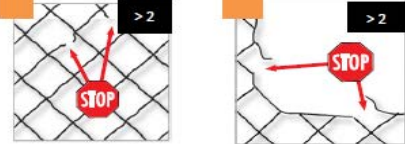
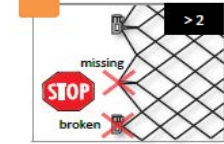
6.2.4.0.1 Unserviceable nets

Nets are unserviceable if:

<p>General</p>  <p>The expiration date is exceeded.</p>	<p>General</p>  <p>The net has been used 3 years after manufacturing date</p>	<p>Severed Cords</p>  <p>More than 2 partially or completely severed cords . Or 2 severed cords located next to each other. Or more than slight abrasion</p>		<p>Double studs (locks)</p>  <p>More than 2 locks are broken or missing. Or 2 broken / missing locks located next to each other.</p>
<p>General</p>  <p>A combination of damages exists, that reduce the max. allowed Gross weight.</p>	<p>Lashing lines</p>  <p>The lashing line is missing or shorter than 3.7 m (12 feet)</p>	<p>Tensioner Hooks</p>  <p>Hooks missing or damaged and it is not possible to effectively remove slacks with remaining hooks.</p>	<p>Identification plates</p>  <p>Both placards are unreadable or missing. (Minimum of one must be readable!)</p>	

 Volume II HLM	ULD	6.2	Page 10
	MANAGEMENT	Ed 2 Rev 5/02 nov 23	

6.2.4.1 Reception / Transfer

If for operative reasons, it becomes necessary to load ULDs of other carriers or vice-versa, Jettainer must be informed prior to that.

The reception/transfer of ULDs to/from others carriers, shall not take place unless the Unit Control Receipt (UCR) has been printed and filled in using JETTWARE (*LUC Movement*).

For the transfer of an ULD, if required from the other carrier, may be also necessary to fill in and sign the carrier's receipt.

In the Unit Control Receipt the following information shall not be omitted:

- identification code of ULD,
- description of previous damage (if present).
- description of the condition of ULD, if serviceable (SER) or damaged (DAM).
- signature of authorized personnel of the carriers of deliver/transfer of ULD.

One signed copy of the receipt must be filed in the station of transfer of the ULD.

Jettainer is responsible to supervise the entire process until the ULDs has been returned to the carrier of origin.

- **OWNER CARRIER** - Is the owner or hirer of a ULD.
- **RECEIVING CARRIER** - Is the carrier who receives a ULD from a transferring carrier at a point of transfer.
- **TRANSFERRING CARRIER** - Is the carrier who transfer a ULD to a receiving carrier at a point of transfer.

6.2.4.2 Maintenance

Maintenance of ULDs is carried out in FCO, LIN stations.

These stations are responsible to:

- inform on Wednesdays Jettainer, together with the weekly inventory about the number of unserviceable ULDs using JETTWARE (*Non-Flight Movement*),
- manage the repair process with the contracted maintenance company.
- check that the ULDs have been properly repaired by the contracted maintenance company.
- print and fill the ULD Control Receipt (UCR) using JETTWARE (*LUC Movement*) for every ULDs movement between the station and the contracted maintenance company. The UCR must be signed by the contracted maintenance company and the station designed person.

Maintenance of pallet permanent fixed nets (i.e. replacement, repair) is carried out only in FCO station.

 ITA AIRWAYS Volume II HLM	UNIT LOAD DEVICE	6.3	Page 1
	HANDLING	Ed 2/20 apr 2022	

6.3 HANDLING

6.3.1 STORAGE

Adequate storage facilities shall be provided in order to minimize or eliminate the possibility of damage or loss.

Within the storage area the following instructions must be observed:

- remove from ULDs every item (i.e.g. ropes, belts, planks, etc.) or any FOD.
- place containers in tidy rows so that you can inspect them and with their ID CODE always visible,
- do not stack containers on top of one another without using wooden spacers,
- close and secure container doors (protection against strong winds) or otherwise ensure that they will be locked with devices to prevent movement,
- Do not store containers on the ground but on a suitable base support system (i.e. dolly or container storage rack),
- stack maximum 40 pallets,
- store pallet nets in a dry place.

6.3.1.1 Unserviceable ULDs storage

Damaged ULDs unserviceable (see 6.2.4 ULD Damages) must be stored separated from the intact ones in a well recognizable and identified area by all the operators (even within the same storage area). ULDs must be individually marked by a specific tag (see 6.2.4 ULD Damages) which indicates to Ground Staff the damage.

6.3.2 MOVEMENT

When ULDs are handled please observe the following:

- close and secure container doors except for loading/unloading (protection against strong winds),



- ensure restraint stops, locks or other safety devices have been correctly applied before transporting ULDs on dollies,

 Volume II HLM	UNIT LOAD DEVICE	6.3	Page 2
	HANDLING	Ed 2 Rev 3/26 may 23	

- load ULDs longitudinal in driving direction on dollies (never lateral),



- it is forbidden to uplift ULDs with a forklift, it is allowed to position manually empty ULDs on the forks



- do not drop ULDs unassisted to the ground from dollies, storage racks or loaders,
- do not place a load on the roof of a container,
- do not forklift containers under the roof,



 Volume II HLM	UNIT LOAD DEVICE	6.3	Page 3
	HANDLING	Ed 2/20 apr 2022	

- do not damage the container (curtain, roof, panels) when using a forklift,



- do not use forklift for transportation of loaded pallets,
- do not stand pallets on their edges,
- store nets in a dry place,
- do not cut nets,
- protect the net against sharp cargo.

AIRCRAFT GROUND MOVEMENT

 ITA AIRWAYS Volume II HLM	AIRCRAFT GROUND MOVEMENT	7.1	Page 1
	GENERAL INFORMATION	Ed 2/20 apr 2022	

7.1 GENERAL INFORMATION

7.1.1 SCOPE

This section provides instructions regarding the operational and safety procedures specific to aircraft ground movement operations, identifies the roles and responsibilities associated to each role (according to local conditions and regulations).

7.1.2 GROUND STAFF RESPONSIBILITIES AND ROLES

The responsible Ground Staff shall ensure, for each aircraft arrival and departure, to assign responsibility to a person for the safe performance of the ground movement operation, and such responsibility includes:

- personnel involved in the operation are briefed of their individual responsibilities
- only persons required to perform operating functions are in the operating area
- personnel involved in the operation are positioned well clear from hazard zones
- personnel involved in the operation understand and are in agreement with how communication will be performed and how the aircraft will be manoeuvred.

In aircraft ground movement the following roles, for which Ground Staff must be properly trained, are identified as:

- **Headset Operator:** responsible for the ground movement of the aircraft, pre-departure checks and communications with:
 - Flight Deck (or Brake Operator) using an interphone system,
 - Tractor Driver (also using conventional signals, always maintaining eye contact during the manoeuvre).



Attention:

The Headset Operator shall perform the aircraft exit manoeuvre from the ERA (pushback/towing) by walking out of the tractor, positioning himself at a safe distance from the Nose Landing Gear and the tractor itself.

- **Tractor Driver:** responsible for manoeuvring the aircraft using a tug and Towbar / Towbarless towing vehicle.
- **Marshaller:** responsible for hand signal communications between Ground Staff and Flight Deck or Tractor driver, including the signalling of the aircraft final stop at the expected stopping point.
- **Brake Operator:** responsible for all Flight Deck handling activities related to the towing of an aircraft.
- **Wing Walker:** responsible for ensuring the aircraft path is clear and that aircraft extremities are clear of obstacles. Furthermore he shall:
 - be positioned so as to provide direction to the marshaller and/or tug driver to ensure that the aircraft does not come into contact with any person or object during the pushback/pull forward manoeuvre,
 - be on foot when performing wing walker duties,
 - maintain visual contact with the marshaller or driver,
 - not enter the aircraft danger zones while the aircraft is in motion,
 - carry out a stop signal to the driver or marshaller if any danger is noticed,
 - not be connected to the interphone while the aircraft is moving.

 ITA AIRWAYS Volume II HLM	AIRCRAFT GROUND MOVEMENT	7.1	Page 2
	GENERAL INFORMATION	Ed 2 Rev 12/28 feb 25	

7.1.3 MOVEMENT DEFINITIONS

- **Taxi-in:** it is defined as the moving of an aircraft from taxi position to parking position by using Aircraft engines, until the complete stop.
- **Taxi-out:** it is defined as the moving of an aircraft from parking position to the taxi position by using aircraft engines.
- **Pushback:** it is defined as the moving of a loaded aircraft from parking position to the taxi position, using a conventional Towbar system / towbarless tractor.
- **Towing:** it is defined as the moving of an aircraft to a maintenance area or another parking stand. Normally the aircraft is unloaded (no passengers or cargo).
- **Powerback:** it is defined as the moving in backwards of an aircraft from parking position to the taxi position by using aircraft engines (reverse mode).

The Company does not perform Powerback operations.

7.1.4 GSE DEFINITIONS AND UTILIZE

GSE utilized for aircraft ground movement shall be suitable for the specific operation to be conducted and shall take into account:

- type and weight of the aircraft
- weather conditions
- surface conditions.

In aircraft ground movement the following GSE are utilized:

- **Towbar Tractor (TT):** is the conventional tractor used in combination with specific towbar and shearpin connected to Nose Landing Gear (**NLG**) (for pushback and towing).
- **Towbarless Tractor (TBL):** is the vehicle equipped with an aircraft lifting system connected to NLG (for pushback and towing).
- **Main Gear controlled Tractor (MGT):** is the vehicle equipped with a system connected to Main Landing Gear (**MLG**) (for pushback only).

The Company does not perform/accept Main Gear controlled Tractor (MGT) operations.

7.1.5 WALK-AROUND CHECK

These are the controls on the aircraft carried out by the designated Ground function (independently of the ones carried out by the Maintenance Technician and/or Pilots) for each movement in and out of the parking area. For controls to be carried out during towing operations, refer to chapter 7.3.8 TOWING.

During the Walk-Around Check the aircraft conditions described in paragraph 7.1.5.1 Walk-Around Check Items shall be verified and the Walk-Around Check Form shall be completed (see paragraph 7.1.5.2 Walk-Around Check Form). Report any anomalies in the 'Notes/observations' field.

It is allowed to use different formats from the ITA one as long as the elements listed are aligned.

 Volume II HLM	AIRCRAFT GROUND MOVEMENT	7.1	Page 3
	GENERAL INFORMATION	Ed 2 Rev 12/28 feb 25	

7.1.5.1 Walk-Around Check Items

WALK-AROUND CHECK ITEMS	
Aircraft servicing panels and/or hatches (except external power and headset panels for the departure manoeuvre)	Closed & Latched
Pneumatic power access door panel	
Air conditioning ground connection access panel	
Water servicing panel(s)	
Cargo door control panel(s)	
Toilette servicing panel(s)	
Fuel servicing panel(s)	
External power panel	
Headset panel	
Cabin/Cargo doors	Closed / Locked / Checked
Door handles flush with the fuselage	
No damage to cabin/cargo doors and surrounding area	
No obvious damages to fuselage and engine cowlings	Checked
The pitot static tubes, static ports and angle of attack sensor, parking brake light warning operation	
The wings visible surface included wing tips	
The engine cowling visible surface	
The empennage and horizontal stabilizer visible surface	
The visible skin panels	
Excessive fluid leakage	Checked
Engines	
Nose and landing gear structures	
Servicing panels	

 ITA AIRWAYS Volume II HLM	AIRCRAFT GROUND MOVEMENT	7.1	Page 4
	GENERAL INFORMATION	Ed 2/20 apr 2022	

7.1.5.2 Walk-Around Check Form

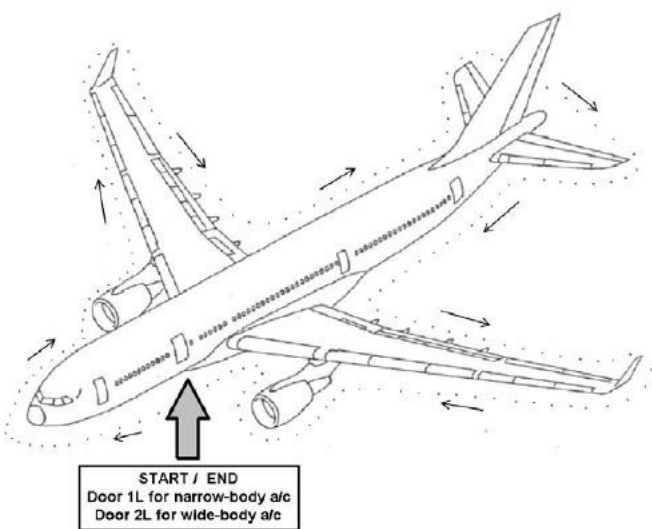
 WALK-AROUND CHECK FORM						
Arrival <i>(Ref. GOM / HLM - 7.2)</i>	<input type="checkbox"/>	Departure <i>(Ref. GOM / HLM - 7.3)</i>	<input type="checkbox"/>	A/C Type:	A/C Reg.:	
Flight number:	<input type="checkbox"/>	Flight number:	<input type="checkbox"/>	Date:		
			Check the following items:			
			Cabin Doors	<input type="checkbox"/>	Cargo Doors	<input type="checkbox"/>
			Fuselage	<input type="checkbox"/>	Engine Cowlings	<input type="checkbox"/>
			Excessive fluid leakage	<input type="checkbox"/>		
Notes/observations:						
Block time (LT): h ____ : ____		Discovered at (LT): h ____ : ____		Company advised at (LT): h ____ : ____		
GSR Filled in (if applicable)		<input type="checkbox"/>	ARRIVAL Signature:		DEPARTURE Signature:	

Walk-around shall be performed :

- By Ground Staff designated as responsible for the walk-around independent from any exterior check performed by maintenance technician and/or pilot.
- After engine shut-down and before GSE has been positioned. It is allowed to position disembarkation devices and GSE, even during the inspection, after being checking that there are no damages on the affected areas.
- After GSE has been removed and before aircraft exit maneuver from parking area.
- At walking speed.

 ITA AIRWAYS Volume II HLM	AIRCRAFT GROUND MOVEMENT	7.2	Page 1
	AIRCRAFT ARRIVAL	Ed 2/20 apr 2022	

7.2 AIRCRAFT ARRIVAL

7.2.1 ACTIONS PRIOR TO AIRCRAFT ARRIVAL

The responsible Ground Staff have to:

- conduct foreign object damages (FOD) check on entire stand removing all debris just prior to arrival.
- make sure the stand surface condition is sufficiently free of ice, snow, etc., to ensure a safe aircraft movement.
- make sure all needed Ground Support Equipment (GSE) is available, serviceable and positioned well clear of the aircraft path, outside the ERA with parking brakes on.
- make sure all loading bridges are fully retracted and positioned in the dedicated area (if applicable).
- make sure the aircraft path and ramp area are free of objects, which the aircraft may strike endanger others due to jet blast effects.
- make sure that the following equipment is serviceable and available at arrival stand:
 - chocks and safety cones (as required by aircraft type)
 - ground power 400 Hz (as required by aircraft type), in order to reduce the use of the aircraft's Auxiliary Power Unit (APU) and to expedite engine shut-down. The ground power should be connected directly after the aircraft has come to a complete stop on its final parking position.
 - preconditioned air (if applicable)
 - headset (if headset communication is applicable as per aircraft type).
 - parking guidance system (if applicable) or marshalling personnel is present.
- make sure additional ground personnel (such as wing walkers) are present (if required).

 Volume II HLM	AIRCRAFT GROUND MOVEMENT	7.2	Page 2
	AIRCRAFT ARRIVAL	Ed 2 Rev 12/28 feb 25	

7.2.2 ARRIVAL PROCEDURE



Caution:

Ground Staff and concerned equipment (i.e. GPU), except particular needs, must approach the aircraft frontally referring to the longitudinal axe of the same aircraft. Pay particular attention in keeping the position outside the engine on intake danger area (see Cap. 5.X.X INFORMATION FOR TYPE OF AIRCRAFT).

The following procedure describe the required assistance sequence at aircraft arrival:

Upon aircraft stopping and engine still running (as per Company guidelines and local regulations):

1. Wait until the aircraft has stopped on the correspondent stop signal on the stand.



Caution:

In case the anti-collision lights are off (beacon lights), while crew may not be aware of it, ground staff shall establish visual contact with cockpit and ask confirmation about engine spool-down. When possible connect inter-phone and report failure to Captain.

2. Position wheel chocks at the nose landing gear wheels.
3. Establish a communication with the Flight Deck via interphone.

Note: In the event that the interphone or headset is not available or unusable (i.e. thunderstorm activity), the back-up method “marshalling hand signals” (see Chap. 7.4 HAND SIGNALS) shall be used for arrival operations.

4. Ask confirmation to Flight Deck that parking brake is engaged.



Caution:

Inform the Flight Deck if the parking brake warning light malfunctions. Notification to the Captain shall be recorded on the Walk-Around Check Form.

The parking brake is engaged:

- for A320F, A330, A350 aircraft if the amber light is on;
- for A220 aircraft if the green light is off.

5. Connect the Ground Power Unit.

After engine has been shut down and anti-collision lights have been switched off:

6. Position wheel chocks at the main landing gear wheels and confirm to Flight Deck.
7. Before positioning boarding devices, inspect cabin door and surrounding area for existing damage.
8. Position the marker cones as per aircraft type.
9. Inspect the items detailed in chapter 7.1.5 WALK-AROUND CHECK prior to give clearance to position GSE at aircraft.

 Volume II HLM	AIRCRAFT GROUND MOVEMENT	7.2	Page 3
	AIRCRAFT ARRIVAL	Ed 2 Rev 12/28 feb 25	

If the Ground person concerned, designated as responsible for performing checks in accordance with WALK-AROUND CHECK FORM, detect any damage, he shall notify it within 15 minutes from the ATA (Actual Time of Arrival) to a Company Representative and to flight crew

10. Position GSE, even during the inspection, after being checking that there are no damages on the affected areas. Do not position GSE where damage is detected



Caution:

Do not wear a headset connected to the aircraft during a thunderstorm or if a weather alert has been issued.

Note:

Some passenger boarding bridges are equipped with an external power cable whose connection inhibits the bridge movement. In this case, the bridge may be moved toward the aircraft if the engine no. 1 (on the bridge side) has been shut down. Otherwise wait until engines have shut down and APU has been turned on (if APU is inoperative connect external GPU) before moving the bridge.

7.2.3 AIRCRAFT ARRIVAL AT THE STAND WITH HOT BRAKES (SMOKING OR ON FIRE)

Note:

Smoke coming out of the brake assemblies is typical in high humidity air conditions, regardless of the brake temperature being well inside the normal operating range.

If smoke is detected, the following precautionary measures shall be applied:

1. Inform the Captain via interphone and wait for response:
 - A. If the brake temperature is within limits, proceed with standard procedures.
 - B. If the brake temperature is outside limits:
 - a. chock the NLG and the MLG on the opposite side (if applicable).
 - b. call maintenance personnel for inspection on Flight Crew's request.



Caution:

Stay clear of smoking brakes! The aircraft wheels may explode.

 Volume II HLM	AIRCRAFT GROUND MOVEMENT	7.2	Page 4
	AIRCRAFT ARRIVAL	Ed 2 Rev 12/28 feb 25	

2. If fire is detected:
 - a. Inform the Captain via interphone (or by marshalling signals).
 - b. Chock the NLG and wait for instructions.
 - c. Approach the aircraft with boarding devices (stairs or loading bridge) only with Captain's approval. Other GSE shall not be positioned until the fire has been extinguished and Maintenance personnel has given the authorization to offload the aircraft.



Caution:
 Do not use the fire extinguishers available on the apron. The Fire Brigade will take action.

 ITA AIRWAYS Volume II HLM	AIRCRAFT GROUND MOVEMENT	7.3	Page 1
	AIRCRAFT DEPARTURE	Ed 2 Rev 8/15 mar 24	

7.3 AIRCRAFT DEPARTURE

7.3.1 PUSHBACK OPERATION REQUIREMENTS

Prior to the aircraft movement, the responsible Ground Staff must ascertain that the following requirements are met:

ACTION	PUSHBACK	
	T	TBL
Fire protection devices are available and correctly positioned (as per local rules)	x	x
The ramp surface condition is adequate for movement operations (snow, ice, etc.) and clear of items that might cause aircraft foreign object damage (FOD)	x	x
The tractor and by-pass pin combination (if applicable) are suitable for the operation and for the aircraft type	x	x
The inter-phone communication system is serviceable for ground/flight/ground communication	x	x
If necessary to use an Air Start Unit (ASU) or a Ground Power Unit (GPU), ensure that the equipment is available	x	x
Additional Ground Staff is present if required (ie: wing walker)	x	x
The bypass pin is installed (if applicable)	x	x
Inform Flight Deck before connecting pushback to aircraft	x	x
Ask authorization to Flight Deck for NLG chocks removal. Provide equipment connection and stabilize vehicle. Pushback connection can be performed even with GSE (loader, belt loader) and loading bridge still approached to the aircraft		x
Perform the Walk Around Check (as foreseen in cap 7.1.5/8.2) before pushback operation	x	x
Inform Flight Deck: Walk Around Check performed, pushback connected, chocks removed	x	x
Receive by Flight Deck authorization to start pushback operation	x	x
Lift the aircraft only after all GSE, equipment have been removed and positioned outside the ERA and the loading bridge has been completely retracted and positioned in its bay (if applicable)		x
Before starting pushback operation, check that the whole manoeuvring area is free from personnel and obstacles	x	x
During pushback check that the manoeuvring area remain always clear and inform promptly all personnel involved in case of anomalies and emergencies	x	x
Coordinate the vehicle disconnection with all concerned	x	x
Verify the by-pass pin removal (if applicable)	x	x



Caution:

Inform the Flight Deck and/or contact the Maintenance Department (as well as the Company Representative) for a technical inspection, if:

- any type of excessive fluid leakage is observed,
- signs of unmarked aircraft damage are noticed,
- any fault, failure, malfunction or defect is observed.

 Volume II HLM	AIRCRAFT GROUND MOVEMENT	7.3	Page 2
	AIRCRAFT DEPARTURE	Ed 2 Rev 8/15 mar 24	

7.3.2 COMMUNICATION DURING DEPARTURE OPERATIONS

Communication during aircraft departure operations: self-manoeuvring, pushback, with asu/gpu and towing shall be conducted via interphone (headset).

The communication system shall be tested before starting operations.

In order to avoid misunderstanding, pushback and engine start up operation shall be performed using the standard phraseology.



Caution:

During storm activities on the airport or in case of weather alert, communication via headset is not allowed.

In the event that the interphone or headset is not available or unusable (i.e. thunderstorm activity), the back-up method “marshalling hand signals” (see Chap. 7.4 HAND SIGNALS) shall be used for departure operations.

Prior to departure a briefing must be held between the Flight Deck and the Ground Agent responsible for the departure, including:

- Review of departure specifics, i.e. direction of movement, final positioning, and taxi out direction.
- The hand signals to be used, including emergency signals.
- Specific arrangement, if applicable.

Note:

During communication terms LEFT or RIGHT are always referred to the Flight Deck point of view and not from that of the Ground Staff.

 ITA AIRWAYS Volume II HLM	AIRCRAFT GROUND MOVEMENT	7.3	Page 3
	AIRCRAFT DEPARTURE	Ed 2 Rev 8/15 mar 24	

7.3.2.1 Restoring interphone communication at the end of operation

The below procedure must be followed in case Ground Staff or Flight Deck need to re-establish interphone communication after disconnection.

A. In case of Ground Staff

Ground Staff performs the marshalling manual signal for stop (emergency stop see cap 7.4). Flight Deck engages parking brakes and confirms received by flashing le taxi-lights three times

B. In case of Flight Deck

Flight Deck engages parking brakes and indicates that interphone connection is needed flashing taxi-lights three times. Ground Staff confirms request received by marshalling manual signal for stop (emergency stop see cap 7.4).

In both cases respect the following rules:

- Only the person establishing the interphone communication will be allowed to approach the aircraft after ensuring that Flight Deck noticed it and realized its intention.
- Approaching the aircraft shall be performed in the direction that allows the maximum visibility period by Flight Deck keeping safety distance from the running engines.

7.3.3 ANTI-COLLISION LIGHTS

After all doors are closed, ATC will authorize the aircraft to move or to start the engines up. At this moment Flight Deck will switch on the anti-collision lights.



.Caution:

Switching on the anti-collision lights is a visual indication to Ground Staff of imminent engine start up or aircraft movement. In case of a lower anti-collision light failure, the Flight Deck will advise the agent in charge of the departure operation.

 ITA AIRWAYS Volume II HLM	AIRCRAFT GROUND MOVEMENT	7.3	Page 4
	AIRCRAFT DEPARTURE	Ed 2 Rev 8/15 mar 24	

7.3.4 ENGINE START

Coordinate the starting engines up sequence with the Flight Deck



Caution:
 During the engine start communicate with the Flight Deck only if you observe circumstances that require immediately notification and action by the Flight Deck.

The aircraft engines are numbered for the Ground Staff facing the aircraft, from right to left.

7.3.5 TAXI-OUT DEPARTURE (SELF MANOEUVRING)

The responsible Ground Staff shall accomplish the following procedure:

- Connect headset.
- Ask confirm to Flight Deck that parking brake is set and coordinate chocks removal.
- Remove chocks from MLG and keep in position the ones on NLG.
- Ensure that the area is clear from personnel and obstacles.
- Follow instructions for engine start up.
- Once engine start up is finished, wait for Flight Deck authorization to remove NLS chocks

7.3.5.1 Standard phraseology: self-manoeuving departure communication

Following the standard communicating phraseology between Ground Staff and Flight Deck.

GROUND STAFF	FLIGHT DECK
Call: "Cockpit from Ground"	
	Answer: "Go ahead"
Call: "Confirm parking brakes are set"	
	Answer: "Parking brakes are set"
Call: "Pre-departure servicing checks completed, chock removed. Ground is ready for start engine"	
	Answer: "Start engine ..."
Answer: "Start engine ..."	
	Cockpit: "Regular start engine, you may disconnect....waiting for all clear sign"
Answer: "Disconnecting, hold for clear sign... (*) "	
(*) Clear sign position vary depending on the stand area	

 Volume II HLM	AIRCRAFT GROUND MOVEMENT	7.3	Page 5
	AIRCRAFT DEPARTURE	Ed 2 Rev 8/15 mar 24	

7.3.5.2 Engine star up by Air Start Unit (ASU) and/or Ground Power Unit (GPU)

Ground Staff may start the pressure only at request of the Flight Deck, immediately before the start up of the engine.

After completion of the engine starting assistance and disconnecting the interphone communication cable (if applicable), the responsible Ground Staff must give the "all clear" signal.

This signal may not be given before all equipment and personnel are clear of the aircraft taxi path and it is safe for the aircraft to commence taxiing.

7.3.5.2.1 Communication during engine start up by ASU and/or GPU

Engines start up operation on the stand shall be performed by two operators:

- an operator communicating with Flight Deck
- an operator dedicated to Air Start Unit.

Note

The engine start up on the stand foresees the closure of the service road behind the aircraft (if applicable) and communication with airport authorities (if applicable).

Following the standard communicating phraseology between Ground Staff and Flight Deck.

GROUND STAFF	FLIGHT DECK
Call: "Cockpit from Ground"	
	Answer: "Go ahead"
Call: "Confirm parking brakes are set"	
	Answer: "Parking brakes are set"
Call: "Pre-departure servicing checks completed, chock removed. Ground is ready for start engine"	
Call: "ASU is available"	
	Call: "Pressurize"
<i>Operator gives the supplying signal to the ASU operator</i> Answer: "Pressure available"	
	Call: "Is clear to start engine ..."
Answer: "Clear to start engine ..."	
	<i>Flight Deck turns on engine</i> Call: "Remove Air Start Unit (and Ground Power Unit)"
Answer: "Air Start Unit (and Ground Power Unit) removed"	

7.3.6 NO VISIBILITY AREA FROM COCKPIT

The following scheme represents the area (marked in red) within which Flight Deck has no visibility of what is happening under the aircraft. Therefore it is necessary to be positioned outside this area (No Visibility Area).

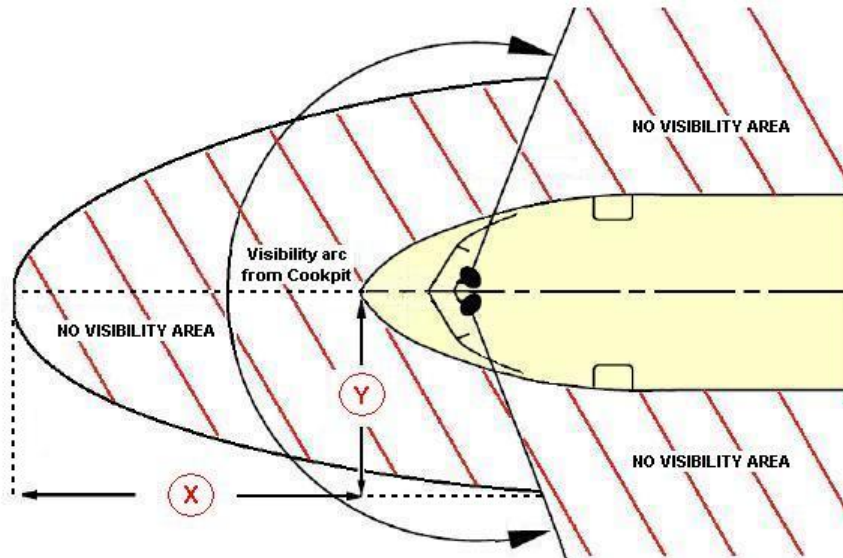

NO VISIBILITY AREA FROM COCKPIT

Aircraft type	Visibility range from Cockpit	Measure X	Measure Y
A350	225°	14.2 m	9 m
A330	230°	14 m	9 m
A321 neo /A320/ A320 neo	220°	11 m	10 m
A220	123°	10.5 m	10 m



 Volume II HLM	AIRCRAFT GROUND MOVEMENT	7.3	Page 7
	AIRCRAFT DEPARTURE	Ed 2 Rev 8/15 mar 24	

7.3.7 PUSHBACK

Only trained and qualified personnel is allowed to perform operations.

Operations are conducted by the following vehicles:

- towbarless tractor(TBL).
- towbar tractor (TT).

Manoeuvre can be executed as follows:

- two operators. A driver on the tractor and an operator responsible for departure and communication with Flight Deck
- One Man Operator

In case of TT, two operators are necessary



Attention:

In case traffic or weather conditions will be critical, the attendance of a Wing Walker is necessary in order to assist the stand entrance and the exit of the aircraft.

 Volume II HLM	AIRCRAFT GROUND MOVEMENT	7.3	Page 8
	AIRCRAFT DEPARTURE	Ed 2 Rev 12/28 feb 25	

7.3.7.1 Actions to perform before starting the manoeuvre

Before starting the manoeuvre, the pushback operator has the responsibility to check if the tractor and the by-pass pin are in compliance with the regulations and standards applicable to the operation, considering the type of aircraft, weather conditions and the apron surface.

The operator shall perform the following procedure:

- Verify vehicle functionality
- Verify compatibility between vehicle and aircraft
- Insert by-pass pin where applicable.
- Before removing chocks from NLG to connect tractor, ask confirmation via interphone (or by standard marshalling signs) that parking brake is set. Keep chocks positioned on the MLG.



Caution:

Inform the Flight Deck if the parking brake warning light malfunctions. Notification to the Captain shall be recorded on the Walk-Around Check Form.

The parking brake is disengaged:

- for A320F, A330, A350 aircraft if the amber light is off;
- for A220 aircraft if the green light is on.

- Pushback connection can be conducted even if GSE and/or loading bridge are approached to the aircraft.
- Coordinate with Flight Deck chocks removal from MLG

As an example, it is shown the A320 family steering system

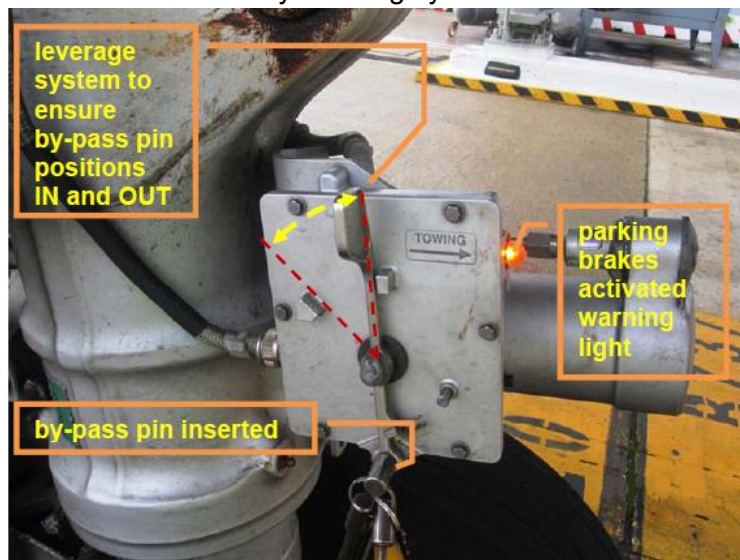

 ITA AIRWAYS Volume II HLM	AIRCRAFT GROUND MOVEMENT	7.3	Page 9
	AIRCRAFT DEPARTURE	Ed 2 Rev 12/28 feb 25	



Caution:

The bypass pin must be:

- labelled with the specific aircraft type(s) for which it can be used.
- identified with a "Remove Before Flight" streamer.
- checked regularly for proper technical condition or as per manufacture instructions

For A220 aircraft wait for Flight Deck instructions before starting pushback operations (towing green light on), it is not necessary operate on the switches located inside the external power.



Caution:

Towbar must never be overtaken.



Caution:

During operation keep maximum attention inside the Pushback Hazard Zone

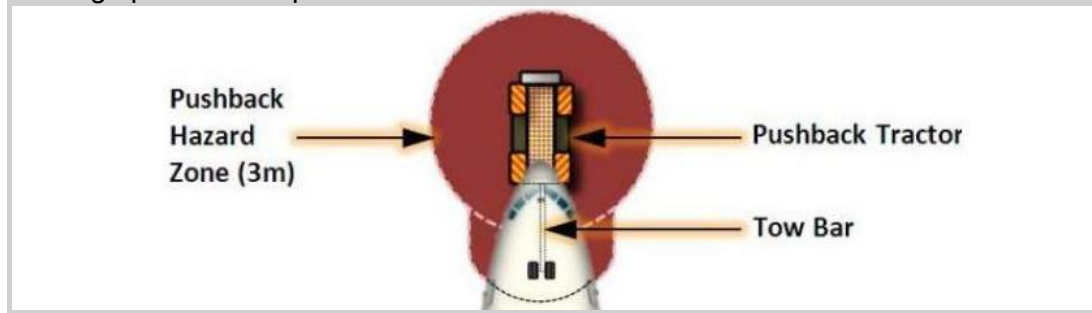

Note:

Ensure that the tractor is not left unattended with engine running (only exception is in cold weather operations with the pushback vehicle chocked).

 ITA AIRWAYS Volume II HLM	AIRCRAFT GROUND MOVEMENT	7.3	Page 10
	AIRCRAFT DEPARTURE	Ed 2 Rev 8/15 mar 24	

7.3.7.2 Manoeuvre

1. In case of TBL, lift the aircraft only once:
 - all equipment involved in handling is outside the stand bordered with the red line (ERA) and the loading bridge is fully retracted and repositioned in its dedicated area (if applicable).
 - the Flight Deck is notified and confirmation on parking brake set has been received.
2. Manoeuvre can be performed only after authorization has been given.
3. Verify that parking brake is disengaged (amber light off for A320F, A330, A350 and green light on for A220).
4. Verify that anti-collision lights are on.
5. Keep manoeuvre speed at minimum. Operate gently vehicle brakes, when stopping or slowing the aircraft movement.
6. Ensure that the oversteering limits of the nose landing gear are not exceeded.



Caution:

- When using a TBL equipped with either an over steer warning or over steer protection device, verify the visual turning limit markings at all times to prevent exceeding of the maximum nose gear steering angle.
- When using a TBL, the "over steering" or "over torque" system of the tractor must be operative.
- In the event of exceeding the maximum nose gear steering angle, inform the Flight Deck, if applicable, for a technical inspection. The aircraft must return to the parking stand in order to check if the gear is not damaged.

7. While approaching to the assigned position, the aircraft must be moved in a straight line for a few metres to ensure that the front wheel is in line with the main gear. This limits the torsional stress applied to the wheels.
8. Markings drawn on apron shall be taken as reference during the manoeuvre.
9. Ensure safety distance from aircraft.
10. Once the manoeuvre is completed, engage the tractor parking brake

 ITA AIRWAYS Volume II HLM	AIRCRAFT GROUND MOVEMENT	7.3	Page 11
	AIRCRAFT DEPARTURE	Ed 2 Rev 8/15 mar 24	

7.3.7.3 Subsequent operations to pushback and engine start up

When movement has been stopped and prior to disconnecting the TBL or TT from the aircraft Nose gear, the operator shall:

1. Inform the responsible for communication that pushback operations are finished
2. Verify that aircraft parking brake has been engaged (A320F, A330 e A350 amber light on, A220 red light on)
3. Disconnect vehicle from NLG
 - a. In case of towbarless tractor (TBL):
 - disconnect tractor with speed at minimum.
 - b. In case of towbar tractor (TT):
 - release tractor parking brakes in order to release tension from the towbar,
 - lower the towbar wheels to the ground,
 - disconnect the towbar from the nose landing gear.
4. Remove vehicle from the no visibility area and from the aircraft manoeuvring area.



 Volume II HLM	AIRCRAFT GROUND MOVEMENT	7.3	Page 12
	AIRCRAFT DEPARTURE	Ed 2 Rev 8/15 mar 24	

7.3.7.4 One Man Operator - OMO

The only vehicle that can be used for the OMO procedure is the TBL.

The activity is carried out only by the tractor driver, who shall:

- Verify the functionality of the vehicle
- Verify compatibility between vehicle and aircraft
- Perform the Walk Around Check (see cap. 7.1.5)
- Insert the by-pass pin
- Connect the tractor ad listed in 7.3.7.1
- Communicate via interphone system (headset).
- Inform Flight Deck, before starting manoeuvre, that operations will be carried out in “One Man Operator” mode.
- Conduct a briefing with personnel involved in ramp.
- Notify cockpit in case of operational changes.
- Notify Flight Deck “pushback operation finished. Engage parking brake”.
- Check that parking brake is engaged.
- Position tractor outside the “No Visibility Area”.
- Keep communication with Flight Deck.
- Engage tractor parking brakes.
- Wait for clearance from Flight Deck to deactivate the by-pass steering system.
- Coordinate with Flight Deck position for “All Clear” signal.
- Disconnect headset.
- Move the vehicle away from the aircraft manoeuvring area



Attention: in case of low visibility, due to vehicle characteristics or to weather conditions, the two operators procedure shall be applied.

7.3.7.5 Manoeuvring in severe weather and surface condition

During adverse weather conditions (fog, rain, etc.) visibility and traction can be affected. Therefore, the Tractor Driver must reduce and adapt velocity in order to take taxi conditions in account.

When manoeuvring the aircraft on slippery apron surfaces (i.e. icing condition), extreme caution is required to avoid losing control of the tow tractor due to skidding. Many elements can contribute to the hazards involved, such as strong winds or uneven surface. The following minimum precautions must be observed, if applicable:

- Avoid sudden turns, deceleration or acceleration.
- Except when using an ASU aircraft engines may only be started when:
 - a. the pavement is in such condition that reasonable traction is ensured.
 - b. the aircraft parking brakes are set and the aircraft is disconnected from the tractor.

 Volume II HLM	AIRCRAFT GROUND MOVEMENT	7.3	Page 13
	AIRCRAFT DEPARTURE	Ed 2 Rev 8/15 mar 24	

7.3.7.6 Standard phraseology: communication with pushback manoeuvre

GROUND STAFF	FLIGHT DECK
Call : "Cockpit from ground"	
	Answer: "Go ahead"
Call : "Confirm parking brakes are set"	
	Answer: "Parking brakes are set" Call: "Confirm by-pass pin installed"
Answer : "By-pass pin in talled"	
Call: "Pre-departure servicing checks completed, ground is ready for lifting, and pushback"	
	Answer: "Roger, (you may lift the aircraft) stand-by for pushback "
	<i>Pushback request.</i> <i>Clearance confirmed:</i> Call: "Ready for pushback"
Call: "Lifting completed release parking brakes"	
	<i>Parking brakes released:</i> Answer: "Parking brakes released"
Call: "Commencing pushback"	
Call: "Area clear, ready to start engine"	
	Answer: "Running engine number.."
Call: "Pushback completed. Set parking brakes. Engine ... clear. Ready to start engine ..."	
	Answer: "Parking brakes set. Starting engine ..."
	<i>Once the engine start up is completed:</i> Call: "You may disconnect"

 Volume II HLM	AIRCRAFT GROUND MOVEMENT	7.3	Page 14
	AIRCRAFT DEPARTURE	Ed 2 Rev 8/15 mar 24	

<u>Tractor is disconnected and stopped in a visible position for the al Flight Deck.</u> Answer: "Disconnecting, hold position and wait for visual signal...(*)"	
(*) Clear sign position vary depending on the stand area	
	Answer: "Holding position and standing for a visual signal...."
	<u>Clearance signal received (by "thumb up").</u>

7.3.7.7 Emergencies during engine start up

7.3.7.7.1 Communication during Engine Fire

A standard procedure for interphone communication during an engine fire cannot take into account every situation that may arise. The information hereafter must therefore be applied with common sense, taking into account the circumstances of the particular situation.

Note:

The Flight Deck informs the Control Tower of the situation.

7.3.7.7.2 Engine fire

The Flight Deck normally detects an engine or APU fire and will take action using the engine fire extinguishing system. However, alert the Flight Deck immediately if flames are noticed from the engine or engine pylon.



Caution:
Do not fight engine fires with fire extinguishers on the ground. The Flight Deck will take action.

7.3.7.7.3 Tailpipe fire

In the event that, during engine starting, flames are noticed from the engine exhaust tailpipe, the Flight Deck must be alerted immediately, as such a fire is not detectable via fire warning systems in the Aircraft.

Note:

Take into account that for a few seconds after starting an engine, smoke could be noticed from the exhaust of the engine, caused by switching on the fuel supply.

7.3.7.8 Instruction in case of pushback incidents

7.3.7.8.1 General incident

Incident	Ground Staff		Expected Flight Crew's actions
	One Man Operation	Normal Operation	
Interphone failure	Stop immediately. Contact dispatcher via radio. Wait for assistance		Wait for a second operator to complete operations
		Stop immediately. Inform the Flight Deck about the interphone failure by using marshalling signals	Gives permission to check the interphone connection using hand signals
Aircraft about to overtake tug / vehicle	Immediately request the Flight Deck to stop the aircraft using a gentle brake application	Immediately request the Flight Deck to stop the aircraft using a gentle brake application. In addition to the use of the headset communication system, other Marshalling signals can be used	Stop the aircraft using a gentle brake application
GSE / aircraft connection lost		Notify the Flight Deck immediately towbarless towing vehicle and aircraft is lost	Stop the aircraft using a gentle brake application

 ITA AIRWAYS Volume II HLM	AIRCRAFT GROUND MOVEMENT	7.3	Page 16
	AIRCRAFT DEPARTURE	Ed 2 Rev 8/15 mar 24	

7.3.8 TOWING

During towing, personnel admitted on board are limited to Maintenance Technicians and any authorized Company Staff.



Caution:

All personnel on board (both in the cockpit and in the cabin, if any) shall sit with their seatbelts fastened during towing.

The manoeuvre can be performed in the following mode:

- **Tractor Driver + Brake Operator (for A320 aircraft only)**
The Tractor Driver is responsible for aircraft manoeuvre by using a TBL only.

- **Headset Operator + Tractor Driver + Brake Operator**
The Headset Operator is responsible for aircraft manoeuvre by using a TBL or a TT.

 Volume II HLM	AIRCRAFT GROUND MOVEMENT	7.3	Page 17
	AIRCRAFT DEPARTURE	Ed 2 Rev 8/15 mar 24	

7.3.8.1 Manoeuvre

The next safety indications shall be followed during the towing operations:

- Align the tractor or the tow bar with the aircraft centre line before moving.
- Completely uplift the towbar wheels before manoeuvre (if applicable).
- Initialize pushback operation in straight line.
- Keep towing speed limit within the margins regulated by the towing equipment, aircraft and airport.
- Do not exceed the speed limit of the manoeuvre as established for the aircraft, by the airport or for the equipment.
- Follow the apron signposting as a guidance during operation in order to avoid eventual obstacles.
- Keep minimum safety distance between vehicles.
- Follow the instructions of the Follow-me.
- Stop at 50m from the taxiway intersection, if a STOP is required.
- Avoid sharp turns that could cause excessive attrition on the wheels.
- Once reached the established position, tow the aircraft in straight line for several meters, in order to ensure that nose gear wheels are in line with the aircraft axis. This will relieve the main gear wheels torsion.



Caution:

- Prior to commence any movement from/to maintenance hangar area or whenever the condition of traffic and/or whether are severe, is necessary the presence of wing walkers.
- Particular attention must be done during severe weather conditions or poor visibility. When in doubt gives "stop signal".
- When towing in adverse weather conditions (i.e. ice or snow), the Tractor Operator shall:
 - maintain a reduced towing speed, particularly before entering a turn;
 - avoid stopping movement in a turn, to the extent possible.

7.3.8.2 Towing limits

Fuel and other loads can affect an aircraft's balance. To avoid "tail tipping" during towing, ensure that the actual center of gravity of the aircraft is forward of the critical centre of gravity. If you are unable

 Volume II HLM	AIRCRAFT GROUND MOVEMENT	7.3	Page 18
	AIRCRAFT DEPARTURE	Ed 2 Rev 8/15 mar 24	

to determine this, then you must request assistance from a qualified weight and balance agent of the Company.



Danger:

In case of towing an aircraft with hydraulic problems (brakes not working), speed shall be reduced to the minimum

7.3.8.3 Starting towing - check list

ACTION	Brake Operator	Tractor Driver	Headset Operator
Fire protection devices are available and correctly positioned (as per local rules).		x	x
The ramp surface condition is adequate for movement operations (snow, ice, etc.) and clear of items that might cause aircraft foreign object damage (FOD).		x	x
The tractor and by-pass pin combination (if applicable) are suitable for the operation, considering the aircraft type and weight, the weather conditions and the ramp surface condition.		x	
The pressure of the hydraulic system for aircraft braking and/or the brake accumulator is within required pressure range.	x		
Those electrical systems, needed for towing, are energised (APU on or external power supplied by the tractor).	x		
Connect and test the interphone link.	x	x	x
The safety pins of MLG are installed and controlled.	x	x	x
Install bypass pin or check that Nose Gear steering torque link is in ON position.	x	x	x
Before connecting the tractor, ensure that the aircraft MLG is chocked.		x	x
Give permission to connect the TT or TBL after applying the aircraft parking brake.	x		
Connect the towbar; first to the aircraft then to the tractor.		x	x
Connect the tractor and set the parking brake.		x	
All persons not involved in the aircraft departure operations, GSE and other equipments are clear of the departing aircraft, outside the ERA. Loading bridge is fully retracted and repositioned in its dedicated area (if applicable).		x	x
The required Walk-Around Check (see note below) is completed as described in chap. 7.1.5 WALK-AROUND CHECK. In case of NO TRANSIT CHECK refer to chap. 8.2.		x	x
All persons involved in the aircraft movement stay well clear of the danger areas around the tractor (if applicable), landing gear and engines.		x	x
Remove or check removal of aircraft chocks. These shall be repositioned in the dedicated area.		x	x
Contact the Control Tower for clearance to start moving the aircraft (depending on local regulations).	x	x	x
After receiving the clearance release the aircraft parking brake.	x		
Switch on the external and anti-collision lights of the aircraft.	x		
Request confirmation from Brake Operator that the aircraft parking brake has been released.		x	x
Check that Wing Walker are positioned (when applicable).		x	x
Aircraft is clear of all obstacles along the intended movement path.		x	x
Start towing.		x	

 Volume II HLM	AIRCRAFT GROUND MOVEMENT	7.3	Page 19
	AIRCRAFT DEPARTURE	Ed 2 Rev 8/15 mar 24	

7.3.8.4 End of towing - check list

Before the aircraft enters ERA, the Ground Staff responsible shall verify that the conditions described in chapter 7.2.1 ACTIONS PRIOR TO AIRCRAFT ARRIVAL are met.

Otherwise, it shall indicate that the aircraft is not allowed to enter ERA.

ACTION	Brake Operator	Tractor Driver	Headset Operator
Set tractor parking brake.		x	
Request Brake Operator to set the aircraft parking brake.		x	x
Set the aircraft parking brake and check the pressure. Inform the Tractor Driver/Headset Operator: PARKING BRAKE SET, PRESSURE CHECKED.	x		
Inform the Control Tower that towing is completed and the frequency will be left (depending on local regulations).	x	x	x
Chock the aircraft MLG.		x	x
Switch off the external and anti-collision lights of the aircraft.	x		
Inform Brake Operator: AIRCRAFT CHOCKED.		x	x
Request permission from Brake Operator to disconnect the towbar or tractor.		x	x
Give permission to disconnect the towbar or tractor.	x		
Disconnect the towbar or tractor and remove the bypass pin/steering disengagement switch.		x	x
Chock the aircraft NLG.		x	x
Inform: AIRCRAFT STABILISED.		x	x
Release the aircraft parking brake and inform: PARKING BRAKE OFF.	x		
Check the NLG for damage.		x	x
After permission from the Brake Operator shut down and disconnect the tractor GPU (if applicable).		x	
Position and connect a GPU (if applicable).		x	x
Remove and stow gear safety pins at the dedicated location in cockpit.	x	x	
The required Walk-Around Check (see note below) is completed as described in chap. 7.1.5 WALK-AROUND CHECK.		x	x

7.3.8.5 Procedure for incident during Towing

INCIDENT	ACTION	
	Brake Operator	Tractor Driver/Headset Operator
VHF communication failure		<ul style="list-style-type: none"> - Stop aircraft/tractor set immediately. - Apply tractor parking brake. - Advise Towing Regulation and wait for assistance (flyco, Follow me before complete the towing).
Tractor failure	<ul style="list-style-type: none"> - Inform ATC. - Apply parking brake. - Listen to VHF and wait for assistance 	<ul style="list-style-type: none"> - Inform Brake Operator. - Stop aircraft/tractor set. - Apply tractor parking brake. - Chock the aircraft (if applicable). - Advise Dispatcher and wait for assistance (flyco, Follow me before complete the towing).
Coupling break-off	<ul style="list-style-type: none"> - Brake the assembly by stepping on both brake pedals progressively using gentle brake applications. - As soon as the aircraft is at a standstill, apply the parking brake before releasing the pedal. 	<ul style="list-style-type: none"> - Inform Brake Operator. - The tractor must not be braked. - Follow the aircraft path attentively and stop the tractor according to the aircraft position. - Chock the aircraft.
Tractor fire	<ul style="list-style-type: none"> - Inform ATC. - Apply parking brake. - Leave aircraft using the emergency exits. 	<ul style="list-style-type: none"> - Inform the Brake Operator. - Advise dispatcher (if possible). - Stop aircraft/tractor set immediately. - Move tractor away as rapidly as possible.
Aircraft fire	<ul style="list-style-type: none"> - Apply parking brake. - Inform ATC. - Apply parking brake. - If possible, fight the fire with the on board fire extinguisher. - Evacuate the aircraft using on board means, if required. 	<ul style="list-style-type: none"> - Stop aircraft/tractor set immediately. - Move tractor away as rapidly as possible. - Chock the aircraft.
Crash with other aircraft or vehicle	<ul style="list-style-type: none"> - Contact the Control Tower stating position and nature of trouble. - Listen to VHF and wait for assistance. - Wait for instructions by Tractor Driver/Headset Operator. 	<ul style="list-style-type: none"> - Stop aircraft/tractor set immediately. - Apply tractor parking brake. - Advise towing regulation. - Do not unload or disconnect the aircraft. - Chock the main landing gear.
Over torque / over steering alarm amber (caution)	<ul style="list-style-type: none"> - Wait for instructions by Tractor Driver/Headset Operator. 	<ul style="list-style-type: none"> - Stop aircraft/tractor set. - Line up aircraft/tractor set till the caution is off. - Continue towing once the caution is off.
Over torque / over steering alarm red (caution)	<ul style="list-style-type: none"> - Wait for instructions by Tractor Driver/Headset Operator. 	<ul style="list-style-type: none"> - Inform Brake Operator. - Stop aircraft/tractor set. - Inform Crew/Operations/Control/Maintenance Department/etc. - Do not move back the aircraft to the parking stand before the aircraft maintenance inspection and agreement. - Maintenance Department takes charge of the aircraft. - GSE Maintenance Department takes charge of the tractor.



Caution:

The Tractor Driver/Headset Operator and Brake Operator must continuously keep each other informed.

 ITA AIRWAYS Volume II HLM	AIRCRAFT GROUND MOVEMENT	7.4	Page 1
	HAND SIGNALS	Ed 2/20 apr 2022	

7.4 HAND SIGNALS

7.4.1 INTRODUCTION

In order to standardize Ground Staff - Ground Staff communication or Ground Staff - Flight Deck communication, the following hand signals are defined:

- **Guide Man Hand Signals**
to be used by a specific guide man in visual contact with the GSE and/or equipment operator to facilitate movements of any type of GSE and/or equipment operated in close proximity to the aircraft.
- **Marshalling (Taxi-in and Taxi-out) Hand Signals**
to be used by Ground Staff, to assist the Flight Deck during manoeuvring of the aircraft and engine starting.
- **Technical / Servicing Hand Signals**
to be used by Ground Staff to communicate technical/servicing information to Flight Deck, and by Flight Deck to communicate technical / servicing information to Ground Staff.
- **Pushback (NLG / MLG) or Towing Hand Signals**
to be used during the tractor/towbar connection/disconnection process, and at the start and end of the pushback/towing operation.
- **Wing Walker Hand Signals**
to be used by Ground Staff, to assist the Marshaller and/or the tractor Driver during manoeuvring of the aircraft.

7.4.1.1 Conditions for using hand signals

- Perform standard hand signals in clear and precise manner only if you have been trained and authorized.
- Wear high visibility vest.
- Maintain the same role throughout the procedure.
- Keep in constant, visual contact with the other Ground Staff and/or Flight Deck throughout the manoeuvre. If visual contact is lost, the operation must stop and not re-commence until visual contact is re-established.
- Remain clear of the intended pathway of the GSE/aircraft where possible.

7.4.2 GUIDE MAN HAND SIGNALS (FOR GSE)

- Every approaching/removal manoeuvre of GSE to/from the aircraft must be conducted with the assistance of a Guide Man.
- The Guide Man is positioned so that clearance from the aircraft, other equipment, vehicles or facilities can be accurately judged and signals can be visually communicated to the GSE operator.



Caution:

To avoid any possible confusion by the Flight Deck, do not use Guide Man hand signals for equipment until all aircraft marshalling has been completed.

To Attract Operator's Attention and Take Command:

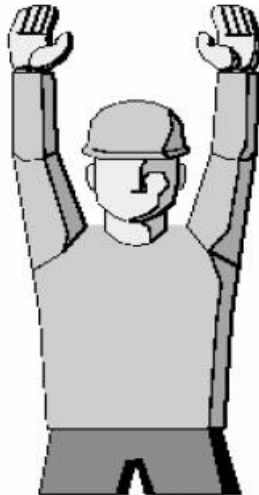

Arms held above head in vertical position with palms, facing forward.
Meaning: I am in charge of this maneuver.
You will take orders only from me.

To End Command:

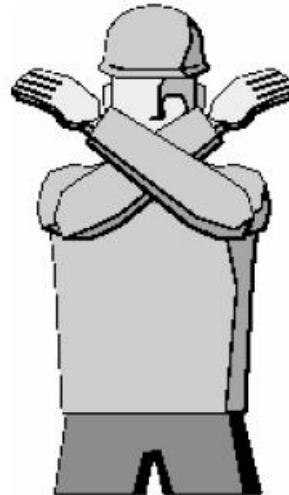

Arms crossed on chest.
Meaning: I am no longer giving you orders.

Forward Movement (Toward man):



Arms a little aside and repeatedly moving upwards, backwards, beckoning onwards.

Backward Movement:

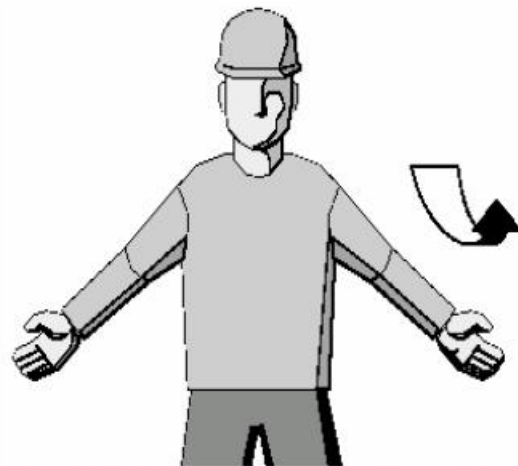

Arms by sides, palms facing forward, swept forward and upward repeatedly.

Turn Right:

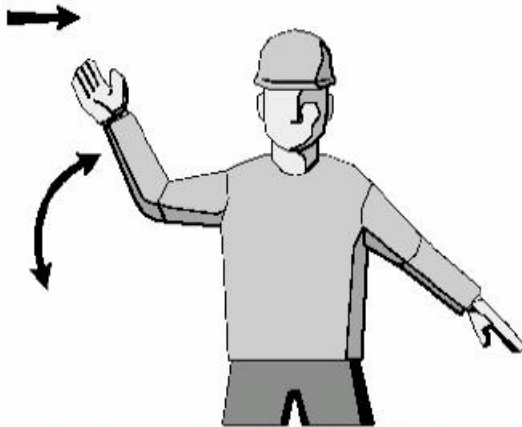

Left arm downward, hand extended, right arm repeatedly moved upward backward. Speed of arm movement indicating rate of turn.

Turn Left:

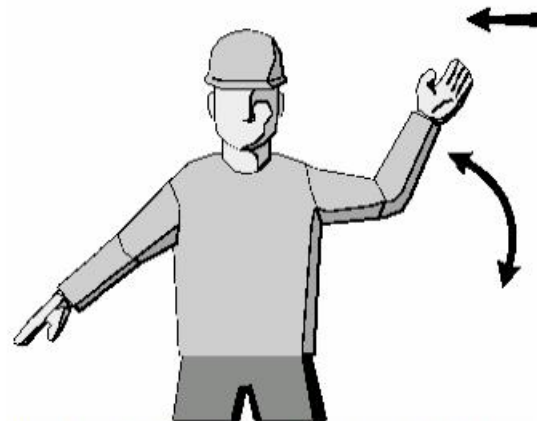

Right arm downward, hand extended, left arm repeatedly moved upward backward. Speed of arm movement indicating rate of turn.

Lift:

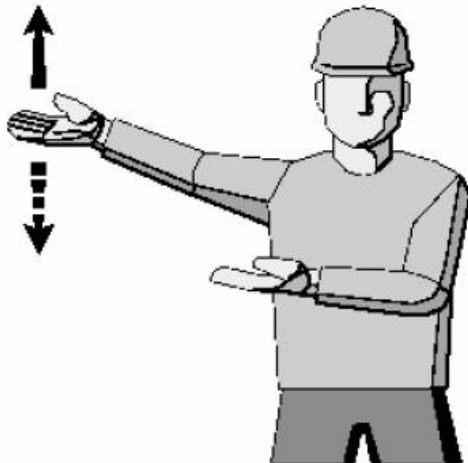

Stretch both arms toward load or equipment, palm up, hand movement in upward direction.

Lower:

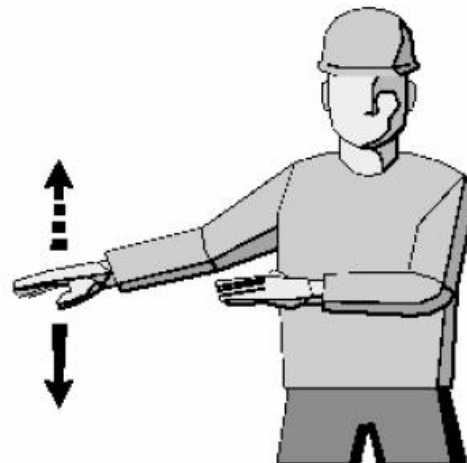

Stretch both arms toward load or equipment, palm down, hand movement in downward direction.

Accompanied Movement:

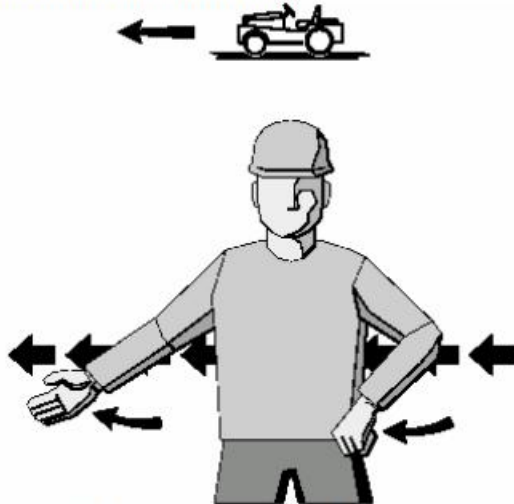

Come with Load or equipment. Maintain eye to eye contact with operator or driver. Swing down opposite arm.

Stop:



Arm repeatedly crossed above head (the speed of the arm movement must be related to the urgency of the stop).

Immediate stop: Hands cross over head with clenched fists.

Indicate Distance:



Distance shown between hands must correspond exactly with existing margin.

OK. All is Clear
 or continue by Your Own
 or Drive Away:



Lift stretched right arm, hand closed, thumb raised.

Chocks Inserted; Stabilizers On:

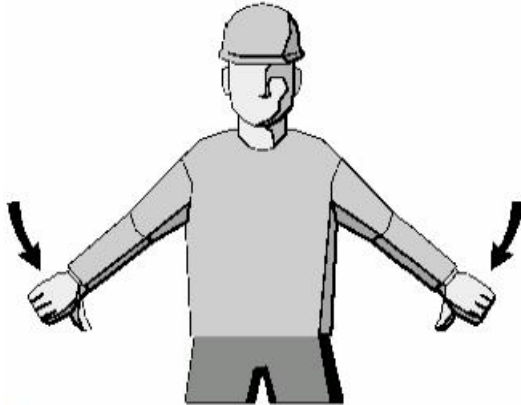

Arms down, hand closed facing inward, thumbs extended, move arms inwards.

Chocks Removed; Stabilizers Off:

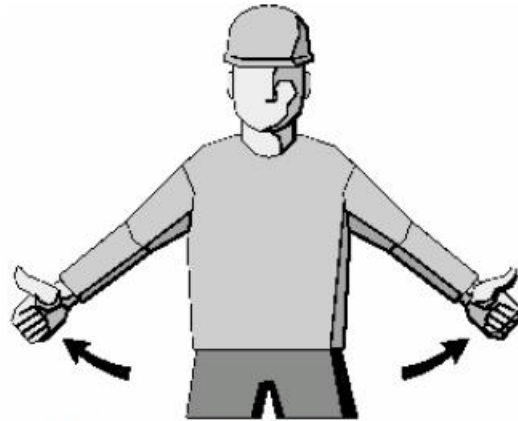

Arms down, hands closed facing outward, thumbs extended, move arms outward.

**To Interrupt Power Source
(Electricity, Fuel, Air):**



Right arm and hand level with shoulder, palm downward horizontally swinging from extended arm to throat.

Stop Engine:

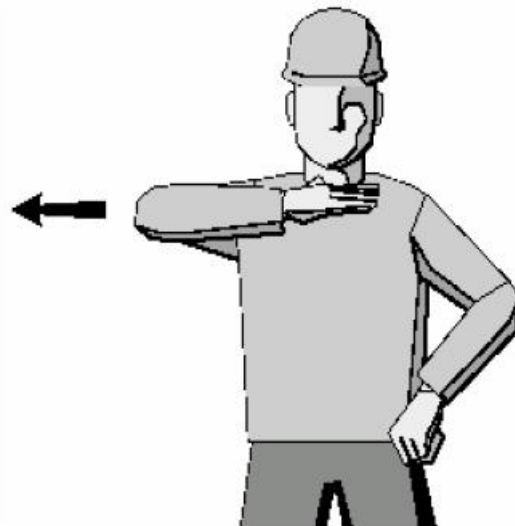

Right arm and hand level with shoulder, palm downward, hand on throat making horizontal move to the right, passing hand across throat.

To Connect or Disconnect:

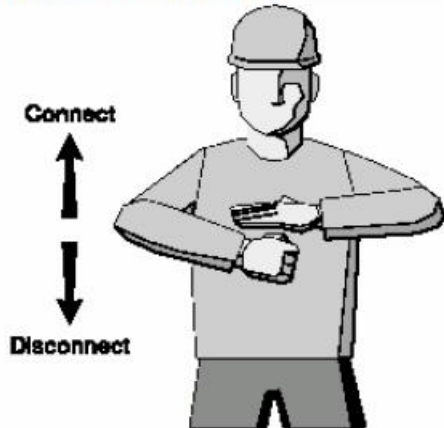

Raise left arm and hand, with fingers extended horizontally.

Connect: Right hand with clenched fist moving upward to contact left palm.

Disconnect: Right hand with clenched fist leaving left palm downward.

Brakes On/Off:

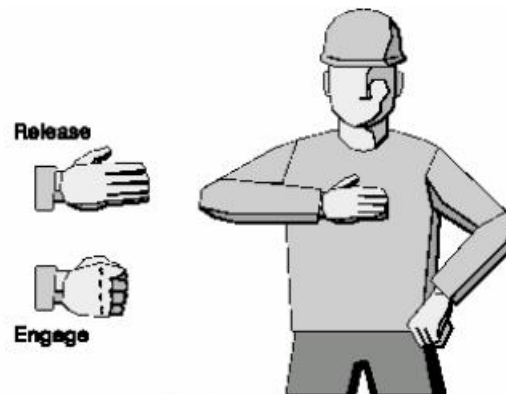

Right arm and hand raised horizontally in front of body.

Release brakes: With fist clenched, then extend fingers, palm inward.

Engage brakes: With extended fingers, palm inward, then clench fist.

 Volume II HLM	AIRCRAFT GROUND MOVEMENT	7.4	Page 7
	HAND SIGNALS	Ed 2/20 apr 2022	

7.4.3 OTHER OPERATIONS HAND SIGNALS

- Utilize high visibility wands, paddles or gloves during daytime conditions.
- Use illuminated wands in the following situations:
 - insufficient apron lighting,
 - poor visibility,
 - night conditions,
 - when required by local Airport Authorities or regulations.

7.4.3.1 Marshalling (Taxi-in and Taxi-out) hand signals

- Perform marshalling functions only if it is approved by the local relevant authority.
- Give marshalling hand signals from a position forward of the aircraft while facing and within view of the pilot.
- Wear a fluorescent identification vest or jacket to permit positive identification by the Flight Deck.

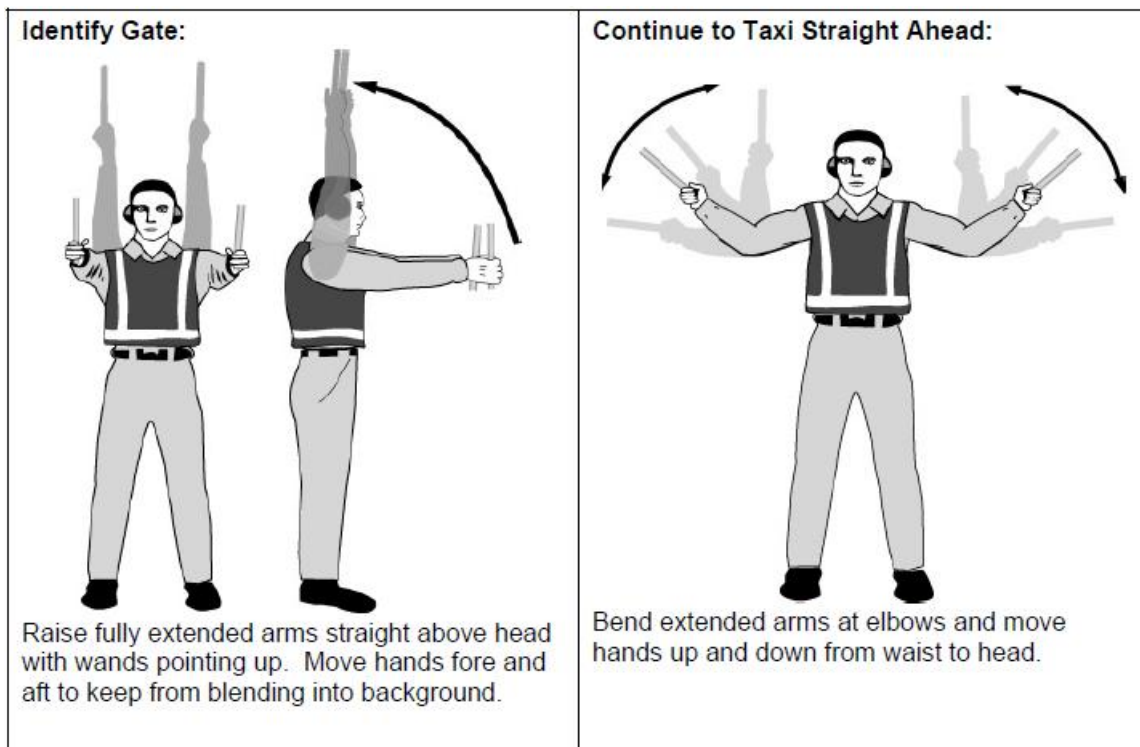

Slow Down:

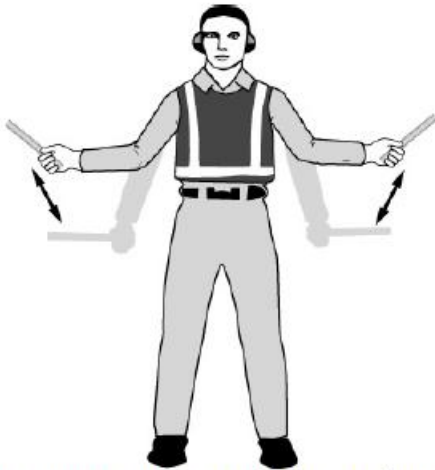

Move extended arms downwards in a "patting gesture", moving wands up and down from waist to knees.

Turn Right (from the pilot's point of view):

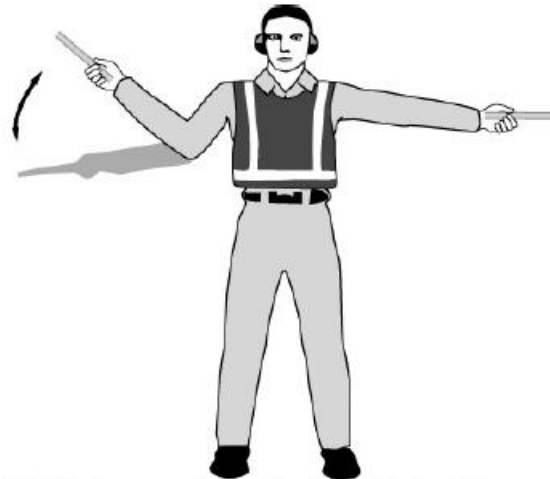

With left arm and wand extended at a 90° angle to the body, right hand makes the come ahead signal. The rate of signal motion indicates to the pilot the rate of aircraft movement desired.

Turn Left (from the pilot's point of view):

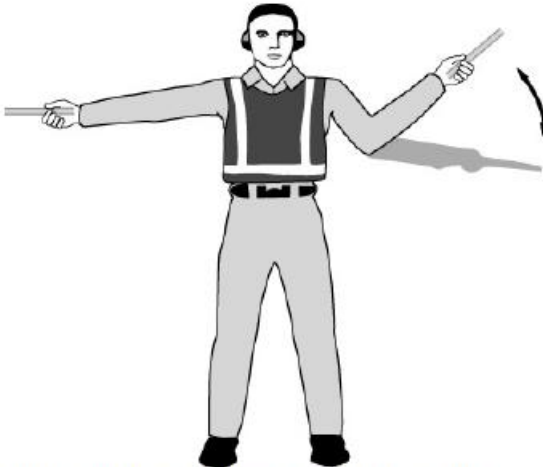

With right arm and wand extended at a 90° angle to the body, left hand makes the come ahead signal. The rate of signal motion indicates to the pilot the rate of aircraft movement desired.

Stop/Emergency Stop:

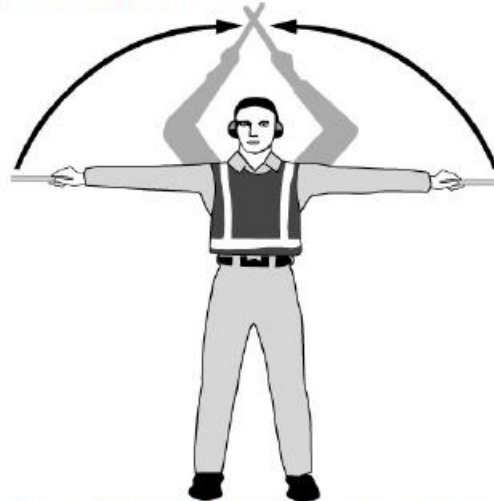

Fully extend arms and wands to cross above the head.

Hold Position / Standby:

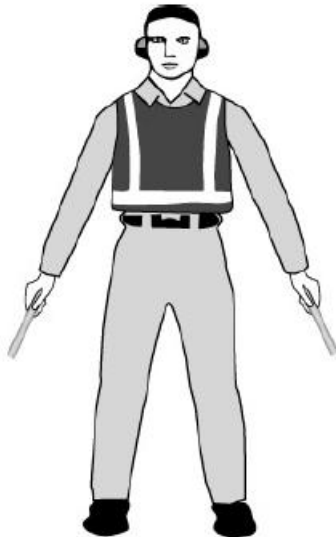

Fully extend arms and wands downwards at a 45° angle to the sides. Hold the position until the aircraft is clear for the next maneuver.

Proceed to Next Marshaller or as Directed by Tower/Ground Control:



Point both arms upward, move and extend arms outward to side of body and point with wands to direction of next marshaller or taxi area.

End Marshalling / All Clear:

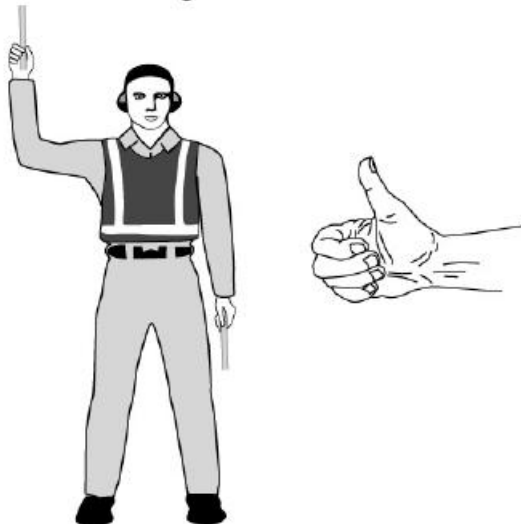

Raise right arm to head level with wand pointing up or display hand with thumbs up, left arm remains at side by knee, if applicable display steering bypass pin to flight crew.

Fire:

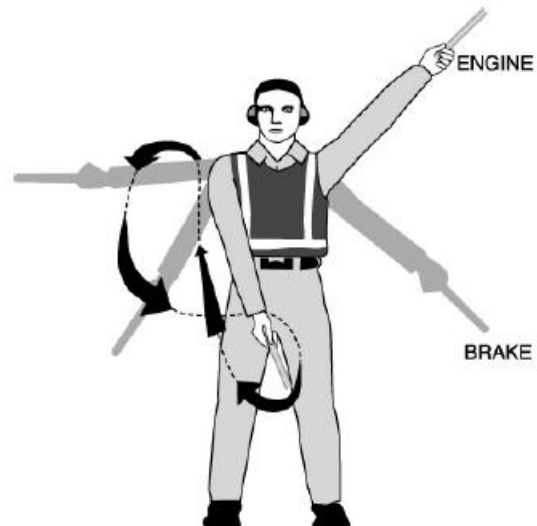

Move right hand in an exaggerated figure of eight (8), or a fanning type motion, from the shoulder to the knee, while at the same time pointing with the left-hand wand to the area of the fire.

Set Brakes:

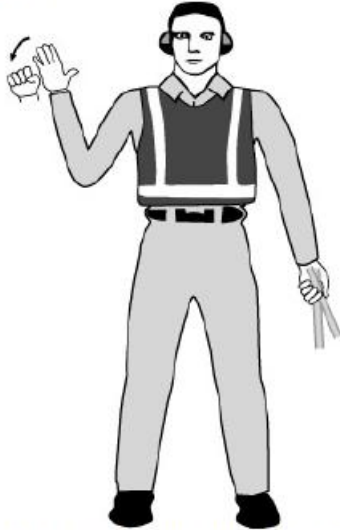

Raise hand just above shoulder height with open palm. Ensuring eye contact with the flight crew, close hand into a fist.

→ **DO NOT** move until receipt of thumbs up acknowledgment from the flight crew.

Release Brakes:

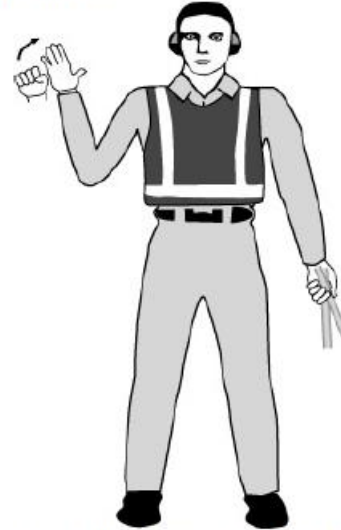

Raise hand just above shoulder height with hand closed in a fist. Ensuring eye contact with the flight crew, open palm.

→ **DO NOT** move until receipt of thumbs up acknowledgment from the flight crew.

Chocks Inserted:



With arms and wands fully extended above head, move wands inward in a "jabbing" motion until the wands touch.

Chocks Removed:



With arms and wands fully extended above head, move wands outward in a "jabbing" motion.

Start Engines:



Raise right arm to head level with wand pointing up and start a circular motion with hand, at the same time with the left arm raised above head level point to aircraft.

Emergency Engine Shutdown:

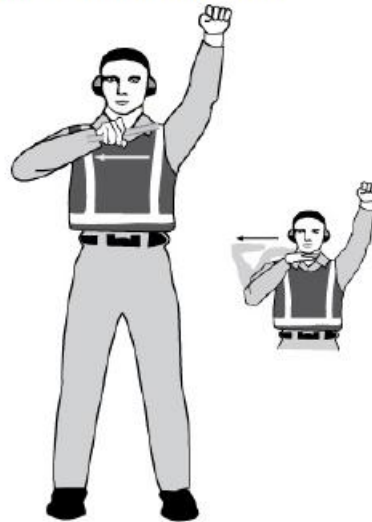

Extend arm with wand forward of body at shoulder level, move hand and wand to top of left shoulder and draw wand to top of right shoulder in a slicing motion across throat.

 ITA AIRWAYS Volume II HLM	AIRCRAFT GROUND MOVEMENT	7.4	Page 12
	HAND SIGNALS	Ed 2/20 apr 2022	

7.4.3.2 Technical/servicing hand signals - Ground Staff to Flight Deck

- Only use manual signals when verbal communication is not possible.
- Make sure acknowledgement is received from the flight crew on all occasions.

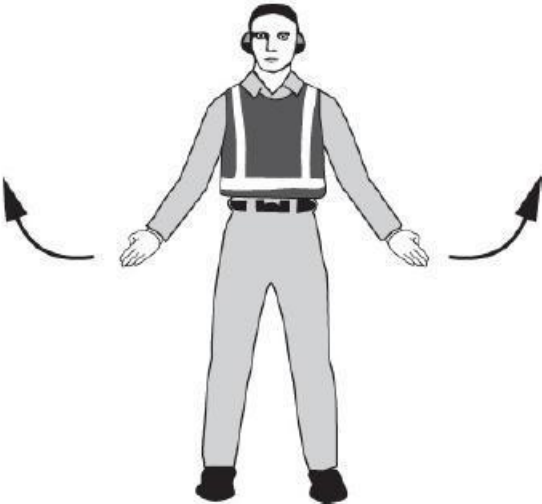
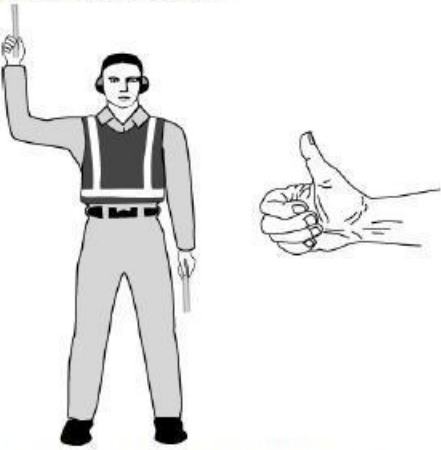
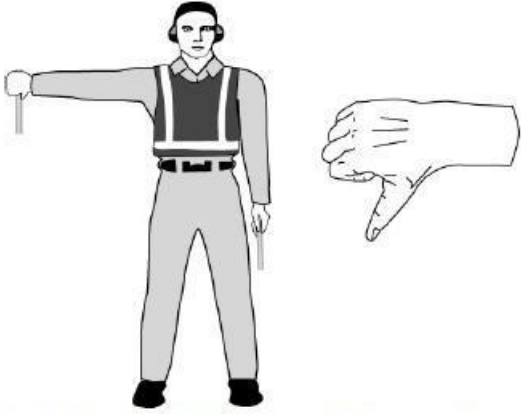
<p>Connect Towbar:</p>  <p>Bring arms above the head and grasp forearm with opposite hand.</p>	<p>Air Up (supply pressurized air for engine start):</p>  <p>Wave arms up & down from thigh to waist with palms up. NOTE – to be checked</p>
<p>Affirmative / All Clear:</p>  <p>Raise right arm to head level with wand pointing up or display hand with thumbs up, left arm remains at side by knee, if applicable display steering bypass pin to flight crew.</p>	<p>Negative:</p>  <p>Hold right arm straight out at 90° from shoulder and point wand down to ground or display hand with thumbs down, left hand remains at side by knee.</p>

Connect Ground Power:

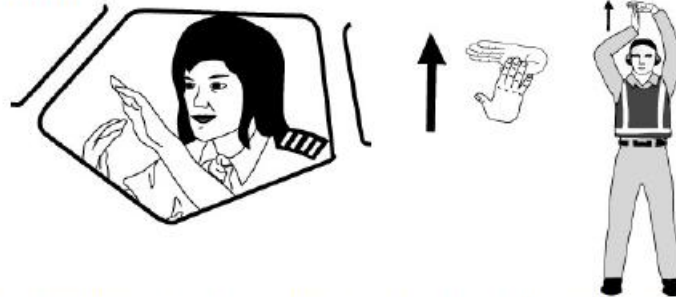

Hold arms fully extended above head, open left hand and move finger tips of right hand into and touch the open palm of the left hand (forming a "T"). At night, illuminated wands can also be used to form the "T" above the head.

Disconnect Ground Power:

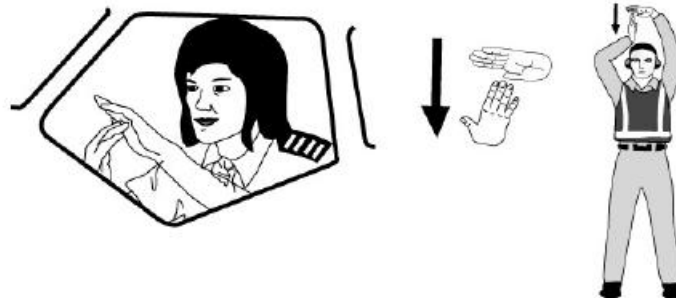

Hold arms fully extended above head with finger tips of right hand touching the open horizontal palm of the left hand (forming a "T"), then move the right hand away from the left. At night, illuminated wands can also be used to open the "T" above the head.

→ **DO NOT** disconnect power until authorized to do so by the flight crew.

Interphones:



Extend both arms at 90° from body and move hands to cup both ears.

Do Not Touch Controls &/or Brakes

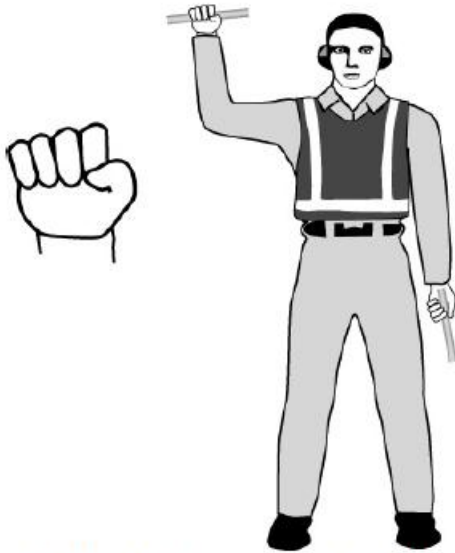

Raise right hand above head level and close fist or hold wand in horizontal position, left arm remains at side by knee.

Open / Close Stairs Forward / Aft:



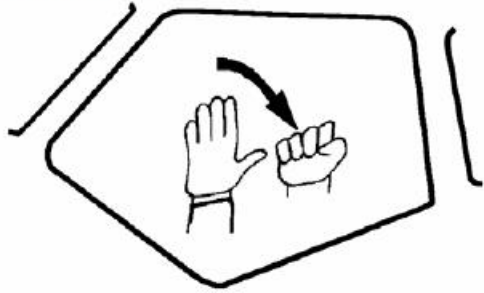
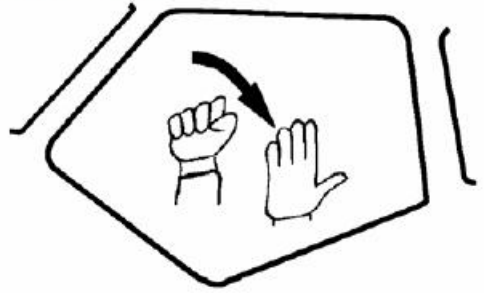
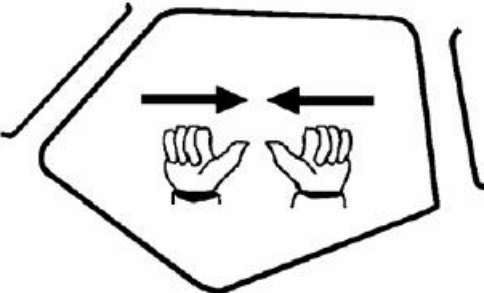
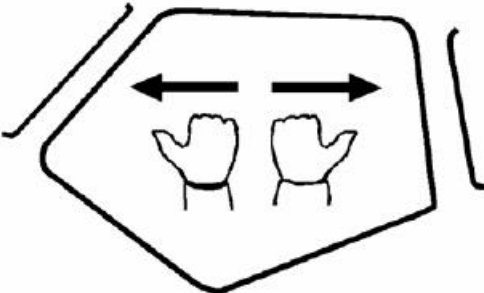
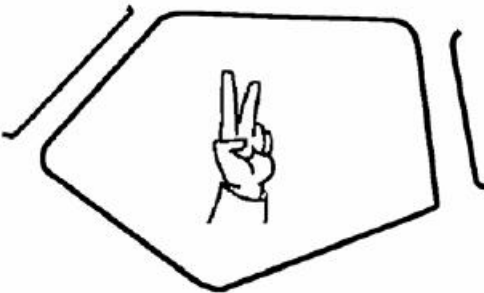
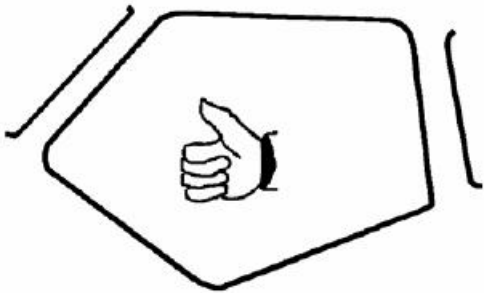

With right arm at side and left arm raised above head at a 45° angle, move right arm in sweeping motion towards top of left shoulder.

7.4.3.3 Technical/servicing hand signals - Flight Deck to Ground Staff

<p>Brakes Engaged:</p>  <p>Raised arm and hand, with fingers extended, horizontally in front of face. Hand is then closed to a fist.</p>	<p>Brakes Released:</p>  <p>Raised arm, with fist clenched, horizontally in front of face. Hand is then opened to an open palm.</p>
<p>Insert Wheel Chocks:</p>  <p>Arms extended, palms outwards, and hands moving inwards.</p>	<p>Remove Wheel Chocks:</p>  <p>Hands crossed in front of face, palms outwards, and arms moving outwards.</p>
<p>Ready to Start Engine (s):</p>  <p>One hand raised with the appropriate number of fingers stretched indicating the number of the engine to be started.</p>	<p>All Clear:</p>  <p>Acknowledgement of all ground actions.</p>

 Volume II HLM	AIRCRAFT GROUND MOVEMENT	7.4	Page 16
	HAND SIGNALS		Ed 2/20 apr 2022

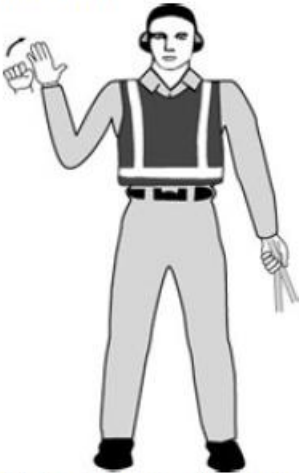
7.4.3.4 Pushback (TT-TBL-MGT) / Towing (TT-TBL) hand signals - Headset Operator to Tug Driver

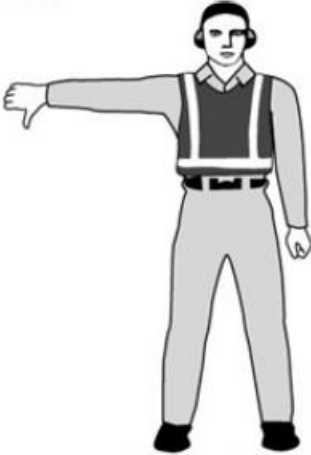
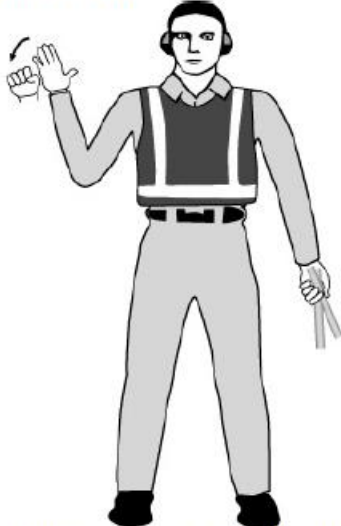
<p>Vehicle Brakes Off:</p>  <p>Raise hand just above shoulder height with closed fist and ensuring eye contact with tug driver open palm.</p>	<p>Clear to Push:</p>  <p>Hold arm straight out at a 90° angle from the shoulder and display hand with thumb up. This indicates to the tug driver that all equipment is clear of the aircraft, the chocks have been removed, the aircraft brakes are off and the flight crew has given clearance to commence pushback.</p>
<p>Negative / Hold:</p>  <p>Hold arm straight out at 90° angle from the shoulder and display hand with thumb down. This indicates to the tug driver that the aircraft is not ready for pushback and to hold position.</p>	<p>Vehicle Brakes On</p>  <p>Raise hand just above shoulder height with open palm and ensuring eye contact with tug driver close into a fist. At the end of the pushback also indicates to tug driver that aircraft brakes have been set. Tug driver should return the signal to the Headset operator to confirm vehicle brakes set.</p>

Slow Down:



With hand at a 45° angle downward to the side make a "patting" motion.

Change of Pushback Direction:





Touch nose with finger and with arm at a 90° angle to the shoulder, point in the direction that the aircraft needs to be turned to.

 ITA AIRWAYS Volume II HLM	AIRCRAFT GROUND MOVEMENT	7.4	Page 18
	HAND SIGNALS	Ed 2/20 apr 2022	

7.4.3.5 Wing Walker hand signals - to Headset Operator and/or Tug Driver

- Perform or wing walker functions only if it is approved by the local relevant authority.
- Wear a fluorescent identification vest or jacket to permit positive identification by the Flight Deck.

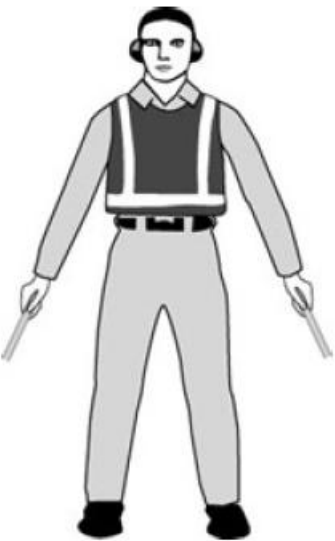
<p>Clear to Move Aircraft:</p>  <p>Raise one fully extended arm with wand straight above head and with the other arm and wand at a 45° angle downward to the side.</p>	<p>Stop Movement of the Aircraft:</p>  <p>Fully extend arms and wands to cross above the head.</p>
<p>Hold Movement of the Aircraft:</p>  <p>Fully extend arms and wands downwards at a 45° angle to the sides. Hold this position until it is clear for the aircraft to move.</p>	

RAMP HANDLING

 Volume II HLM	RAMP HANDLING	8.1	Page 1
	GENERAL	Ed 2/20 apr 2022	

8.1 GENERAL

Aircraft damage can endanger passengers, crew and employees. Disruptions may also negatively impact safe airline operations, any slight scratch or dent in on aircraft may result in a serious accident. Any aircraft damage caused or found **MUST BE** reported (see GOM - Introduction - 0.0 Reporting System).

Improper working behavior may also results is serious personal injury. Ramp safety rules and procedures ensure safe ground handling; therefore the minimum safety rules and procedures mentioned in this chapter shall always be understood and applied while working on the ramp.

8.1.1 WORK SAFETY PREACUTION

- Only qualified personnel is allowed to use equipments. Such personnel must have appropriate physical and psychological requirements (physical fitness, eyesight, colour vision, depth perception and hearing).
- Use of alcohol and/or psychoactive substances is strictly prohibited.
- Appropriate PPE (personal protective equipment) as gloves and safety shoes, high visibility clothes, hearing protection, safety glasses, face protection etc. shall be always worn as per job role.
- The wearing of jewellery such as rings and bracelets shall be discouraged: they are prone to catch on hooks, nails, buckles, locks or straps, and have been known to damage limbs severely, even to sever them completely.
- Only quick release (clip) type neckties shall be worn.
- Loading personnel shall never attempt weights beyond their physical capabilities. Lifting shall be done using arms and legs. The back shall be kept as straight as possible.
- Handling cargo by the metal strapping which is frequently employed to bind heavy or awkward items, shall be avoided.
- When handling live animal, fingers and hands should be kept clear of the interior of cages or crates.
- Personnel shall stand clear when a train of carts/dollies passes.
- Personnel shall not walk between ULDs and carts which are being transported by a vehicle.
- Carts and ULDs shall be opened carefully. load, falling outside, could cause serious injuries.
- Load shall be positioned carefully inside the aircraft (without allowing it to drop), to avoid injuries to the limbs as well as to prevent damage to aircraft flooring or other shipment.
- Load shall be stowed evenly in carts, with heavy pieces on the bottom and in the centre to ensure stability. All doors, gates and coverings shall be secured to prevent load from falling out.
- If ULDs are transported on dollies, always check and engage the locks.
- Do not walk over rotating surfaces.
- When attaching carts to tractors, employees shall make sure the fittings are properly locked.

 Volume II HLM	RAMP HANDLING	8.2	Page 1
	NO TRANSIT CHECK	Ed 2 Rev 6/15 nov 23	

8.2 NO TRANSIT CHECK

8.2.1 INTRODUCTION

The “No Transit Check” procedure is consists in the distribution of the tasks normally performed by maintenance personnel, between Flight Crew and qualified Ground Handling personnel (Fuel Provider and Ground Staff).

The “No Transit Check” procedure is applicable to ITA aircraft A321, A320 and A220.

 Volume II HLM	RAMP HANDLING	8.2	Page 2
	NO TRANSIT CHECK	Ed 2 Rev 5/02 nov 23	

8.2.2 GROUND STAFF DUTIES

The Ground Staff (appropriately trained and qualified) shall provide assistance, the following activities:

- a. Aircraft Movement (aircraft pre-arrival, arrival, pre-departure servicing check, engine start).
The procedures are described in Chap. 7.
For pre-departure checks refer to PRE-DEPARTURE SERVICING CHECK LIST (chap. 5.X.X).

Note:

It is allowed to start the checks even if the cabin access means are still in contact with the aircraft. Completion of the Pre Departure Servicing Check List must be reported to the Flight Deck by the announcement: "PRE DEPARTURE SERVICING CHECKS COMPLETED".

- a. Fuelling.
The procedures are described in Chap. 8.6 REFUELLING.
- b. De/Anti-Icing.
If the Captain requests a "De/Anti-Icing" treatment, the Ground Staff shall call the authorized de/anti-icing Service Provider.
If the Service Provider is not qualified to perform the "Post De/Anti-Icing Check", the Ground Staff shall inform the Captain and call a qualified person.
- c. Documents collection.

8.2.2.1 Documents collection

The Ground Staff receives from the Captain:

- The ATL (for ITA) and ACL (for ITA) YELLOW pages, related to the last flight.

Note: The ATL and ACL YELLOW pages, related to the last flight only shall be delivered to the Maintenance Technician if he performed any maintenance task on the aircraft.

The Ground Staff shall deliver the ATL and ACL pages:

- to the Ramp Operations Control Center (Load Control) at FCO and LIN Airports;
- to the Station Manager elsewhere.

WARNING

Delivery and filing of the ATL pages
are MANDATORY.

 ITA AIRWAYS Volume II HLM	RAMP HANDLING	8.3	Page 1
	GROUND OPERATIONS SUPERVISION AND SAFETY	Ed 2/20 apr 2022	

8.3 GROUND OPERATIONS SUPERVISION AND SAFETY

8.3.1 EQUIPMENT RESTRAINT AREA & EQUIPMENT RESTRAINT LINE

The Equipment Restraint Area (ERA) is defined as the area of the apron bordered by a red line known as the Equipment Restraint Line in which an aircraft is parked during ground operations.

The ERA must be free of obstructions and Foreign Object Debris (FOD) before aircraft arrival and departure.

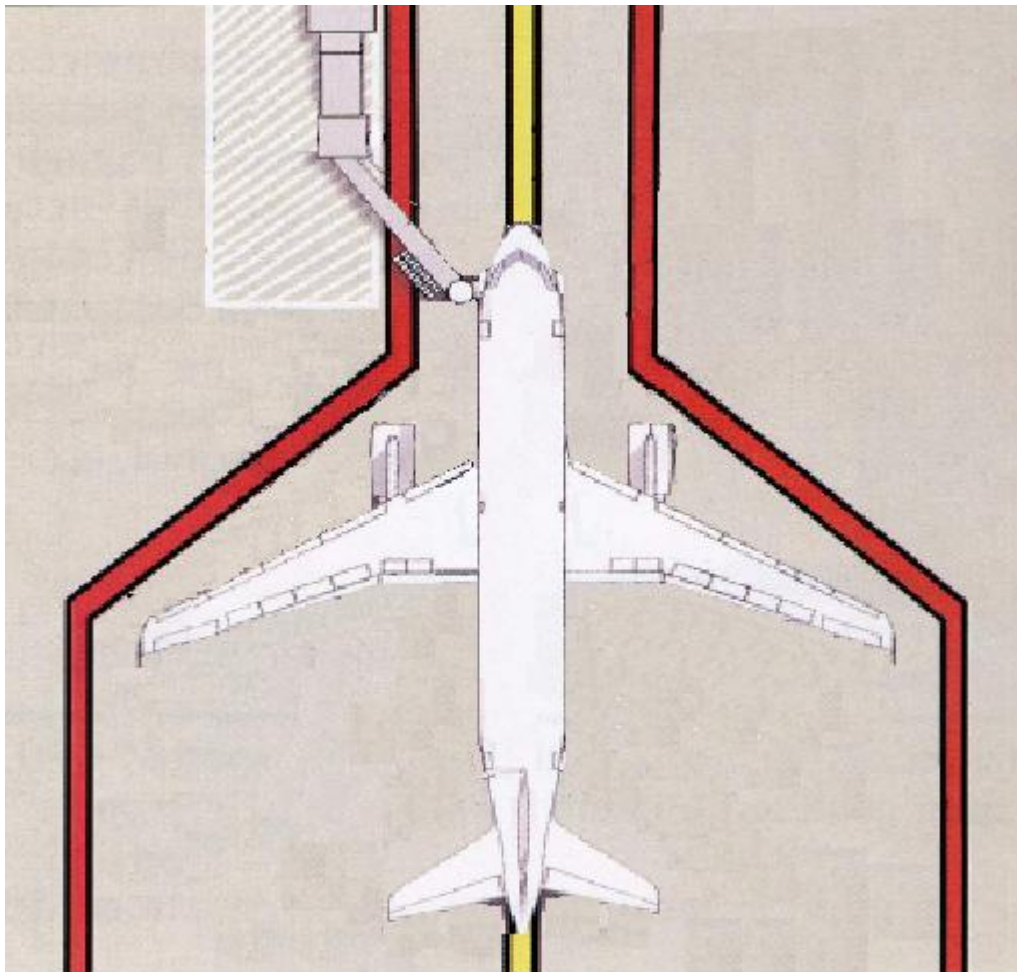

 Volume II HLM	RAMP HANDLING	8.3	Page 2
	GROUND OPERATIONS SUPERVISION AND SAFETY	Ed 2 Rev 8/15 mar 24	

8.3.2 AIRCRAFT CHOCKING

Chocks are needed to prevent aircraft movements when parked, while parking brake is not engaged.

8.3.2.1 Chocks placement and removal

1. Make sure that adequate numbers of chocks are available for the aircraft arriving considering:
 - aircraft type,
 - parking slope,
 - weather conditions.
2. One designated member of the Ground Staff shall:
 - a. place immediately chocks forward and aft of the nose gear (except A/C with spray deflector). This action shall be completed before any other activity may take place (see HLM 7.2.2).
 - b. do not approach aircraft main landing gear unless all of the following criteria are met:
 - aircraft has come to a complete stop,
 - engines have been switched off and are spooling down,
 - anti-collision lights are switched off.
 - c. Walk towards the main gear in a path parallel to the fuselage and place chocks (see HLM Chap 5.x.x).
3. Chocks should not be removed from aircraft until clearance is given by the Captain or ground staff responsible for departure (see HLM Chap.7).
4. In order to avoid FOD, chocks shall be stored in to a designated area outside the ERA.



Caution:

When placing wheel chocks

- Stand well clear of the path of the tires, as serious injury could occur if the aircraft begins to roll prior to the final placement of the chocks.
- Approach/leave the main landing gear from the front or rear. This minimizes the risk of serious injury since aircraft tires are designed to burst in the direction of the wingtips.



Caution:

in case of wind conditions over 25 kt (46.3 km/h) position chocks as specified for each type of aircraft in chp. 5

 Volume II HLM	RAMP HANDLING	8.3	Page 3
	GROUND OPERATIONS SUPERVISION AND SAFETY	Ed 2/20 apr 2022	

Note:

- When inserting wheel chocks, position one chock in the center in front and one behind the tire(s), parallel to the wheel axle and only lightly touching the tire. For double axle gears the chocks are positioned forward of the front tire and aft of the rear tire on the gear.
- If the aircraft is parked on a slope:
 1. Place the chocks firmly against the down side of the tire.
 2. Eliminate space between a wheel chock and the tire to reduce the chances that the aircraft will "jump" a wheel chock by getting a rolling start.
 3. If towbarless tractor shall be used for departure, is allowed to remove nose gear chocks once main gear chocks are placed. In this case is mandatory to place additional chocks on main landing gears (A320F)

 Volume II HLM	RAMP HANDLING	8.3	Page 4
	GROUND OPERATIONS SUPERVISION AND SAFETY	Ed 2/20 apr 2022	

8.3.3 SAFETY CONES

Safety cones are a caution sign for drivers to maintain required safety clearances. Cones protect parts of the aircraft against collision by GSE and/or vehicles.

8.3.3.1 Marker cones placement and removal

1. Prior to the arrival of the aircraft, make sure there are sufficient serviceable safety cones to protect the aircraft type to be handled.
2. Do not approach aircraft to position cones unless all of the following criteria are met:
 1. aircraft has come to a complete stop
 2. engines have been switched off and are spooling down
 3. anti-collision lights are switched off
 4. aircraft has been chocked
3. Place marker cones on the ground in accordance with Company instructions and aircraft type (see HLM chap.5.x.x for ITA) - within a maximum of one meter outward from the point of the aircraft being protected. Additional marker cones may be needed as per operational requirements or local regulations.
4. Make sure all required marker cones shall remain in place until GSE and vehicular activities around the aircraft have ceased prior to departure of the aircraft and all ground service equipment has been removed from the safety zone.
5. Remove the marker cones and place them in designated areas for storage.

8.3.4 DANGER AREAS

There is a particular risk of blast damage or injury from an aircraft engine's exhaust or intake. The risk is increased if an aircraft stops and then applies the additional thrust required to "break away". Vehicles and personnel must remain clear of aircraft danger Areas when aircraft engines are running



Caution:

In order to prevent incidents and accidents caused by aircraft engines, you must never position yourself or equipment in the following critical areas during aircraft departure, arrival and taxi.

- Engine Intake area
- Engine Blast area
- Propeller rotation area (where applicable)

The length of these Areas vary for each aircraft type based on whether the engines are at idle or breakaway thrust.

8.3.4.1 Engines Intake/Blast areas

Make sure the engine Intake/Blast area is clear:

- at arrival, until the engines have been turned off and are spooling down,
- at departure or just before pushback,
- at all times when the engine is running.



Caution:

It is forbidden to pass behind aircraft while engines running.

 ITA AIRWAYS Volume II HLM	RAMP HANDLING	8.3	Page 5
	GROUND OPERATIONS SUPERVISION AND SAFETY	Ed 2/20 apr 2022	

8.3.5 FOD - FOREIGN OBJECT DEBRIS

Foreign Object Debris (FOD) is a general term which applies to all loose objects which are a danger to the safety and integrity of an aircraft and which, therefore, must not be left in any area so as to constitute a hazard.

Every individual has a responsibility to ensure that the risk of damage to aircraft from FOD is minimized; all FOD must be removed and properly disposed as soon as it is discovered.

Often the presence of FOD is due to carelessness of personnel working airside, their lack of understanding of consequences or the movement of FOD into airside locations during high winds.

Examples of FOD:

Plastic and paper, bags / sheets, rags.

Metal: nuts and bolts, empty oil and hydraulic fluid cans, tools and equipment.

Natural objects: rocks, pebbles and wood.

Other debris: burst ballast bags, luggage handles and luggage wheels, etc.



Results of FOD:

Foreign object debris may be ingested into aircraft engines causing damage leading to engine failure. This is especially critical if it occurs in flight, particularly if it occurs during the take-off or landing phase. In addition, damage caused by FOD can occur to tires, the undercarriage, control systems and other parts of the airframe leading to in-flight failures and inevitably requires expensive repairs to be made.

8.3.5.1 FOD checks

The following checks must be conducted prior to any operation:

- Check apron and gate areas.
- Check ground equipment staging and parking areas.
- Check ground equipment (including floor of enclosed cabins).
- Check baggage belt areas.
- Check any garbage dumpster areas for cleanliness.
- Ensure that anything that is carried in or on a vehicle is secured.
- Always conduct an Equipment Restraint Area (ERA) FOD check.
- Pick-up and dispose all FOD.

 Volume II HLM	RAMP HANDLING	8.3	Page 6
	GROUND OPERATIONS SUPERVISION AND SAFETY	Ed 2/20 apr 2022	

8.3.6 ADVERSE WEATHER CONDITIONS

Poor weather conditions may have a negative impact on aircraft handling activities and ground safety.

8.3.6.1 Winter or slippery apron conditions

Winter weather brings extra hazards which require more awareness and care on the part of personnel working on the aprons to prevent accidents. The following precautions to reduce accident risk must be taken as follows:

- Plan additional time for all ramp activities and take extra care when walking across apron surfaces which can be slippery.
- Take extra care when driving, especially when approaching the aircraft. When driving, remember that vehicles require a greater distance to stop safely.
- Operators of potable water tankers and toilet servicing vehicles must be vigilant that there is no spillage or leakage leading to subsequent freezing. Care must be taken to contain spillage and overflow to a minimum.
- Close all entrance and cargo compartment doors as soon as possible and keep closed to avoid water seepage or snow entry in the aircraft.
- Reduce speeds in slippery apron conditions. Adjust all activities and operations on the ramp to suit the conditions at the time.

8.3.6.2 Thunderstorms

Communication may implement alert phases, refer to local airport or operating airline thunderstorm policy. If not available, below a minimum standard to follow.

When lightning is present:

- Do not communicate with a connected communication headset with the flight deck. If necessary communicate using standard hand signals.
- Do not stay in open areas, under the aircraft loading bridge or near any pole.
- Stop all ground handling operations.



Caution:

Do not wear a headset connected to the aircraft during a thunderstorm or if a warning has been issued.

Note:

aircraft refuelling must immediately be stopped and is prohibited during thunderstorm activity.

 Volume II HLM	RAMP HANDLING	8.3	Page 7
	GROUND OPERATIONS SUPERVISION AND SAFETY	Ed 2/20 apr 2022	

8.3.6.3 High wind conditions

High winds pose great risks of damage and the following minimum precautions should be taken:

- Ensure the safety of the aircraft by installing additional chocks and removing all equipment from around the aircraft.
- Take extreme caution when opening or closing aircraft compartment doors.
- Make sure parking brakes are set on all parked GSE.
- Set parking brakes and secure by additional means if necessary all non-motorized ramp equipment. E.g. Baggage carts and ULD dollies.

8.3.6.3.1 High winds activity matrix

The following actions must be taken when sustained and or gusts of wind exceeding 25 KTS are predicted.

	from 25 to 40 KTS	from 40 to 60 KTS	> 60 KTS
Secure bag/freight carts, dollies, ladders/maintenance stands, and tow bars and place near or against the building	x	x	x
Ensure parking brakes are engaged on all ground equipment.	x	x	x
Ensure any empty ULDs are secured and curtains are closed	x	x	x
Clear FOD and remove all ULDs from the stands.	x	x	x
Empty FOD containers and bring inside if not secure	x	x	x
Suspend use of pre-conditioned air hoses and store securely, remove marker cones.	x	x	x
Ensure landing gear is chocked for high wind conditions.	x	x	x
Do not elevate cabin service/catering high lifts and passenger stairs not equipped with stabilizers.	x	x	x
Close all aircraft access panels.		x	x
Close cargo compartment/pax doors.		x	x
Do not elevate booms on deicers.		x	x
Remove GSE from aircraft and secure in position outside ERA clear of all aircraft.		x	x
Secure boarding bridge and position to minimize surface exposed to the direct force of the wind.		x	x
Retract and lower boarding bridge. Position so that boarding bridge length points away from the wind.			x

 ITA AIRWAYS Volume II HLM	RAMP HANDLING	8.3	Page 8
	GROUND OPERATIONS SUPERVISION AND SAFETY	Ed 2/20 apr 2022	

8.3.7 AIRSIDE FIRE SAFETY

8.3.7.1 Identification and elimination of condition that could lead to a fire

- Smoking is not permitted on any apron areas or in any vehicles in the apron.
- Good housekeeping in office is a must in order to eliminate the risk of fire.
- Garbage should not be allowed to accumulate, but should be disposed of into approved containers.
- If possible, close aircraft cargo doors and hatches.
- Do not refuel any GSE while engine is running.
- Do not refuel any GSE while in the ERA.
- Equipment should not be operated in the vicinity of a fuel spill.
- The use of any cell phone or mobile is not permitted under vent panels.
- Wearing of boots with steel tips showing, steel heels or nails in soles are not permitted.

8.3.7.2 Availability, access and use of fire-fighting equipment

- All staff shall be familiar with fire-fighting equipment, fire alarm, emergency shut off.
- Check availability of fire-fighting equipment in/on applicable GSE and vehicles before use.
- In office, emergency exits and access to fire protection system shall be kept clear.
- Access to fire-fighting equipment, fire alarms, emergency fuel hydrant shut off shall not be obstructed in any manner.
- Vehicles shall only be parked as follow:
 - within the defined equipment parking area,
 - in a manner that does not obstruct access to fire-fighting equipment and the fuel hydrant emergency stop switch.
- If fire is noticed in an equipment or vehicle:
 - it should be controlled utilizing the fire extinguisher in the equipment or the apron fire extinguisher,
 - move affected GSE/vehicle away from the aircraft and operational area to the extent practicable,
 - stop the GSE/vehicle at the safe location to the extent permitted by the situation,
 - open door for quick evacuation of persons on board the vehicles.
- If fire is discovered in a parked aircraft, cargo door should not be opened.

 ITA AIRWAYS Volume II HLM	RAMP HANDLING	8.3	Page 9
	GROUND OPERATIONS SUPERVISION AND SAFETY	Ed 2/20 apr 2022	

8.3.7.3 Emergency procedure and alerting personnel on board the aircraft

- All personnel working on the ramp shall be familiar with fire-fighting procedures.
- Any suspected or known fire shall be reported immediately.
- All staff shall be aware of location of emergency exits in the terminal building if need to evacuate the building.
- If fire is discovered on a parked aircraft, alert crew, aircraft maintenance personnel, airline representative and duty officer immediately.
- In case of fire, operator shall immediately established communication with the crew through headset or alternatively use standard hand signals. If no communication can be established and is safe to do so, the operator shall proceed to the cabin and established communication.

8.3.7.3.1 In case of fire alarm

- Stop work at once and immediately vacate the area.
- Guide passenger/visitor to the nearest exit or fire escape/Assembly point. Assist people with reduced mobility.
- Leave the building by the nearest exit or fire escape.
- Wait for the "All Clear" signal from concerned authorities.

8.3.7.3.2 In case of fire

- Immediate vacate the area. Raise the emergency alarm by activating a manual call point, which will be found on route to the fire exit.
- Proceed towards the next fire exit. Close any doors you pass through on your route to the fire exit. Do not attempt to retrieve your belongings.
- Follow instructions of fire warden and evacuate the building.
- If the area you are evacuating from or through to reach your fire exit is smoky, ensure occupants and yourself are keeping as low as possible. (remember smoke raises and clear air will be found at low level, you may need to crawl to safety).
- Should you become trapped within a room, try to block the gaps around doors, windows or penetration through walls. Clothing, (even your own), rugs and curtains will help to block this gaps. If water is available in the room, try to soak some of the material before placing in the gap.
- Try to wet a cloth and place this over your nose and mouth when caught in smoke. Breathing through this will help eliminate inhaling smoke particles.
- Inform the nearest fire warden if any persons are trapped or injured or if any other emergency exit.
- Call the Airport Emergency Service. Give the exact location and if possible, the type of fire. Speak clearly and slowly.
- Depending on the nature of fire and if safe to do so, attempt to extinguish the fire utilizing the fire extinguisher located throughout the airport without endangering self or others. Ensure your exit path is clear and away from the fire.
- Leave the building using stair case only; do not use travelators, escalators or elevator.

 Volume II HLM	RAMP HANDLING	8.3	Page 10
	GROUND OPERATIONS SUPERVISION AND SAFETY	Ed 2/20 apr 2022	

8.3.7.4 Controlling and reporting fires

- All staff shall be familiar with the local emergency telephone numbers for reporting fires.
- Any suspected or know fire must be reported immediately.
- If fire occurs on a GSE, it should be controlled using the apron extinguisher or the extinguisher on the equipment.
- Inform Supervisors, Superiors of the airline representative and/or Airport Emergency Service and seek assistance.

8.3.8 SPILLAGE

On discovery of any spillage, make sure the area is safe by containing the spill and keeping people away from spillage.

An initial assessment of the spillage, shall be made to determine whether the spillage is hazardous or non-hazardous, and whether emergency service are required. If emergency service are called, the area shall be evacuated and cordoned off until declared safe.

8.3.8.1 Non-hazardous

Where spillage has been identified as non-hazardous and the IATA regulation do not apply:

- Contact the aircraft engineer.
- Inform the Company representative.
- Arrange for the spillage to be cleaned up by the airport authority, airport fire service or service provider, as applicable.
- Personal Protective Equipment (PPE) shall be considered before attempting to clean and contain the spillage.

8.3.8.2 Hazardous

Where spillage has been identified as hazardous:

- Evacuate the contaminated area of the aircraft.
- Contact the local authority including emergency response.
- Contact the commander of the aircraft if attending the aircraft.
- Ensure the area is clear and contained.
- Contact the aircraft engineer.
- Inform the Company representative.
- Only re-enter the area once approval received for the local authority/emergency authority.
- All hazardous spillages shall be co-ordinated by appropriate authority.

8.3.9 PASSENGER SAFETY

Passenger movement on the ramp between the aircraft and the terminal building or ground transport vehicle shall always be closely supervised. Ground Staff shall ensure that passengers are led via marked, dedicated passenger walkways on the apron and kept away from the areas marked by safety marker cones so they are protected or clear from such hazards as aircraft protrusion, GSE, Fuelling Zones and Jet Blast.

 Volume II HLM	RAMP HANDLING	8.3	Page 11
	GROUND OPERATIONS SUPERVISION AND SAFETY	Ed 2/20 apr 2022	

8.3.10 SUPERVISION

Every station shall identify a staff with the responsibility to oversight all the ground operation activities in term of safety, security and quality perspective. This supervision shall monitor the adherence at the policy, processes and procedures stated in the relevant manual.

All the activities outsourced to an external entity shall be supervised as well.

The identified staff shall attend a basic and recurrent training course on supervision of the ground operation activities.

 ITA AIRWAYS Volume II HLM	RAMP HANDLING	8.4	Page 1
	GENERAL INSTRUCTIONS FOR USE OF GSE	Ed 2/20 apr 2022	

8.4 GENERAL INSTRUCTIONS FOR USE OF GSE

8.4.1 SAFETY INSTRUCTIONS FOR USE OF GSE

GSE (Ground Support Equipment): Any piece of mobile equipment, whether or not powered or self-propelled, that is purpose-designed, built and used for ground handling, servicing or field maintenance on the ramp and aircraft movement area of an airport.

Apply these procedures whenever operating any GSE on the ramp:

- Only drive or operate GSE if you are trained and authorized.
- Make sure GSE is usable and suitable with the aircraft to be handled.
- When found to be defective, is reported and evaluated for removal from service.
- Tagged as “Out of Service” and not utilized in airside operations if found in unserviceable condition and removed from operations for repair or maintenance if unserviceable.



Caution:

- If operating equipment, check the equipment contact zone for possible aircraft damage and report any damage found immediately.
- Use all safety devices fitted on GSE (e.g. bumpers, handrails, stabilizers, etc.) during aircraft handling to ensure the safety of the staff and passengers from accidental falls.

8.4.1.1 GSE maintenance

All GSE shall be maintained in accordance with instructions and/or guidance from the GSE manufacturer, in order to keep them serviceable and in good conditions to ensure the safety of operations.

Maintenance shall be documented in records, and such records are retained for period specified by the Company and local authority.

8.4.2 BASIC OPERATING REQUIREMENTS FOR GSE

- Check all GSE involved in aircraft handling at the start of a shift (at least once per day), in particular the "parking" brakes, rubber protective bumpers and all other proximity sensors.
- Perform a walk around check prior use to verify if the GSE is in good mechanical conditions.
- Apply parking brakes and place the gear selector in the park or neutral position on all GSE when are parked or positioned at or near the aircraft.
- Do not carry personnel during GSE movement.
- While driving personnel must be seated properly and should keep bodies within contour of vehicle structure.
- Do not operate vehicles or equipment while using hand-held portable electronic devices.
- GSE shall never move across the areas reserved for aircraft taxiing or passenger boarding/ disembarking.

 ITA AIRWAYS Volume II HLM	RAMP HANDLING	8.4	Page 2
	GENERAL INSTRUCTIONS FOR USE OF GSE	Ed 2 Rev 8/15 mar 24	

- Speed of GSE must comply with the limits imposed by the airport Authority.
- Cart trains tend to "drift on "(shortening turning radius) when turning corners, therefore drivers shall avoid turning prior to or immediately after passing an obstacle.
- When positioning GSE, make sure:
 - The protective rubber bumpers are not in contact with the aircraft fuselage (except for passenger boarding devices which shall not have the bumpers compressed).
 - Clearance is kept between any type of GSE and the aircraft to allow vertical movement of the aircraft during the whole ground handling process.
 - Minimize gaps between the aircraft and GSE.
 - Does not obstruct the evacuation of persons from the aircraft in emergency.
 - Unnecessarily impede the accomplishment of other aircraft handling operations in progress.
- When positioned at the aircraft, has guides and safety rails deployed in the raised position (i.e. conveyor belts, loaders, catering trucks and other elevated devices - except where restricted by aircraft type).
- The operator of an operating GSE positioned at the aircraft shall:
 - remain in a position with easy access to emergency control;
 - remain in control of GSE if it is not equipped with external emergency control;
 - extend the stabilizers or apply the chocks (if the GSE is fitted), in order to prevent accidental movement;
 - not leave the GSE unattended with the engine running, with the exception of operations carried out under conditions of low temperatures with the GSE assured with chocks.
- If fitted with stabilizers, has the stabilizers deployed.
- GSE attachment fittings, transfer bridges or platform are correctly deployed when the equipment is in position at the aircraft access door.
- Do not drive GSE with elevating equipment in the elevated position, except for final positioning of the GSE at the aircraft.
- Do not move any GSE, except ground power units (GPU) or ground power cable, including passenger boarding bridges, towards the aircraft unless all of the following criteria are met:
 - Aircraft has come to a complete stop.
 - Engines have been switched off and are spooling down.
 - Anti-collision lights are switched off.
 - Wheel chocks are positioned.
 - Ground/Flight Deck communication has been established, and clearance has been given, if applicable.
- When parked, all non-motorized GSE must have brakes set or chocks in place when not connected to motorized vehicles
- ULDs must be secured on dollies or transporters (or trailers / trucks) using the appropriate restraints (locks, stops and rails), except when the load is being transferred onto or off the equipment.
- Pallet and container dollies may only be towed with the turntables in the locked position "straight line", and rotated only at the loader rear platform.
- Operators of equipment shall ensure that other personnel are not entrapped by movement of load/pallets/containers either in the aircraft or on the loading equipment.
- Sideboards of loaded carts should be lowered carefully, in case loose cargo falls out and causes injury.

 ITA AIRWAYS Volume II HLM	RAMP HANDLING	8.4	Page 3
	GENERAL INSTRUCTIONS FOR USE OF GSE	Ed 2 Rev 8/15 mar 24	

- Holds shall only be entered/exited by the operators using the GSE (conveyor belt and loader) positioned, secured and with its moving parts stopped.
- Do not walk between ULDs or carts being towed, or when they are stationary on the ramp.
- GSE that is being towed to a position at or near the aircraft, where possible:
 - Is driven along a path that does not require sharp turns;
 - Approaches the aircraft on a path parallel to the side of the aircraft fuselage;
 - Is parked in a parallel position to the aircraft.
- Once aircraft loading operations have been completed, GSE is removed and parked outside the ERA.

8.4.3 GSE/VEHICLES SAFETY DRIVING AND PARKING INSIDE ERA

Apply the following precautions when driving or parking GSE/vehicles within the ERA:

1. Make a minimum of one complete stop with all motorized GSE/vehicles prior to entering the ERA.
2. Conduct a "Brake Check" or "Safety Stop" by coming to a full and complete stop to confirm the serviceability of the brake system on the GSE/vehicles and testing the apron surface. This action must be carried out even when there is no Equipment Restraint Line marked on the apron. This stop must be performed while approaching the aircraft at a distance no less than 5 m/15 ft from the aircraft.
3. Do not drive GSE faster than walking speed.
4. Manoeuvre GSE very carefully in order to prevent personnel injury and/or aircraft damage.
5. Every approaching/removal manoeuvre of GSE to/from the aircraft must be conducted with the assistance of a Guide Man:
 - make sure a Guide Man is in position to accurately judge clearances and communicate signals to the driver/operator.
 - stop immediately if visual contact with the Guide Man is lost.
 - a Guide Man is not required if the equipment is fitted with technology that enables the operator to accurately judge clearances and properly position it to and from the aircraft (operation is allowed only if previously authorized by appropriate department).
6. Any moving vehicle that is not positioning at the aircraft must stay outside the operational safety buffer zone.
7. Do not drive or park under the aircraft fuselage and/or wing, except for:
 - a. GSE and vehicles needed for aircraft servicing, e.g. an aircraft refuelling truck, water servicing truck, toilet servicing truck.
 - b. On stations or with aircraft types where the aircraft/stand configuration makes it necessary to tow dollies under the wing during (off)loading the aft cargo hold of a wide body aircraft. In such situations tow only empty dollies under the rearmost part of the right wing only.
8. The number of carts and dollies in a train shall be restricted to the maximum specified by local airport regulation.
9. During operations inside ERA, assure that GSE is parked:
 - a. only in designated airside equipment parking areas when not in use;
 - b. in a manner that does not obstruct access to fire fighting equipment;
 - c. in a manner that does not obstruct access to the fuel hydrant emergency stop switch.

 Volume II HLM	RAMP HANDLING	8.4	Page 4
	GENERAL INSTRUCTIONS FOR USE OF GSE	Ed 2/20 apr 2022	

8.4.4 PASSENGER BOARDING EQUIPMENT

8.4.4.1 General

1. Is allowed to position boarding devices only if the aircraft door is closed.
2. Make sure the equipment does not contact the wing root leading edge fairing that extends under certain cabin access doors.
3. Make sure any sliding rails and canopies on the equipment are fully retracted during positioning, and fully extended only once the equipment is in position. If the equipment's sliding rails cannot be extended until the door has been opened, then make sure they are extended as soon as the door has been opened.
4. If the boarding GSE is not equipped with an auto-levelling system, position the floor of the boarding device 15cm/6in below the door sill. This reduces the possibility that the aircraft door will be damaged in the event of the aircraft settling during loading and unloading operations.

 ITA AIRWAYS Volume II HLM	RAMP HANDLING	8.4	Page 5
	GENERAL INSTRUCTIONS FOR USE OF GSE	Ed 2/20 apr 2022	

8.4.4.2 Loading Bridge

- Report any malfunction of the loading bridge to the appropriate person/authority in a timely manner.
- Check that the Loading bridge is serviceable.
- The loading bridge must be fully retracted and repositioned in its dedicated area (if applicable) prior aircraft arrival and departure movement.
- Check that the walking surfaces are free from conditions that could cause injury to passengers or Ground Staff.
- A safety device must be placed across the forward opening of the passenger boarding bridge platform when the bridge is removed from the cabin access door.
- Make sure the movement path is clear of personnel, GSE and vehicles prior to movement of the loading bridge or wait for a thumb-up signal by Ground Staff.
- Only the loading bridge operator shall be on the bridgehead while it is moving.
- Move the loading bridge slowly to the aircraft cabin access door sill.
- Once reached the position, bumper shall never be compressed to the aircraft.
- Keep sufficient clearance between loading bridge and the underside of the cabin door or as directed by the cabin door markings.
- Once the boarding bridge is in position at the cabin access door, engage any safety systems and auto-levelling system. If the loading bridge is not equipped with an auto-levelling system, the bridge must be attended by an operator.
- The loading bridge must be positioned at cabin access door at all times when such door is open.
- After the cabin door is closed by an authorized person, remove immediately the loading bridge.
- If the loading bridge is fitted with devices that prevent operations by an unauthorized persons when an operator is not at the controls, the operator, before leaving the loading bridge, shall ensure such controls are secured.

 ITA AIRWAYS Volume II HLM	RAMP HANDLING	8.4	Page 6
	GENERAL INSTRUCTIONS FOR USE OF GSE	Ed 2 Rev 8/15 mar 24	

8.4.4.3 Passenger stairs

- Passenger stairs must be outside the ERA before aircraft arrival and departure.
- Check that the passenger stairs are suitable for the aircraft to handle and serviceable.
- Check that the walking surfaces are free from conditions that could cause injury to passengers or Ground Staff.
- Retract and block sliding side rails (if applicable).
- Make sure the movement path is clear before moving the passenger stairs.
- If the passenger stairs are towed you must disconnect them from the tractor and manually position them on the aircraft.
- Move the passenger stairs slowly towards the aircraft.
- once reached the position, bumper shall never be compressed to the aircraft.
- Keep sufficient clearance between passenger stairs and the underside of the cabin door, or as directed by the cabin door markings (if installed).
- Engage any safety systems and auto-levelling system, if applicable. If the passenger stair is not equipped with an auto-levelling system, the level of the passenger stair must be monitored and, if required, adjusted.
- Deploy stabilizers (if applicable). Do not allow anyone (except the operator) to use the stairs until the stabilizers are deployed.
- Extend and block sliding side rails after the cabin door has been opened (if applicable).
- Make sure passenger stairs are positioned such that the cabin door can be used as an unobstructed escape route in the event of an emergency.
- Immediately before closing the cabin door, retract and block sliding side rails (if applicable).
- Close the cabin door before removing the passenger stairs.
- After the cabin door has been closed, confirm there is no staff on the stairs prior to retracting stabilizers (if applicable).
- If the stairs are not positioned on the aircraft then they must be pulled back sufficiently to allow the deployment of slides in case of emergency.
- If passenger stairs are towed when removed from the aircraft, manually position them clear of the aircraft to a suitable position before connecting them to the tractor.

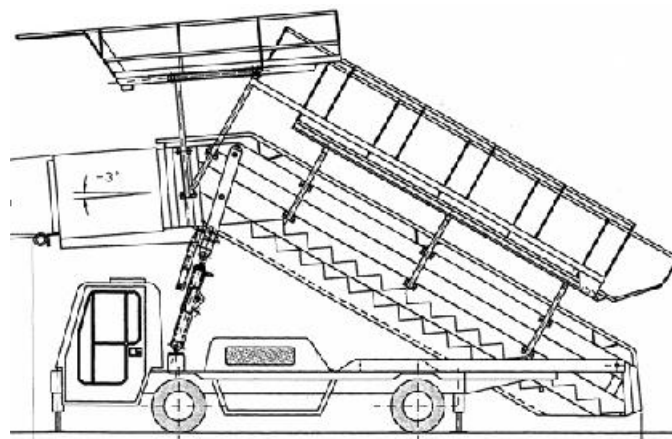

 ITA AIRWAYS Volume II HLM	RAMP HANDLING	8.4	Page 7
	GENERAL INSTRUCTIONS FOR USE OF GSE	Ed 2 Rev 8/15 mar 24	

8.4.5 GROUND POWER UNIT (GPU)

It is permitted to pre-position a GPU inside the ERA provided there is a special assigned GPU parking position. If such position is not available, positioning of the GPU is only allowed after arrival of the aircraft:

- position the GPU on the side where aircraft external power plug is located (usually the right) with the towbar facing away from the aircraft as (shown below).
- non motorized GPU shall be disconnected from the tractor after being positioned.
- set parking brake / chock the GPU (if required).

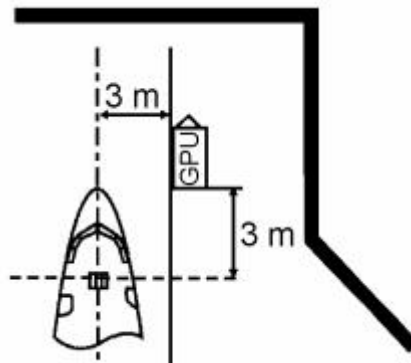

Note:

Do not place the GPU too close to the aircraft, especially when the exhaust pipe is fitted at the top, so as to avoid coating distortion due to high temperature.

Connecting the GPU

- Only after chocks have been positioned on the nose landing gear.
- In case of a short turnaround the GPU remains connected to the aircraft.
- In case of a long turnaround or maintenance delivery, the GPU must be connected and started at the beginning of the cockpit crew pre-flight check.

Disconnecting the GPU

- Disconnecting the external power cable from the aircraft must be done after approval of the cockpit crew.
- Prior to disconnecting the external power cable, make sure that the "EXT POWER NOT IN USE" light on the aircraft external power panel is on.



Caution:

- Inspect cords and connector for signs of excessive wear.
- Do not connect the external power receptacle when a "Do not use" or "Do not operate" danger placard is attached to the external power panel or receptacle.
- Make sure the power switch of the unit is switched off, before disconnecting the external power connector.
- Make sure that the GPU is parked in such a way that the exhaust pipe is directed opposite from the aircraft fuselage.

 Volume II HLM	RAMP HANDLING	8.4	Page 8
	GENERAL INSTRUCTIONS FOR USE OF GSE	Ed 2/20 apr 2022	



Caution:

In case it will be necessary move the GPU during ground operations, while it is impossible to stop electric supply, maneuver shall be performed entirely with the assistance of a guide-man which supervises the wire tension in order to avoid heavy damages to aircraft.

 ITA AIRWAYS Volume II HLM	RAMP HANDLING	8.4	Page 9
	GENERAL INSTRUCTIONS FOR USE OF GSE	Ed 2 Rev 2/26 jan 23	

8.4.6 AIR STARTER UNIT (ASU)

If the Auxiliary Power Unit (APU) is unserviceable, an Air Start Unit (ASU) must be used for engine starting. Depending on the specific ASU performance and on the aircraft technical characteristics, additional ASU may be necessary. The ASU must be positioned on the ramp as shown in the photo below. Unless different instructions by the Captain, such positioning is valid for all ITA fleet aircraft.

Operation

To prevent damage to the aircraft and personal injury, ensure that the ASU is positioned in such a way, that:

- It will not hamper other ramp operations, such as loading and fuelling.
- It is parked outside the engine hazard areas (if possible).
- It is parked at least 2 metres from the aircraft.
- The towbar is directed away from the aircraft and coupled to the tractor to simplify its removal after engine start-up. (Towed ASU only.)
- It could be easily removed after engine start-up, avoiding the engine hazard areas.
- The exhaust pipe of the unit is directed away from the aircraft fuselage and wing.



Caution:
 If the ASU shall be positioned within an engine hazard area, ensure that the applicable engine will be started only after disconnecting/removal of the ASU.

Before Engine Start-Up

When connecting to the aircraft, make sure the air supply hose touches the ground and avoid small-radius elbows.

Ensure that the air supply hose coupling is firmly attached to the aircraft connector, and pressurise the ASU only after consent has been achieved from Flight Deck via the responsible for departure.

After Engine Start-Up

Once the engine has started, and after approval from the cockpit crew, shut off the air supply and disconnect the air hose from the aircraft. To expedite the departure of the flight remove the ASU immediately, avoiding entering the engine hazard area.

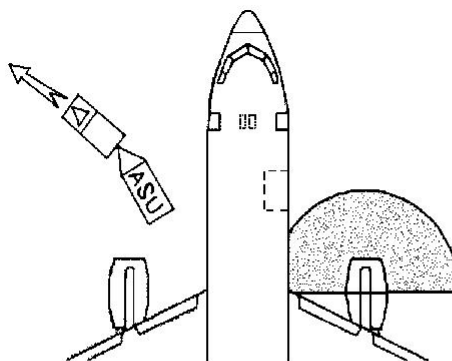

 Volume II HLM	RAMP HANDLING	8.4	Page 10
	GENERAL INSTRUCTIONS FOR USE OF GSE	Ed 2/20 apr 2022	

8.4.7 COOLING / HEATING UNITS PRE CONDITIONED AIR (ACU)

To connect ACU:

1. Open access panel.
2. Connect ground air pre-conditioning unit to aircraft.
3. Start up ground air pre-conditioning unit.
4. On ground air pre-conditioning unit, select the desired cooling or heating air temperature or appropriate selector position.
5. Non motorized ACU shall be disconnected from the tractor after being positioned

To disconnect ACU:

1. Shut down ground air pre-conditioning unit.
2. Disconnect ground air pre-conditioning unit from aircraft.
3. Close access panel.
4. Retract PCA hose to fully stowed and secured position.



Caution:

Before supplying air by external source make sure that at least one cabin door is open and remains open during air unit operation.

Make sure that a motorized air ground supply unit is not near the aircraft. The engine exhaust pipe of the unit **MUST** point away from the aircraft. Heat from the unit's exhaust can cause damage to the aircraft structure.

 Volume II HLM	RAMP HANDLING	8.4	Page 11
	GENERAL INSTRUCTIONS FOR USE OF GSE	Ed 2/20 apr 2022	

8.4.8 FILLING POTABLE WATER

8.4.8.1 Introduction

It is the responsibility of suppliers to ensure that all potable water loaded onto aircraft is compliant with WHO (World Health Organisation), local standards or Companies requirements, whichever are higher and in which chemical substances and microorganism limits are not harmful to passengers and crew. Is therefore essential that all suppliers adhere to sanitary requirements.

For operations of aircraft access panels or doors and servicing controls refer to related Company's technical instructions (see Chap. 5.x.x for ITA).

For ITA A320, A330 and A350 the water quantity to be loaded shall be reduced. If for technical reasons is not possible to apply the procedure, refill completely the tank/s (FULL) and inform the Load Controller in order to adjust the DOW/DOI value.

8.4.8.2 General rules

1. Before opening the service panel perform a visual check of aircraft fuselage and check for stains or leakage around the panel, in case inform immediately the Company representative.
2. At the end of operation, verify that no leakage is present, in case inform immediately the Company representative.
3. Close and latch the service panel.

8.4.8.3 Hygienic precaution

- a. The cleaning and disinfecting of servicing vehicles must be performed weekly.
- b. The interior of water tank/s shall be scoured, clean and disinfect monthly, in order to remove any deposit.
- c. Potable Water Service Units and Toilette Service Units must not be parked in the same area.
- d. Potable Water Service Units must not be filled up from the same tap as Toilette Service Units.
- e. The filling hose connector must be of a size as recommended by ISO 450 (Aircraft-Connection for Water of Drinkable Quality). When the filling hoses are not in use, the nozzles or connectors must be protected from contamination either by the use of appropriate covers or by immersing them in receptacles containing chlorinated water.
- f. Personnel must wear clean clothing and thoroughly wash hands, with soap, before starting water servicing.
- g. To ensure the integrity of potable water supply chain, toilette service and water potable service must be performed by two different operators during the same shift.
- h. The potable water supply service to the aircraft shall be carried out before the toilet drain service.

 Volume II HLM	RAMP HANDLING	8.4	Page 12
	GENERAL INSTRUCTIONS FOR USE OF GSE	Ed 2/20 apr 2022	

8.4.8.4 Water disinfection

Water destined for aircraft water systems must be potable. If required, only products approved by local health authority and Company shall be used to sanitise potable water.

If Chlorine is used, content at point of filling into the aircraft must be in the range of 0.3-0.5 mg/l. The Potable Service Unit may only be used after 30 minutes, in order to allow chlorination agent time to react.

8.4.8.5 Water analysis

Periodic water analysis must be performed by Ground Service Provider no less than **four times (4) per year** at:

1. **Airport water source** (only if the water is supplied directly from the source to the aircraft)
2. **Outlet of the tank vehicle**

Results of the analysis must be filed at the station for **two (2) years** and kept available upon airline request. Bacteriological contamination of the water must not exceed the standards established by WHO or those issued by local authority, if these are more stringent.

 ITA AIRWAYS Volume II HLM	RAMP HANDLING	8.4	Page 13
	GENERAL INSTRUCTIONS FOR USE OF GSE	Ed 2/20 apr 2022	

8.4.9 TOILETTE DRAIN

8.4.9.1 Introduction

General Toilette Service includes the following: emptying, flushing and replenishing of fluids in aircraft tanks.

The chemical precharge used for flushing and filling the lavatory tank is corrosive. Blue Ice is created when restroom holding tanks or drain tubes on aircraft leak. During the approach to land, the formed ice may drop off the aircraft, posing hazard to ground personnel and the aircraft itself.

The non-observance of the servicing procedures described below, may result in aircraft damage or other inconveniences such as: inoperative toilettes during the flight, delay and cancellation.

For operations of aircraft access panels or doors and servicing controls refer to related Company's technical instructions (see Chap. 5.x.x for ITA).

8.4.9.2 General Rules

1. Before opening the service panel perform a visual check of aircraft fuselage and check for stains or leakage around the panel (blue ice), in case inform immediately the Company representative.
2. During draining and replenishing of fluids in aircraft tanks maintain safe distance.
3. At the end of operation, verify that no leakage is present, in case inform immediately the Company representative.
4. Close and latch the service panel.

8.4.9.3 Hygienic Precaution

- a. Potable Water Service Units and Toilette Service Units must not be parked in the same area.
- b. To ensure the integrity of potable water supply chain, toilette service and water potable service must be performed by two different operators during the same shift.
- c. Potable Water Service Units must not be filled up from the same tap as Toilette Service Units.

8.4.9.4 Servicing in extreme cold weather conditions

If the aircraft is parked in the open for several hours without heat (aircraft power) and the temperature is (or is expected to be) below freezing point, the following precaution must be taken:

- a. Drain the aircraft waste tank on arrival.
- b. Fill the aircraft toilette system only after the aircraft cabin is warm and as close to the flight departure time as possible.
- c. Ensure the fill line is fully drained before closing the cap to prevent freezing of fluid in the fill line.

 ITA AIRWAYS Volume II HLM	RAMP HANDLING	8.4	Page 14
	GENERAL INSTRUCTIONS FOR USE OF GSE	Ed 2/20 apr 2022	

8.4.10 AIRCRAFT LOADING EQUIPMENT

8.4.10.1 Belt loader

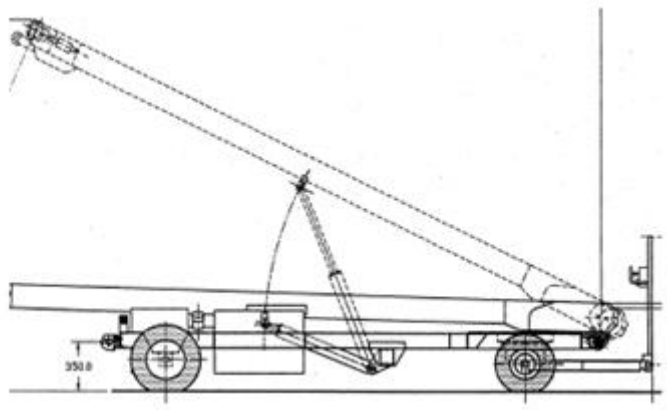

The following precautions must be taken when operating a belt loader:

- Check that the belt loader is suitable for that aircraft to handle and serviceable.
- The boom of the belt loader must never be positioned inside the cargo hold of any aircraft.
- Always position and remove a belt loader in a straight line with the compartment door at a 90 degree angle to the aircraft fuselage.
- Ensure the boom is clear of the aircraft or other obstacles before making a turn.
- The rubber bumpers on a conveyor belt loader must NEVER make contact with the aircraft. The minimum distance to be maintained at all times is 2.5/1" cm from the fuselage.
- Maintain proper separation between articles on the conveyor belt to avoid jamming.
- Adjust the back of the conveyor belt; avoiding dropping goods on the belt and for the safety of the employees while loading /offloading.
- Handrails shall be deployed when a belt loader is used to gain access to aircraft cargo holds; however caution shall be exercised when using the belt loader handrail on certain aircraft with engines positioned at the tail in proximity of the cargo door. In this particular case the handrail shall be lowered avoiding contact with the underside of the engine.
-

Note:

Specially designed belt loaders e.g. Ramp Snake or Powerstow are allowed to be positioned inside the cargo hold.



 Volume II HLM	RAMP HANDLING	8.4	Page 16
	GENERAL INSTRUCTIONS FOR USE OF GSE	Ed 2/20 apr 2022	

8.4.10.2 Loader (ULD)

- Check that the loader is suitable for the aircraft to handle and serviceable.
- Check that the walking and loading surfaces are safe for use.
- Lower both platforms during manoeuvring of a loader.
- Make sure the movement path is clear before moving the loader.
- Never drive a loader underneath the wing of an aircraft.
- Move the loader slowly towards the aircraft, avoiding any aircraft sensors or wing canoe fairings.
- Approach aircraft cargo door in a straight line.
- Loaders must never make any contact with the aircraft. Position loader no closer than 5cm/ 2" or until the proximity sensors stop the movement (if equipped).
- Do not open/close aircraft cargo compartment doors while standing on a loader, use either technical steps, or a belt loader with a raised side safety rail. (Not applicable to main deck cargo doors.)
- Engage any safety systems and auto-leveler features if applicable. If the loader is not equipped with an auto leveler, the level of the loader must be monitored and adjusted as required.
- Deploy stabilizers if fitted and raise safety rails.
- Constantly monitor the parts of the aircraft which could come into contact with the loader (e.g. edge of cargo hold opening, aircraft cargo door, control panel doors, fairings on fuselage and wings).
- Adjust the loader's front platform during loading as required when aircraft's level varies as the load changes.
- Do not pull loads on or off roller equipment. Push loads in the direction of travel.
- Do not stand between loader and moving dollies.
- Use signal guide man to align dollies to loader.
- No persons, other than qualified ground handling personnel must be present inside the cargo compartment. Personnel must stay clear of moving ULDs. Injury can result from impact with ULDs and from being caught between ULDs or cargo compartment wall.
- Do not operate PDUs until personnel working in the cargo hold is clear of all hazards (i.e. locks, ULDs and PDUs).
- If assisting the loader operator, do not operate the PDUs until you know where the operator is as the loader operator may be inside the cargo hold.
- Whenever possible, reverse in a straight line at a walking speed, monitoring all sides for clearance.
- it is forbidden to rotate a ULD on a loader platform while the loader platform is raised or in-transit. The ULD loader platform must be fully lowered before a ULD is rotated for loading/offloading.

 Volume II HLM	RAMP HANDLING	8.4	Page 17
	GENERAL INSTRUCTIONS FOR USE OF GSE	Ed 2/20 apr 2022	

8.4.10.3 Transloader

- Check that the transloader is suitable for the aircraft to handle and serviceable.
- Check that the transloader is serviceable.
- Check that the walking and loading surfaces are safe for use.
- Lower platform during manoeuvring of the transloader
- Make sure the movement path is clear before moving the transloader.
- Move the transloader slowly towards the aircraft, avoiding any aircraft sensors or wing canoe fairings.
- Transloader must NEVER make any contact with the aircraft. Position transloader no closer than 5cm/2" or until the proximity sensors stop the movement (if equipped).
- Adjust the level of the transloader if required.
- Constantly monitor the parts of the aircraft which could come into contact with the transloader (e.g. edge of cargo hold opening, aircraft cargo door, control panel doors, fairings on fuselage and wings).
- Adjust the transloader front platform during loading as required when aircraft's level varies as the load changes.



Caution:

Once ULDs are loaded on transloader the operator view is restricted; pay attention at other people working on ramp as serious injury may occur.

8.4.10.4 Fork-lift to slave pallet

When a highloader is not available a forklift in combination with a "slave" pallet can be used to load or unload pallets and containers. A slave pallet is a frame suitable for lifting, equipped with forklift tine attachments and with rollers with the relative locks on its top-surface. The forklift with the slave pallet attached is used in the normal way.

The rollers assist in the loading of the container or pallet onto the slave pallet and in its transfer to the aircraft but are not powered. The locks must be engaged during all lifting and manoeuvring operations to ensure safety of equipment and personnel.

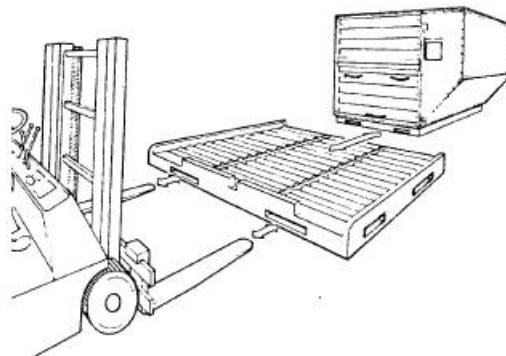

 ITA AIRWAYS Volume II HLM	RAMP HANDLING	8.4	Page 18
	GENERAL INSTRUCTIONS FOR USE OF GSE	Ed 2 Rev 13/28 mar 25	

8.4.10.5 Transporter

Depending on transporter design, there are three different ways of loading:

Type 1- One way Loading



Type 2- Two way Loading

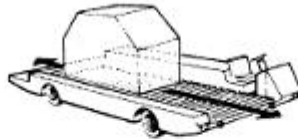

Type 3- Three way Loading



The platform is adjustable to dolly, conveyor or loader height and powered rollers assist in loading and unloading from front and rear end.

- Do not use Transporter in stands where there's no sufficient clearance to manoeuvre it safely.
- The train of pallet and dollies shall be parked at distance from the aircraft in order to consent self-propelled Transporter to cover the distance between dollies and the high loader.
- When using a transporter Type 2 is preferred to approach the loader in backward direction (when the transporter is empty) and keep ULDs from the rear.

8.4.10.6 Rolling stock (carts / dollies)

- Do not wedge light packages between heavier items.
- Ensure sides on carts are up while transiting, (if equipped).
- Ensure the overall weight of load permits safe manual manoeuvring of carts.
- Do not overload and ensure that the securing equipment is used, sides up, webbing closed etc.
- Ensure the overall height of load permits safe lifting of each piece of load during loading and offloading of carts by personnel standing on the ground.
- All doors and panels must be in the upright and locked position at all times while cart is in tow.
- When using tarpaulins, ensure all straps are securely fastened to the baggage cart.
- Approach the aircraft at walking speed to prevent jackknifing.
- When not in use the braking system shall be engaged on all strings of baggage carts.
- Do not use carts to gain access to cargo compartments.

8.4.10.7 Tractors

- Drive tractors and carts at a slow, regular speed, and take care to avoid sharp turns, jerks and sudden stops.

 ITA AIRWAYS Volume II HLM	RAMP HANDLING	8.5	Page 1
	DOORS OPENING/CLOSING (ALL AIRCRAFT TYPES)	Ed 2/20 apr 2022	

8.5 DOORS OPENING/CLOSING (ALL AIRCRAFT TYPES)

8.5.1 GENERAL

Ground Staff is not allowed to open the aircraft doors from the inside.
 Operation is allowed only if previously authorized by the appropriate department.

Ground Staff can perform aircraft door operations only if trained and authorized for such figure, in accordance with the technical specifications of the aircraft manufacturer and/or the procedures as outlined by the Company.

Cabin door can be opened/closed only if a GSE (or loading bridge) is positioned at the door, because there is a risk of falling during handling. This provision also applies to cabin doors left opened for an extended period of time. The safety strap installed on the door doesn't represent an alternative to using the GSE.

Seek for assistance from maintenance personnel if any difficulty is experienced during normal doors operation.

In case of failure of the electric or hydraulic door opening, only maintenance personnel or flight crew can operate manually.



Caution:
 Do not operate or leave doors open during strong winds condition as indicated in paragraph 8.3.6.3.1 "High winds activity matrix".

Any damage discovered during the inspection of doors and surrounding areas/frames shall be immediately reported to Maintenance personnel and/or a Company representative.

8.5.2 CABIN AIRCRAFT DOORS

If an aircraft not involved in ground assistance is discovered with a door opened and no GSE positioned:

1. Immediately notify your supervisor or the Company representative.
2. Do not attempt to close the cabin door.
3. Guard door until a qualified person comes to close the door.



Caution:

- Slide deployment can be fatal. If an armed door begins to open, do not attempt to hold the door, as you risk to be seriously injured or killed by such behaviour.
- If the door cannot be opened/closed with a GSE positioned, operation shall be performed carefully from the inside. During the operation a crew member or a second Ground Operator shall check the door area inside the cabin.

 Volume II HLM	RAMP HANDLING	8.5	Page 2
	DOORS OPENING/CLOSING (ALL AIRCRAFT TYPES)	Ed 2/20 apr 2022	

8.5.2.1 Door opening with crew on board

Ground staff shall:

1. Ensure that the embarking/disembarking GSE is correctly positioned.
2. Check that there are no obstacles in the door movement area and eventually remove them.
3. Knock two times on the door from the outside to indicate that the GSE for embarking/disembarking is positioned close to the door.
4. Stay away from the door operation area and wait for the crew that will open the door.
5. Help crew during opening operation till the door stop point (if necessary).



Caution:

Before allowing passengers or crew embarking or disembarking via a boarding door, ensure that the boarding device is properly positioned at a door, and, if stairs are used, that both hand rails and extension are extended (if applicable).



Caution:

The catering operator, after knocking, shall apply the procedure described in paragraph 8.5.2.4 "Door opening from the outside without flight crew on board" in case the crew has not given an answer.

8.5.2.2 Door closing with crew on board

Ground Staff shall:

1. Ensure that the doors are closed immediately after handling is completed.
2. Receive confirmation that the door can be closed by crew.
3. Check that there are no obstacles in the door movement area and eventually remove them.



Caution:

If the last accessible door for disembarking is going to be closed, advise Ground Personnel eventually still on board.

4. Ensure that the door gust lock is released and help the crew member that is closing the door bringing it to ajar position.
5. Before leaving the door area, ensure that the door is correctly seated flush with the airframe and the external door handle is flush with the door surface.
6. Seek for assistance from Maintenance personnel if any difficulty is experienced during normal doors operation.
7. Remove the GSE from a cabin access door immediately after such door is closed.
8. If are used stairs for embarking, before closing the door remove the stair hand rails and the extension (if applicable). Stay on top of the stairs till the door is completely closed and get off the stair before it is removed.
9. Check that the manoeuvring area of the GSE is free from obstacles and there is no personnel before removing it from the aircraft.
10. Ensure that there are no damages on the door and its frame.

 Volume II HLM	RAMP HANDLING	8.5	Page 3
	DOORS OPENING/CLOSING (ALL AIRCRAFT TYPES)	Ed 2/20 apr 2022	

8.5.2.3 Door re-opening with crew on board

In case all doors are closed and it a re-opening is necessary, from both flight crew or Ground Staff, follow the procedure described below:

1. Ground Staff is not allowed to open the door without Captain's specific authorization.
2. In order to achieve such authorization establish a earphone connection (or use manual signals) with Flight Deck.
3. Regardless who is asking for door re-opening (crew or Ground Staff) if the Captain confirms and orders the re-opening, follow the procedures described in paragraph 8.5.2.1 "Door opening with crew on board".

Note: If there is no crew on board the aircraft, then follow the applicable procedures in paragraph 8.5.2.4 "Door opening from the outside without flight crew on board".

8.5.2.4 Door opening from the outside without flight crew on board

Ground Personnel shall:

1. Ensure that the embarking/disembarking GSE is correctly positioned.
2. Check that there are no obstacles in the door movement area and eventually remove them.
3. Check that the emergency lights indicate slide disarmed and that it is safe to open the door.



Caution:

In case it is not possible to verify that the door is disarmed, do not proceed with the opening operation.

3. Once made sure that the door is disarmed, proceed with the opening slowly and carefully following the instructions shown on the door.
4. Move the door till it is completely opened till the gust lock is armed.

8.5.2.5 Door closing without crew on board

Ground Personnel shall:

1. Proceed closing the door immediately after the handling has finished.
2. Check that there are no obstacles in the door movement area and eventually remove them.



Caution:

If the last accessible door for disembarking is going to be closed, advise Ground Personnel eventually still on board.

3. Ensure that the gust lock is released, then close the door. Before leaving the door area, ensure that the door is correctly seated flush with the airframe and the external door handle is flush with the door surface.
4. Seek for assistance from Maintenance personnel if any difficulty is experienced during normal doors operation.

 Volume II HLM	RAMP HANDLING	8.5	Page 4
	DOORS OPENING/CLOSING (ALL AIRCRAFT TYPES)	Ed 2/20 apr 2022	

5. Remove the GSE from a cabin access door immediately after such door is closed.
6. If are used stairs for embarking, before closing the door remove the stair hand rails and the extension (if applicable). Stay on top of the stairs till the door is completely closed and get off the stair before it is removed.
7. Check that the manoeuvring area of the GSE is free from obstacles and there is no personnel before removing it from the aircraft.
8. Ensure that there are no damages on the door and its frame.

8.5.3 CARGO AIRCRAFT DOORS

8.5.3.1 Cargo door opening

Ground Personnel shall:

1. Wait for the engine and anticollision lights turning off.
2. Check that there are no damages on the doors and on the close areas before positioning the GSE for loading/unloading or any other support equipment.
3. Open the doors using, where necessary, technical stairs or belt loaders with the hand rails uplifted. Loader or ULD transloader cannot be used.
4. In case a GSE is used to open the door, ensure that there is enough space for the operation in order to avoid damages.
5. Open the hold doors following the aircraft specifics.



Caution:

Whenever the cargo door open/locked indicator lights of A320 Family aircraft, are attesting that cargo doors are opened and locked, are inoperative, the Ground Staff shall:

- Visually check that the affected door is in the fully open position, with no downward movement after releasing the lever of the manual selector valve.
- Visually check that the lever of the manual selector valve stays in the neutral position (towards the ground).

6. In case the door doesn't open, contact Maintenance for assistance. Never force the opening (even by using tools and equipment).

8.5.3.2 Cargo doors closing

Ground Personnel shall:

1. Correctly install the separating and door protection nets.
2. Turn off the hold lights unless there is an AVI loaded in bulk.
3. Check that the door area, the sill and the frame are free of gravel, water, ice, or any other material that could prevent the door closing.

 ITA AIRWAYS Volume II HLM	RAMP HANDLING	8.5	Page 5
	DOORS OPENING/CLOSING (ALL AIRCRAFT TYPES)	Ed 2/20 apr 2022	

4. Check that the door structure has no damages.
5. Close the doors using, if necessary, technical stairs or belt loaders with the hand rails uplifted. Loader or ULD transloader cannot be used (not applicable for main deck doors of Cargo aircraft)
6. In case a GSE is used to close the door, ensure that there is enough space for the operation in order to avoid damages.
7. Close the hold doors following the aircraft specifics
8. In case the door doesn't close, contact Maintenance for assistance. Never force the closing (even by using tools and equipment)..



Caution:

If the door must be re-opened before flight departure, Captain's authorization is necessary.

 Volume II HLM	RAMP HANDLING	8.6	Page 1
	REFUELLING	Ed 2/20 apr 2022	

8.6 REFUELLING

8.6.1 GENERAL INFORMATION

Refuelling operations must always be carried out:

- by the "Fueling Handler" under the Company's responsibility;
- in presence of the "Fueling Supervisor". The Company has designated the Captain for this function. In case of refueling on wide body aircraft, as refueling supervisor, the Company may designate a qualified representative of a maintenance company, with which the same has a service contract.
- under the supervision of qualified Company representative or by maintenance or handling company personnel with whom the Company subscribed a service contract.

The Refuelling Supervisor is responsible for observing the correct technical and safety procedures during the refuelling operation. He/she shall:

- coordinate the operation with the Fuel Handler's representative on duty and with personnel possibly on-board (i.e. crew, cleaning/catering service providers, etc.);
- remain in the vicinity of or on-board the aircraft whilst refuelling is in progress. and is to ensure that all safety provisions immediately prior to and during refuelling are observed.

The representative of the handling or maintenance company, with which the Company has a service contract, in guaranteeing the supervision of the refueling operations, shall ensure the application of all the Safety recommendations, reported in this chapter, during aircraft assistance activities.

Refuelling procedures also apply to defuelling operations.

Between Company regulations and those issued by the local Aerodrome Authorities, the most stringent ones must be adhered to.

For technical procedures of into plane refuelling the Refuelling Providers shall follow the procedures described in the Company Refuelling Manual.

Note:

Refuelling with wide cut fuel (designated JET B, JP-4 or AVTAG) is not allowed.

 Volume II HLM	RAMP HANDLING	8.6	Page 3
	REFUELLING	Ed 2/20 apr 2022	

Within the Refuelling Safety Zone you must ensure that you:

- Do not smoke.
- Do not use ANY hand held portable electronic devices, including the use of an earpiece or headset. These devices include cell phones, portable music players and portable game units.
- Only use Company issued and approved Radios, radio telephones, pagers, torches, lamps and lighting systems. Battery chargers must not be operated.
- Enter the FSZ only when required by your present job task responsibility.
- Assume that refuelling servicing is taking place anytime fuel hoses are connected to the aircraft.
- The engines of unattended GSE shall be switched off.
- Position all GSE and vehicles such that they do not prevent or obstruct the movement of a refuelling vehicles away from the aircraft.
- Do not allow any passengers to enter the FSZ.
- Avoid the use of motorized GSE within the FSZ.
- Do not park any equipment in the FSZ.
- Ensure fuel hoses are protected and all ground equipment is maintained a minimum of 1 meter from any fuel hose.

Note:

Within Italian territory, the refuelling area must be provided with one or two mobile fire extinguishers in perfect working condition able to provide a total of 50 kg of dry chemical powder (extinguisher capacity not less to A-B1-C) and 50 litres of halogenated hydrocarbon foam (extinguisher capacity not less to A-B4), determined in accordance with ICAO criteria. The use of such extinguishers, for first immediate actions, is committed only to trained personnel operating in the refuelling area.

 Volume II HLM	RAMP HANDLING	8.6	Page 4
	REFUELLING	Ed 2/20 apr 2022	

8.6.3 FUELLING / DEFUELLING WITH PASSENGERS ON BOARD, EMBARKING OR DISEMBARKING

Such operations may be carried out provided local Airport Authority's approval has been granted and relevant instructions accordingly provided.

Operations shall commence in presence of Refuelling Supervisor (Captain) only after having received Airport Authority authorization.

Passengers shall be previously informed and boarding conducted in a way not to interfere with refuelling operation and ground servicing.

Refuelling with wide cut fuel (designated JET B, JP-4 or AVTAG) is not allowed.

Prior commencing Refuelling operation an inter-phone communication between Ground/Maintenance staff and Flight Deck shall be established. The handling company or maintenance representative, with which the Company has a service contract, in order to guarantee operation supervision, shall:

1. Warn Ground Staff of ongoing operations.
2. Be properly positioned so as to observe passengers disembarking/embarking.
3. Inform the Flight Deck when refuelling is going to commence.
4. Coordinate with Flight Deck any emergency according to Chap. 8.6.5 EMERGENCY DURING FUELING / DEFUELING.
5. Inform the Flight Deck when refuelling is completed.

Whenever is not possible to establish an inter-phone communication, refuelling may take place if a visual contact between Flight Deck and the handling or maintenance representative, with which the Company has a service contract and which carries out the supervision activity, is maintained during refuelling.

8.6.3.1 Duties of Station Manager

The Station Manager or his/her delegate, must inform the applicable Airport Authority and the Refuelling Supervisor that refuelling operations will be carried out with passengers on-board.

The Station Manager must:

- Ensure that local regulations are complied with where they are:
 - more stringent than those of the Company,
 - not included among those of the Company,
- Brief the Captain on any specific regulation which directly involves the crew.
- Warn passengers that refuelling is/will take place, emphasizing that use of mobile phones is not allowed.

Note:

Whenever a Manager is not designated by the Company for a specific Station (e.g. charter flights), the above mentioned duties shall be accomplished by the Handler's Station Manager (or his/her delegate).

 Volume II HLM	RAMP HANDLING	8.6	Page 5
	REFUELLING	Ed 2/20 apr 2022	

8.6.3.2 Duties of Ground Staff

The Ground Staff (i.e. Ramp Agent) which conducts supervision activity, shall:

- Verify and report to the Captain that Company provisions and local regulations are complied with.
- Warn Ground Personnel of ongoing operations.
- Inform passengers that boarding will be take place during Refuelling and lighters, smoking and mobile telephones are not allowed.
- Inform Flight Deck if any DGR shipment is on board and/or is going to be loaded in the aircraft.
- Ensure that stairs and/or loading bridges are correctly positioned at the doors in use and that the ground area under the exits where there are no stairs to use in the event of an emergency evacuation and the slide opening areas, are clear of obstacles and FOD.
- Guide Passengers during embarking/disembarking so as to avoid their interfering with refuelling or with other ground operations.
- Ensure that the area below the designated doors for emergency evacuation and slides deployment, where stairs and/or loading bridges are available and are kept free from GSE and/or obstacles.



Caution:

In the case of PRM boarding/disembarkation or catering arrangement/disassembly, for doors usage, arrangements shall be made in advance with the captain.

Note:

Within Italian territory, according to the current law (DM 169 date 22/7/2011), if refuelling operations takes place on the left side of the aircraft (left wing) passengers boarding/disembarking may take place only through a loading bridge directly connected to the terminal.

 ITA AIRWAYS Volume II HLM	RAMP HANDLING	8.6	Page 6
	REFUELLING	Ed 2 Rev 15/07 aug 25	

8.6.4 NO TRANSIT CHECK - GROUND STAFF ACTIVITIES

The Ground Staff (usually the Ramp Agent), which conducts supervision activities, shall:

1. Notify to the Fuel Provider representative the required amount of fuel and deliver to him/her a copy of the OFP page (for FCO station the Fuel Order Document issued by DCS ALTEA FM) signed by the Captain indicating the Block Fuel quantity (Kg).
2. Verify, before refuelling operation take place, that the fuel gauge is set to ZERO; if not, ask the Fuel Provider representative to reset it.
3. After refuelling is completed:
 - a. require the Fuel Provider representative the Fuel Delivery Receipt.
 - b. verify that the fuel quantity (Kg), including density and temperature data, is reported on the Fuel Delivery Receipt in a legible way and matches with the quantity registered on the fuel gauge (LT or USG).
If a mismatch is noticed, require the Fuel Provider to correct and sign the Fuel Delivery Receipt.
 - c. check that the box related to fuel quantity control check has been ticked off and signed by Fuel Provider representative (if applicable).
 - d. check, together with the Fuel Provider representative, that the fuel quantity on aircraft fuel panel matches with the required quantity; in case the fuel quantity is equal to or greater than 100 kg to the required quantity, the discrepancy shall be written on the Fuel Delivery Receipt.
4. Sign the fuel receipt as proof of the provided service and keep a copy for future preservation.
5. Deliver the Fuel Delivery Receipt to the Captain

 Volume II HLM	RAMP HANDLING	8.6	Page 7
	REFUELLING	Ed 2/20 apr 2022	

8.6.4.1 Fuel panel selection

The Fuel Provider, trained and qualified by the Company, is responsible to select the required fuel quantity on the fuel panel.

If the Fuel Provider is not qualified for the panel fuel selection, the Captain (or his delegate) or Maintenance Technician shall provide the selection on the fuel panel.

Note:

If the Fuel Provider is not qualified for the panel fuel selection, the station, by the handling personnel, shall notify to the Captain who (Captain himself or Maintenance Technician) will perform such activity.

8.6.4.2 Fuel quality control check

The fuel quality control check is accomplished by the Fuel Provider representative as follows:

- for the hydrant dispenser:
 - every refuelling.
- for the fuel truck:
 - the first refuelling of the day,
 - the first refuelling after the fuel truck leaves the depot,
 - the first refuelling after the loading or topping-up of fuel,
 - the first refuelling following exposure to heavy rain or snowfall,
 - during an inspection.

 ITA AIRWAYS Volume II HLM	RAMP HANDLING	8.6	Page 8
	REFUELLING	Ed 2/20 apr 2022	

8.6.5 EMERGENCY DURING FUELING / DEFUELING

Emergency situations during refuelling/defuelling may vary, the procedures described below cannot take into account every possible situation, therefore Ground Staff, Fuel Handler personnel and Flight Deck must keep a strict coordination to consider any local peculiar situation or circumstance of any emergency or danger.

8.6.5.1 Fuel vapours/fire detected inside the aircraft

Should fuel vapours be smelt inside the aircraft, the personnel on duty on board (i.e. cleaning, catering) shall:

1. Evacuate immediately through normal aircraft exits.
2. Inform immediately the Refuelling Supervisor.

The refuelling Supervisor shall:

- Suspend immediately refuelling operation.
- Coordinate aircraft evacuation
- Activate the emergency as per local regulation (if necessary).
- Inform a Company representative.

Note:

If this situation take place during refuelling with passengers on board the Captain will take the appropriate action.

8.6.5.2 Fuel spillage

A significant fuel spillage is considered when the amount of fuel been spilled is about 2 meters wide. In case of fuel spillage the Ground staff shall:

- Advise the fueling handler.
- Alert Flight Crew and the Refuelling Supervisor.
- GPU shall be stopped immediately (if applicable) and shall remain stationary until the spillage is removed and there is no danger from flammable vapours.
- ACU engine of the unit shall be stopped (if applicable), this is to prevent the possibility of flammable vapours being passed into the aircraft passenger compartments.
- Secure the area 15 meters from the contaminated area in order to reduce the risk of ignition.
- Coordinate as per Refuelling Supervisor disposal other actions to be taken.
- If safe to do so, mobilise fire fighting equipment as stand-by protection until the arrival of the airport emergency services.
- Inform a Company representative.

In case of fuel spillage when passengers are not on board the Refuelling Supervisor shall:

- Evacuate the personnel on duty on board through normal aircraft exits.
- Activate the emergency as per local regulation (if necessary).
- Inform a Company representative.

 ITA AIRWAYS Volume II HLM	RAMP HANDLING	8.6	Page 9
	REFUELLING	Ed 2/20 apr 2022	

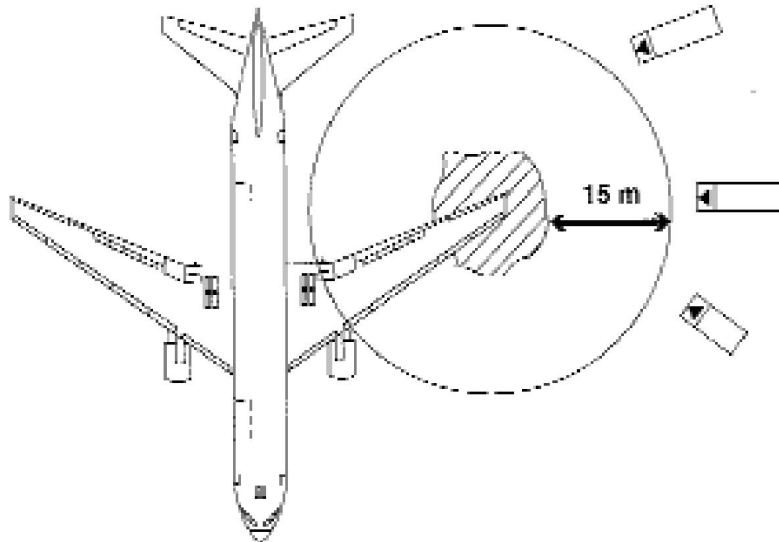

8.6.5.3 Fire on Ramp during refuelling

If a fire start during refuelling:

- Suspended immediately refuelling operations, and inform the Captain.
- Evacuate quickly all personnel and GSE servicing aircraft (except disembarking devices as passengers stairs and/or loading bridge) in order to leave all the aircraft emergency exits free for slides deployment.
- Fight the fire using fire extinguisher only if the situation is under control and is safe to act.

Note:

The Flight Deck shall adopt the necessary safety measures and inform the Control Tower of the actions taken to cope with the emergency.

If a fire start on ramp during refuelling without passengers on board, the Refuelling Supervisor shall:

- Evacuate the personnel on duty on board through normal aircraft exits.
- Activate the emergency as per local regulation (if necessary).
- Inform a Company representative.

Note:

If the Refuelling Supervisor is the Refuelling Handler representative himself, the evacuation of personnel on duty on board shall be coordinated by the Ground Staff (i.e. Ramp Agent).

 ITA AIRWAYS Volume II HLM	RAMP HANDLING	8.7	Page 1
	SURFACE TRANSPORTATION AND TRANSFER	Ed 2 Rev 5/02 nov 23	

8.7 SURFACE TRANSPORTATION AND TRANSFER

8.7.1 INTRODUCTION

When Company's cargo, mail and baggages (hereinafter "load") have to move between ground facilities and the aircraft, or between aircraft, apply the following procedures.

8.7.2 TRANSPORT FROM FACILITY TO AIRCRAFT

- a. Receive all documentation and/or instructions for the specific flight.
- b. Make sure that any GSE and equipment that you use are serviceable, before collecting loose loads and/or ULDs from the flight holding area.
- c. Inspect all loads to be moved to the flight(s). Check that:
 1. the load you intend to transport is the correct load for the flight(s).
 2. the load is undamaged and has no signs of being tampered, inform Company representative of any abnormalities.
 3. all ULDs are serviceable and fit for flight.
 4. no nets, ropes, straps, protective materials, etc. are in a position to drag on the ground, get jammed in rollers, ball-mats or wheels.
 5. all built-up ULDs are safe to move and will not shift, roll, or topple.
 6. all dollies comply with ULDs intended to transport, are serviceable and all latches/locks/stops are engaged to keep the ULDs on the dollies.
 7. all loose load is securely stowed and all handling instructions are obeyed (i.e. for dangerous goods separation of incompatible commodities is maintained at all times).
 8. in case of pallet stack, the maximum stacked unit number is 15.
- d. Protect load from adverse weather conditions by using a cover and/or avoiding the use of open carts.
- e. Comply with the following limitations regarding the maximum number of carts/dollies in a "train":
 - 5 carts for loose load,
 - 4 dollies for ULD type AKE, AKH, PKC, etc. + 1 cart for loose load,
 - 3 dollies for ULD type PMC, PAG, AAP, etc. + 2 carts for loose load.
 In any case, limit the number of carts and dollies in a train to the maximum specified by the local airport regulations.
- f. Inspect all load delivered to a flight with the aircraft loading staff, making sure no damage has occurred during the transport process. If damage has occurred, report it to the Company representative.
- g. Hand over all documentation, pouches and special instructions for that flight only, to the aircraft loading staff, in the aircraft hold and/or to cabin staff as per operating airline procedures.

8.7.3 TRANSPORT FROM AN AIRCRAFT TO OTHER AIRPORT AREA/TO OTHER AIRCRAFT

- a. Inspect all loads collected before moving it. Check that:
 1. the correct load is being collected.
 2. the load is undamaged and has no signs of being tampered, inform Company representative of any abnormalities.
 3. all ULDs are serviceable and fit for flight.
 4. no nets, ropes, straps, protective materials, etc. are in a position to drag on the ground,

 Volume II HLM	RAMP HANDLING	8.7	Page 2
	SURFACE TRANSPORTATION AND TRANSFER	Ed 2/20 apr 2022	

- get jammed in rollers, ball-mats or wheels. All built-up ULDs are safe to move and will not shift, roll, or topple.
5. All dollies comply with ULDs intended to transport, are serviceable and all latches/locks/stops are engaged to keep the ULDs on the dollies.
 6. all loose load is securely stowed and all handling instructions are obeyed (i.e. for dangerous goods separation of incompatible commodities is maintained at all times).
- b. Make sure all documentation, pouches and special instructions are collected from unloading staff.

LOADING AND TIE DOWN

 Volume II HLM	LOADING AND TIE DOWN	9.1	Page 1
	LOADING / UNLOADING	Ed 2 Rev 1/15 oct 2022	

9.1 LOADING / UNLOADING

9.1.1 SAFETY REQUIREMENTS SPECIFIC TO AIRCRAFT LOADING / UNLOADING OPERATIONS

During aircraft loading and unloading the following rules shall be followed:

- Prior to being loaded into an aircraft, check that ULDs are of a type approved for the specific aircraft type and there are no protrusions or overhangs that will damage the aircraft cargo door opening or the interior of the aircraft cargo hold.
- Both during unloading operation in arrival and before loading at departure, is mandatory to inspect the ULDs in order identify damage, and to determine airworthiness and serviceability, following the indication as reported in Chap. 6.2.4.
- ULD's door must be closed and locked into place prior to being loaded into the aircraft.
- ULDs must not be dirty when loaded (snow, wood, plastic, FOD, etc.).
- Respect the loading limitation of ULD.



Attention:

- only for A320F: before loading, verify that the eventual PKC plastic covering is intact, without cuts or tears, during flight parts of it could damage/clog vents installed in holds. In case of non-conformity, plastic covering shall be replaced or PKC shall not be loaded on board.

- Respect the limitation of aircraft structural load and area.
- All personnel assigned to operation of the CLS (Cargo Loading System) shall be trained in accordance with Company's requirements and technical instructions of such system.
- When loading ULDs make sure that the edges are either guided by the side rails or fit under the stops/locks/guides and that the height of the pallet allows for sufficient clearance in the

 Volume II HLM	LOADING AND TIE DOWN	9.1	Page 2
	LOADING / UNLOADING	Ed 2 Rev 5/02 nov 23	

door opening. Also check that the passage of the ULD's into their position is not obstructed by stops/locks/guides.

- When fastening pallet nets, although restraint must be resistant, do not exert so much force that the pallet bends, as this would make it impossible to restrain it to the floor with the locks.
- Load ULD in compartments so that container door faces the hold door, except for containers in the L/R positions (i.e. AKE).
- For odd sized or overhang cargo shipments, ensure the correct number of tie down straps have been used and that they are tight and the load is secure once has been loaded.
- When loading ULDs, manually handled or by CLS, full control of them shall be maintained as their impact against locks and stops at high speed can cause damage.
- Use tarpaulins or covered carts during inclement weather to protect load shipments.
- For bulk loading is mandatory to respect 5 cm/2 inch clearance between ceiling and loaded articles.
- In the case of bulk consignments that could cause liquid spillage (e.g. pes), the floor of hold 5 (fwd and aft in case of A320 neo full bulk) must be covered with protective plastic sheeting to protect the structure of the hold and other loaded material/baggage.
- The bulk load and ULDs are correctly secured and locks and nets are in use in a manner that prevents movement and/or spillage during flight.
- Ensure cargo not accommodated on the flight is returned to its proper location.
- Always observe the specific instruction labels and marks such as FRAGILE, TOP, THIS SIDE UP, etc.
- Report torn (or missing) baggage tags and cargo labels, and do not load unless corrected.
- Report immediately any damage to the load, whether it occurs during handling or is noticed on arrival.
- Get assistance when moving heavy articles (place them on the bottom) and always use special equipment (tie down straps, planks, etc.) for loading in compartment.
- Do not use baggage carts to gain access to cargo compartments.
- Holds and compartments shall only be entered or exited by using the appropriate elevating device and which has been positioned and secured, e.g. belt conveyor and cargo loader.
- Do not walk between dollies or carts being towed, or when they are stationary on the ramp.

 Volume II HLM	LOADING AND TIE DOWN	9.1	Page 3
	LOADING / UNLOADING	Ed 2 Rev 14/05 jun 25	

- Do not drive loaded baggage carts or dollies under the aircraft fuselage.



Caution:

Damage to the aircraft may result from:

- exceeding aircraft floor load limitations
- inadequate tie down and failure to fasten separation nets and door nets
- insufficient precautions when loading on seats in the passenger cabin
- incorrect opening or closing of doors and operation of cargo doors during strong or gusty wind conditions

- During loading or unloading, the attitude of an aircraft may vary, up or down. Make full allowance for this movement when handling equipment in close proximity (stands, carts, trucks, highloaders, conveyor belts, etc.).
- Be careful during loading and unloading operations, to avoid damage to the doors and door openings, the hold linings, and to cargo hold fire system protective covers.
- Take care when manoeuvring large or heavy items within the holds to prevent damage to the floor never use a crowbar or similar tool directly on the aircraft floor.

9.1.2 IDENTIFYING SHIPMENTS REQUIRING SPECIFIC HANDLING

All shipments requiring specific handling will be identified by the Load Agent on the LIR.

For examples of labels affixed to such shipments refer to Chapter 3 in this publication. When loading cargo with specific handling labels, every effort should be made so that these labels are visible.

9.1.3 CARGO HOLD INSPECTION

Prior and after loading/unloading operations, a check of all cargo holds must be conducted to inspect each cargo hold for:

- Damage to the compartment.
- Missing and/or unserviceable floor locks, nets or panels.
- Spills in the hold that may have occurred.
- Baggage or cargo that may have been left on board the aircraft.
- The holds are free of any foreign objects.

A check must be conducted in a hold even if on arrival the hold was reported as not carrying any cargo/baggage (empty).

If any anomaly is founded (i.e. dangerous goods mis-declared or undeclared during loading), it must be immediately reported to a supervisor and a Company representative. When applicable, loading limitations are determined by the Maintenance Department at the station or by the Cockpit Crew. The Load Controller shall be informed accordingly and take into consideration in the aircraft loading & weight & balance process if ULDs are to be loaded with any missing locks or latches.

 ITA AIRWAYS Volume II HLM	LOADING AND TIE DOWN	9.1	Page 4
	LOADING / UNLOADING	Ed 2 Rev 1/15 oct 2022	

9.1.4 COMPARTMENT SEPARATOR NETS AND CARGO DOOR BARRIER NET

It is mandatory that compartment separator nets be installed prior to all flight departures. This will separate compartments and prevent shifting of load during take-off and landing or during turbulence in flight.

Compartment nets shall be placed inside aircraft compartments and not left hanging outside, to avoid clips and attachment points from striking fuselage (especially during adverse weather conditions) or inadvertently hooked on GSE and pulled out of the aircraft.

Cargo door barrier nets must be installed prior to flight departure to prevent cargo from shifting in flight and damaging or blocking the compartment door.

9.1.5 CONTAINER/PALLET RESTRAINT SYSTEM

It is mandatory that all floor stops and pallet locks, required to secure containers and pallets, are extended and locked prior to any flight. This includes cargo holds that are empty.

Confirmation that this has been done will be given during load verification.



Caution:

A tactile check must be performed by physically checking the lock with your hands once the container has been locked into position.

9.1.6 SCALING PROCESS

If the Flight Crew experiences a handling irregularity on take-off, the Flight Crew may request aircraft scaling (weighing of all baggage and cargo on board) at the arrival station. Aircraft must not be unloaded when a scaling has been requested until the process has been initiated.

9.1.7 LEAKAGE INSPECTION BEFORE LOADING

Ensure hold baggage, ULDs and/or equipment, prior to release for loading into the aircraft are inspected for signs of substance leakage, and, if leakage of dangerous goods is found, such baggage and/or equipment is prevented from release for loading into the aircraft in accordance with requirements of the Company and:

- an evaluation is conducted to identify and prevent from transport any other baggage or equipment that has become contaminated by such leakage,
- a notification is made to a Company representative and to the applicable Authority.

9.1.8 LEAKAGE IN CARGO COMPARTMENTS

Spills can occur in cargo compartments during loading/unloading operations and in flight due to, for example but not limited to, improper packaging, damage due to mishandling prior to loading and improper loading in the compartment. If evidence of damage or leakage is found, the packages or ULDs must be removed from the aircraft without delay and an evaluation is conducted to identify and prevent from transport any other baggage, cargo or equipment that has become contaminated by such leakage.

 Volume II HLM	LOADING AND TIE DOWN	9.1	Page 5
	LOADING / UNLOADING	Ed 2/20 apr 2022	

Leakage can be:

- liquid, gels, or material in a powdered or granulated form.
- hazardous corrosive, flammable, explosive, toxic or poisonous, etc. Even water can cause serious damage to electrical components and systems.
- corrosive to the aircraft structure. Mercury spills are particularly corrosive to the extent that the affected aircraft structure may have to be completely replaced if not cleaned up quickly.

The Ramp Supervisor shall:

- conduct an evaluation to identify and prevent from transport any other baggage and/or equipment that has become contaminated by such leakage,
- report the leakage event to Captain or Maintenance, Company representative and applicable Authority, so that corrective action can be taken.

9.1.9 LOW WING AIRCRAFT

To prevent damage to aircraft with low wings (i.e. A220), baggage tractors shall stop approximately 1 meter (3 ft) from the belt loader to unlock the carts. Move the tractor away and position the carts by hand.

Take care when pulling or pushing carts especially when ramp conditions are slippery. When necessary obtain assistance.

When removing baggage carts, the tractor shall be positioned pointing away from the aircraft wing and the baggage cart pulled to the tractor

Extreme caution must be used when using covered baggage carts.

9.1.10 TIPPING PREVENTION

See Chap. 4.2.9 "TIPPING PREVENTION".

9.1.11 BLOW-OUT PANELS

Aircraft are provide with "Blow-out" panels; when operative, they provide an adequate aircraft pressure level in case of sudden depressurization throughout the flight, guaranteeing the safety. During handling operations, it must be paid attention and care in order to avoid any possible damage. Report immediately to Maintenance Technician, Captain or Company Representative any kind of damage or non- standard situations regarding the 'Blow-out panels'.

 ITA AIRWAYS Volume II HLM	LOADING AND TIE DOWN	9.1	Page 6
	LOADING / UNLOADING	Ed 2/20 apr 2022	

OK

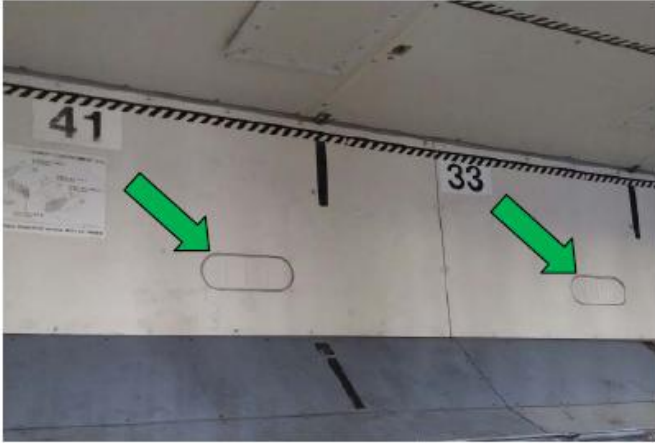

NOT OK (mandatory to report)



 ITA AIRWAYS Volume II HLM	LOADING AND TIE DOWN	9.2	Page 1
	BAGGAGE ASSISTANCE	Ed 2/20 apr 2022	

9.2 BAGGAGE ASSISTANCE

9.2.1 BAGGAGE RICONCILIATION

Passengers/baggage reconciliation must be performed for each flight, as specified here below:

- reconciliation for bulk baggage must be counted while loading on board the aircraft filling a document (Bingo Sheet or Baggage Reconciliation System summary report).
The baggage quantity must be written on the “Loading Instructions” form,
- reconciliation for containerized baggage must be performed at the sorting area while loading the ULD filling a document (Bingo Sheet or Baggage Reconciliation System summary report) which escorts the ULD and must be inserted in its side pocket. Eventual updates of the ULD content must be added to the same documents.
The baggage quantity must be written on the “Loading Instructions” form,
- the Ramp Agent must verify the match between the filled document and the actual load and distribution as reported on the “Loading Instructions” form.

 Volume II HLM	LOADING AND TIE DOWN	9.2	Page 2
	BAGGAGE ASSISTANCE	Ed 2 Rev 5/02 nov 23	

9.2.2 DISTRIBUTION CRITERIA

Mark both the destination and the type of transit on the ULD tag (even when it contain different types) and report the same in the “Supplementary Information” (SI) field on CPM and LDM messages.

9.2.2.1 Flights to FCO & LIN

Baggage distribution from outstation shall follow this segregation criteria:

- **BJ** - PRIORITY LOCAL baggage
- **BY** - ECONOMY LOCAL baggage.
- **BT** - TRANSIT baggage.
- **BH** - HUB BAGGAGE. Dedicated ULD (Tail to Tail or Group)
- **BG** - GATE BAGGAGE (baggage collected at gate).
- **BR** - RUSH BAGGAGE.
- **D** - CREW BAGGAGE

Codici aggiuntivi:

C - Cargo

E - Company Equipment

M - Mail

Q - Company Mail

 Volume II HLM	LOADING AND TIE DOWN	9.2	Page 3
	BAGGAGE ASSISTANCE	Ed 2 Rev 5/02 nov 23	

9.2.2.2 Flights with different destinations from FCO and LIN

Baggage distribution to all destinations other than FCO and MXP shall follow this criteria:

- **BJ** - PRIORITY LOCAL baggage
- **BY** - ECONOMY LOCAL baggage.
- **BT** - TRANSIT baggage.
- **BH** - HUB BAGGAGE. Dedicated ULD (Tail to Tail or Group)
- **BG** - GATE BAGGAGE (baggage collected at gate).
- **BR** - RUSH BAGGAGE.
- **D** - CREW BAGGAGE

9.2.3 ULD TAG

In order to identify correctly the load typology, is mandatory to place the Company ULD tag.

Is allowed to use different tags from the identification tag of the Company, both manual or generated by an automatic system, provided showing the same information shown on the automatic tag.

Note: It is recommended that all departments involved, which use a ULD TAG local printing system for each expected type (baggage, cargo, mail, DG) to keep a minimum extra stock, in order to ensure the use of such tags in case of local problems (i.e. blackout, lack of paper or ink).

Herewith the Company manual tag and one automatic example generated by a software system.

Note: For all ITA departing flights (originating and in transit), the tags affixed on the ULDs containing cargo, mail or company material shall indicate the gross weight (deadload net weight + ULD tare weight).

In case the company manual ULD tags are used (see Chap. 9.2.4), in the box weight the words "NET WEIGHT" shall be crossed out and the gross weight of C - M - E codes shall be indicated.

 ITA AIRWAYS Volume II HLM	LOADING AND TIE DOWN	9.2	Page 4
	BAGGAGE ASSISTANCE	Ed 2 Rev 3/26 may 23	

9.2.4 AUTOMATIC ULD TAG (example)



 858306FCO23096			BagManager Container Sheet		
Destination JFK John F. Kennedy International			Destination: JFK John F. Kennedy International Airport FCO AZ0610 06APR		
Flight FCO AZ0610 06APR			HUB HUB CONTAINER		
Transfers ATL DL1234 06APR			 858306FCO23096		
Container Type HUB HUB CONTAINER					
TEST			Transfers: ATL DL1234 06APR		
STD 14:50	Stand 605	Aircraft EIEJH	STD: Stand: 14:50 605		
IATA BagManager			Regn: EIEJH		
			Remarks: TEST		

 ITA AIRWAYS Volume II HLM	LOADING AND TIE DOWN	9.2	Page 6
	BAGGAGE ASSISTANCE	Ed 2 Rev 3/26 may 23	





 Volume II HLM	LOADING AND TIE DOWN	9.2	Page 8
	BAGGAGE ASSISTANCE	Ed 2 Rev 1/15 oct 2022	

9.2.5 LOADING SEQUENCE

The loading sequence on board shall be done in order to allow the baggage disembarkation in this sequence:

1. **BJ** (PRIORITY),
2. **BT** (SHORT to be specified in the comments box of the loadsheet),
3. **BY** (LOCAL),
4. **BT** (TRANSIT)
5. **BH/BG** (HUB baggage/Gate baggage)

9.2.6 LOADING INFORMATION CODES

The following codes shall be used on all documents and in traffic messages (Loading Instructions, ULD tags, CPM and LDM messages, etc.) to specify the different load categories:

	CODE	LOAD CATEGORY
PASSENGERS BAGGAGE	B	LOCAL baggage
	F	PRIORITY baggage
	S	SHORT-CONN baggage <70
	T	TRANSIT baggage >70
	G	TAIL TO TAIL TRANSIT baggage
	I	TRANSIT OUT OF U.S.A. baggage
CARGO	C	cargo
MAIL	M	mail
CREW BAGGAGE	D	crew baggage
COMPANY MATERIAL	E	Company material
SPECIAL CODES	X	Empty ULD in indicated position
	U	Out of service ULD in indicated position
	N	no ULD or load in indicated position or compartment

 ITA AIRWAYS Volume II HLM	LOADING AND TIE DOWN	9.2	Page 9
	BAGGAGE ASSISTANCE	Ed 2 Rev 6/15 nov 2023	

9.2.7 CODES FOR AVAILABLE CAPACITY OF ULD

CODE	AVAILABLE VOLUME
0	No available capacity (full ULD)
1	Available capacity above 1/4 of total
2	Available capacity above 1/2 of total
3	Available capacity above 3/4 of total

Note: capacity codes shall not be used for pallets.

9.2.8 CREW BAGS

Standard stowage of crew bags (crew on duty only) is as follows:

AIRCRAFT	COMPARTMENT
A350	5 (Bulk)
A330	51 (Bulk)
A320/A321	5 (Bulk)
A220	1 comp.A

 Volume II HLM	LOADING AND TIE DOWN	9.3	Page 1
	LOAD RESTRAINT	Ed 2/20 apr 2022	

9.3 LOAD RESTRAINT

9.3.1 GENERAL

Load is usually restrained by separation nets between sections or door protection nets. Nevertheless, certain type of loads must always be tied-down:

- All high density packages (sharp angles, steel extrusions, metallic trunks, etc.).
- HEA.
- Package(s) having large dimensions which prevent placing the transverse nets separating the sections. In this case the loads must be prevented from shifting by tying them down individually.
- Power driven wheelchairs (bulk compartment).
- AVI.
- Human remains (HUM).
- Dangerous Goods consignments (except when dimension and shape precludes tie-down).

Note

High density load is cargo with a density higher than 320 kg/m^3 , or lower but of piercing nature, due to shape and/or size.

There are four main forces which may cause the load to shift:

- a. Forward Movement: the restraint point of the load should be tied to a tie-down point behind the load.

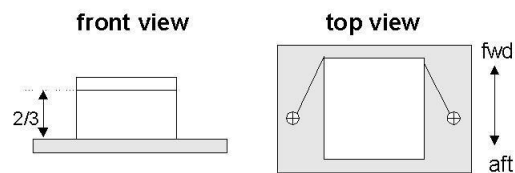

- b. Backward Movement: the restraint point of the load should be tied to a tie-down point forward of the load.

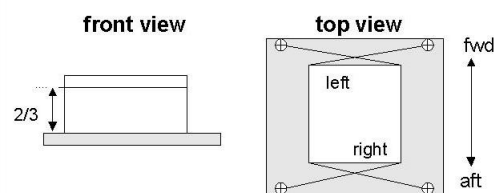
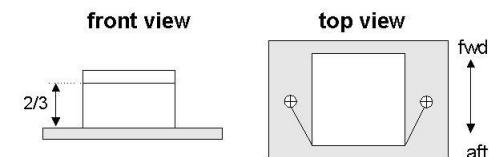

 Volume II HLM	LOADING AND TIE DOWN	9.3	Page 2
	LOAD RESTRAINT	Ed 2/20 apr 2022	

- c. Upward Movement: restraint should be obtained by tying a point as near as possible to the load to two opposite tie-down points, possibly having the cable pass over the load.

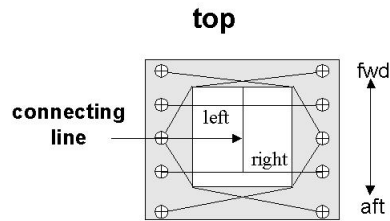

- d. Sideward Movement: restraint should be obtained by securing the cable to a point opposite the direction of the movement to be avoided.

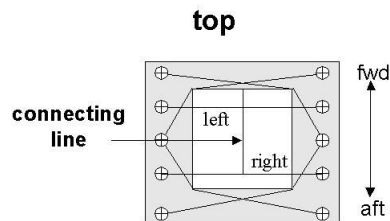

Therefore, dead load, both conventional and on pallets, must be securely restrained on board the aircraft in order to prevent it from shifting during flight operations.

 Volume II HLM	LOADING AND TIE DOWN	9.3	Page 3
	LOAD RESTRAINT	Ed 2/20 apr 2022	

9.3.2 TIE DOWN EQUIPMENT

A single tie-down fitting may receive up to 3 straps/ropes in three different restraint directions (one up and two opposite horizontal directions). Forces generated by the load can never act in more than one direction at the same time, and thus the fitting will never be pulled by more than one strap/rope at the same time. Therefore a fitting may never receive more than one strap/rope in the same direction (see fig.A).

Figure A

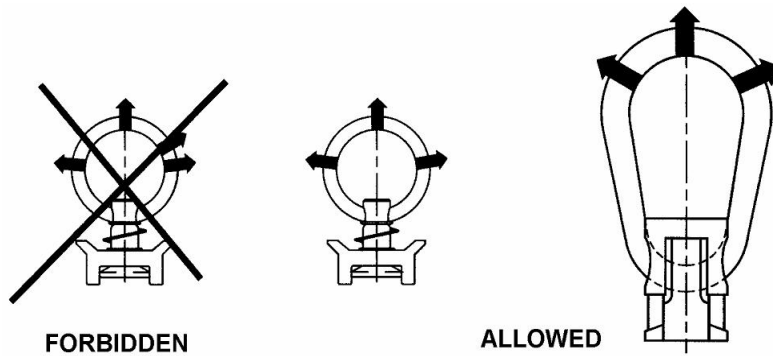

Figure B: Track

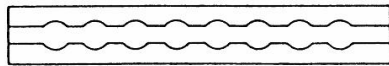

Figure C: Anchor Plate

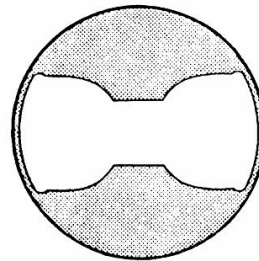

Figure D: Stud Fitting



Figure E: Stud Fitting

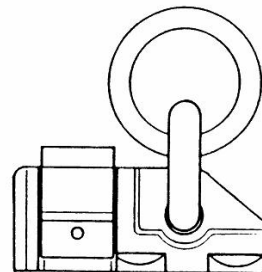

Figure F: Outboard side lock

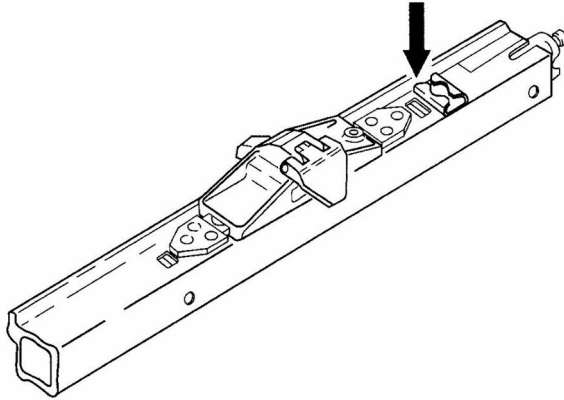
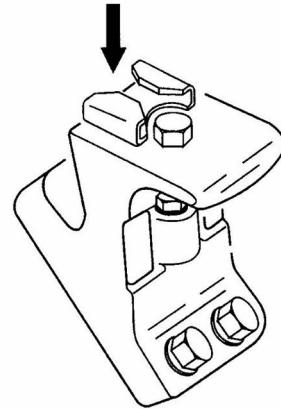

Figure G: Side guide



9.3.3 LOAD RESTRAINT FACTORS

in order to provide adequate resistance to the various forces dead load may be subject to under critical conditions, the load must be restrained in such a way that it will resist certain forces in all directions, indicated by a factor expressed in "G", known as "restraint factor".

Restraint capacity is reduced if the restraint device (strap) forms an angle with the direction of the force.

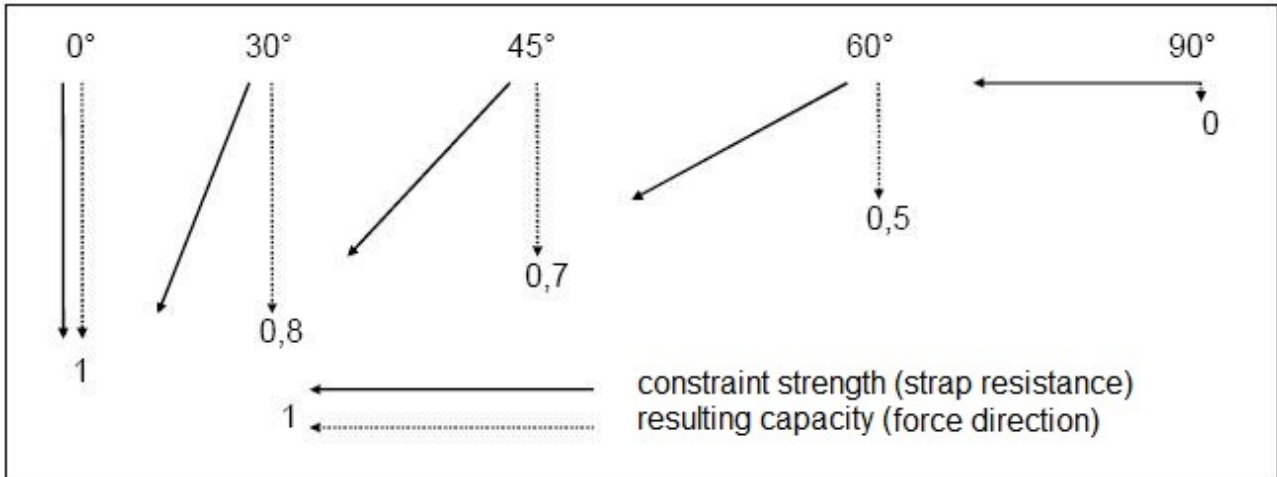

The factor of proportionality which reduces restraint capacity is shown in the following table:

Angle (90°-α)	Factor of proportionality	2.000 lb / 907 Kg strap	5.000 lb / 2.268 Kg strap
0°	1	2.000 / 907	5.000 / 2.268
30°	0,8	1.600 / 726	4.000 / 1.814
45°	0,7	1.400 / 635	3.500 / 1.588
60°	0,5	1.000 / 453	2.500 / 1.134
90°	0	0 / 0	0 / 0

As a practical example let us consider a restraint strap of a capacity of 5.000 lb (2.268 Kg); if the strap forms a 30° angle with the load to be restrained, the actual restraint capacity is of:

$$5,000 \times 0.8 = 4,000 \text{ lb. } (2.268 \times 0.8 = 1.814 \text{ Kg}).$$

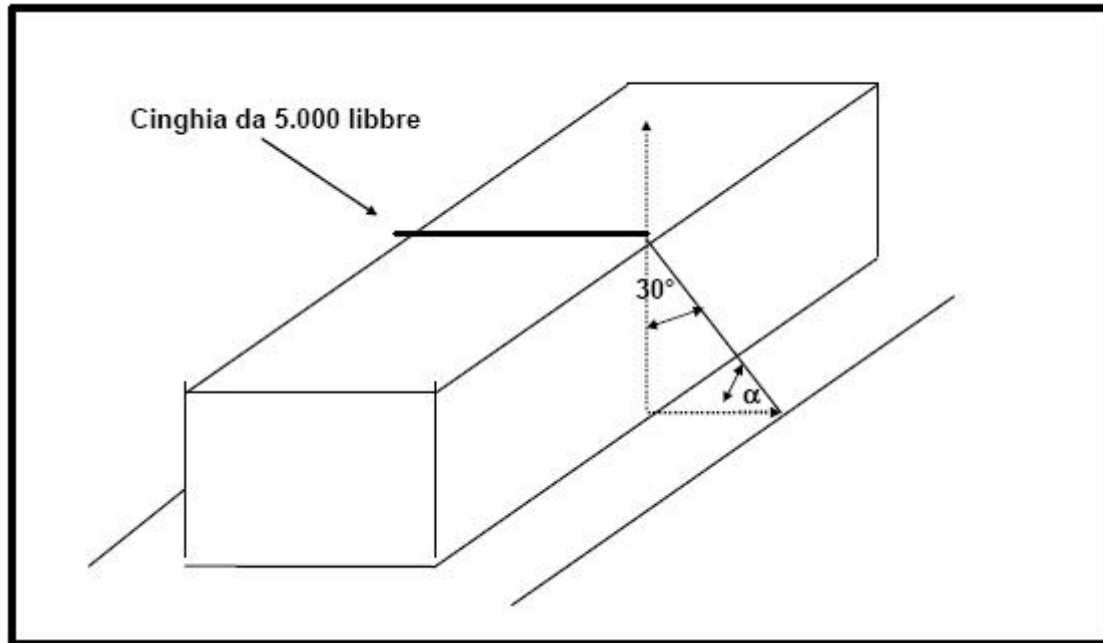

If, for practical reasons, it is more convenient to refer to the opposite angle (indicated by α) in the fig. above), the factors which must be applied are the following ones:

Angle (α)	Factor of proportionality	2.000 lb / 907 Kg strap	5.000 lb / 2.268 Kg strap
0°	0	0 / 0	0 / 0
30°	0,5	1.000 / 453	2.500 / 1.134
45°	0,7	1.400 / 635	3.500 / 1.588
60°	0,8	1.600 / 726	4.000 / 1.814
90°	1	2.000 / 907	5.000 / 2.268